

Yealink



Yealink VC800 Full HD Video Conferencing System User Guide

Version 30.6
Jun.2017

Copyright

Copyright © 2017 YEALINK (XIAMEN) NETWORK TECHNOLOGY

Copyright © 2017 Yealink (Xiamen) Network Technology CO., LTD. All rights reserved. No parts of this publication may be reproduced or transmitted in any form or by any means, electronic or mechanical, photocopying, recording, or otherwise, for any purpose, without the express written permission of Yealink (Xiamen) Network Technology CO., LTD. Under the law, reproducing includes translating into another language or format.

When this publication is made available on media, Yealink (Xiamen) Network Technology CO., LTD. gives its consent to downloading and printing copies of the content provided in this file only for private use but not for redistribution. No parts of this publication may be subject to alteration, modification or commercial use. Yealink (Xiamen) Network Technology CO., LTD. will not be liable for any damages arising from use of an illegally modified or altered publication.

Trademarks

Yealink®, the logo and the name and marks is trademark of Yealink (Xiamen) Network Technology CO., LTD, which are registered legally in China, the United States, EU (European Union) and other countries.

All other trademarks belong to their respective owners. Without Yealink's express written permission, recipient shall not reproduce or transmit any portion hereof in any form or by any means, with any purpose other than personal use.

Warranty

(1) **Warranty**

THE SPECIFICATIONS AND INFORMATION REGARDING THE PRODUCTS IN THIS GUIDE ARE SUBJECT TO CHANGE WITHOUT NOTICE. ALL STATEMENTS, INFORMATION, AND RECOMMENDATIONS IN THIS GUIDE ARE BELIEVED TO BE ACCURATE AND PRESENTED WITHOUT WARRANTY OF ANY KIND, EXPRESS OR IMPLIED. USERS MUST TAKE FULL RESPONSIBILITY FOR THEIR APPLICATION OF PRODUCTS.

(2) **Disclaimer**

YEALINK (XIAMEN) NETWORK TECHNOLOGY CO., LTD. MAKES NO WARRANTY OF ANY KIND WITH REGARD TO THIS GUIDE, INCLUDING, BUT NOT LIMITED TO, THE IMPLIED WARRANTIES OF MERCHANTABILITY AND FITNESS FOR A PARTICULAR PURPOSE. Yealink (Xiamen) Network Technology CO., LTD. shall not be liable for errors contained herein nor for incidental or consequential damages in connection with the furnishing, performance, or use of this guide.

(3) **Limitation of Liability**

Yealink and/or its respective suppliers are not responsible for the suitability of the information contained in this document for any reason. The information is provided "as is", and Yealink does not provide any warranty and is subject to change without notice. All risks other than risks caused by use of the information are borne by the recipient. In no event, even if Yealink has been suggested the occurrence of damages that are direct, consequential, incidental, special, punitive or whatsoever (Including but not limited to loss of business profit, business interruption or loss of business information), shall not be liable for these damages.

End User License Agreement

This End User License Agreement ("EULA") is a legal agreement between you and Yealink. By installing, copying or otherwise using the Products, you: (1) agree to be bounded by the terms of this EULA, (2) you are the owner or an authorized user of the device, and (3) you represent and warrant that you have the right, authority and capacity to enter into this agreement and to abide by all its terms and conditions, just as if you had signed it. The EULA for this product is available on the Yealink Support page for the product.

Patent Information

China, the United States, EU (European Union) and other countries are protecting one or more patents of accompanying products and/or patents being applied by Yealink.

Customer Feedback

We are striving to improve our documentation quality and we appreciate your feedback. Email your opinions and comments to DocsFeedback@yealink.com.

Technical Support

Visit Yealink WIKI (<http://support.yealink.com/>) for the latest firmware, guides, FAQ, Product documents, and more. For better service, we sincerely recommend you to use Yealink Ticketing system (<https://ticket.yealink.com>) to submit all your technical issues.

GNU GPL INFORMATION

Yealink VC800 video conferencing system firmware contains third-party software under the GNU General Public License (GPL). Yealink uses software under the specific terms of the GPL. Please refer to the GPL for the exact terms and conditions of the license.

The original GPL license, source code of components licensed under GPL and used in Yealink products can be downloaded online:

<http://www.yealink.com/GPLOpenSource.aspx?BaseInfoCateId=293&NewsCateId=293&CateId=293>.

About This Guide

Thank you for choosing the Yealink VC800 full HD video conferencing system. It is an all-in-one unit that supports 1080P-full HD video conferencing and includes outstanding features such as good compatibility, easy deployment and intelligent network adaptability. These make it the best choice for SME.

The Yealink VC800 full HD video conferencing system is designed to help enterprises organize video conferences easily and efficiently. Users can expect to enjoy the high-quality video conferencing experience very cost-effectively.

This guide provides everything you need to start using your new video conferencing system quickly. First, verify with your system administrator that the IP network is ready for system configuration. Also be sure to read the **Overview** and **Getting Started** sections in this guide before you set up and use the VC800 video conferencing system.

See the [Yealink Products Regulatory Notices Guide](#) for all regulatory and safety guidance.

Chapters in This Guide

Topics provided in this guide include:

- Chapter 1 [Overview](#)
- Chapter 2 [Getting Started](#)
- Chapter 3 [Customizing the VC800 Video Conferencing System](#)
- Chapter 4 [Using the VC800 Video Conferencing System](#)
- Chapter 5 [Video Conference Platform](#)
- Chapter 6 [Using the CPW90 Wireless Expansion Mic](#)
- Chapter 7 [Using the CPE90 Wired Expansion Mic](#)
- Chapter 8 [Troubleshooting](#)

Documentations

The following table shows documentations available for the VC800 video conferencing system.

Note

You can download the latest documents online:

<http://support.yealink.com/documentFront/forwardToDocumentDetailPage?documentId=196>.

Name	Contents	Where found	Language
Yealink VC800 Full HD Video Conferencing System Quick Start Guide	System installation and network configuration	On the website/ In the package	English/Chinese
Yealink VC800 Full HD Video Conferencing System User Guide	System/Web user interface settings Customizing and using the system	On the website	English/Chinese
Yealink VC800 Video Conference Room Deployment Solution	Conference room layout, environmental requirements and installation recommendations for the system	On the website	English/Chinese
Yealink VC800 Full HD Video Conferencing System Network Deployment Solution	Network deployment for the VC800 under various scenarios	On the website	English/Chinese
Yealink VC800 Full HD Video Conferencing System Administrator Guide	Functionality and configuration of the Yealink VC800	On the website	English/Chinese
Yealink VCR11 Remote Control Quick Reference Guide	Using the VCR11 Remote Control	On the website	English/Chinese
Yealink CPW90 Quick Start Guide	How to work with CP960 conference phone	On the website	English/Chinese

Name	Contents	Where found	Language
Yealink CP960 HD IP Conference Phone Quick Reference Guide	How to use CP960 conference phone.	On the website	English/Chinese

Typographic Conventions

Yealink documentations contain a few typographic conventions.

You need to know the following basic typographic conventions to distinguish types of in-text information:

Convention	Description
Bold	Highlights the web/phone user interface items such as menus, menu selections, soft keys, or directory names when they are involved in a procedure or user action (e.g., Click on Setting -> General). Also used to emphasize text
Blue Text	Used for cross references to other sections within this documentation (e.g., refer to Troubleshooting).
<i>Blue Text in Italics</i>	Used for hyperlinks to Yealink resources outside of this documentation such as the Yealink documentations (e.g., For more information, refer to Yealink VC800 Full HD Video Conferencing System Administrator Guide).

You also need to know the following writing conventions to distinguish conditional information:

Convention	Description
->	Indicates that you need to select an item from a menu. For example, Settings->Basic Settings indicates that you need to select Basic Settings from the Settings menu.

Terms

As you read this guide, you'll notice that the same terms are used repeatedly. Make sure you familiarize yourself with these terms.

Cloud platform: This term refers to Yealink VC Cloud Management Service, Yealink Meeting Server, Zoom, BlueJeans, Pexip, Mind and Custom platform.

Cloud account: This term refers to Yealink Cloud, YMS, BlueJeans, Pexip, Mind and Custom account.

Cloud contact: This term refers to Yealink Cloud contact and YMS contact.

Summary of Changes

This section describes the changes to this guide for each release and guide version.

Changes for Release 30, Guide Version 30.6

Major updates have occurred to the following sections:

- [Multipoint License](#) on page 93
- [Conference Management](#) on page 102

Table of Contents

About This Guide v

Chapters in This Guide.....	v
Documentations	vi
Typographic Conventions.....	vii
Terms	vii
Summary of Changes	viii
Changes for Release 30, Guide Version 30.6	viii

Table of Contents..... ix

Overview 1

Packaging Contents	1
VC800 Package	1
CP960+CPW90 Package.....	3
CP960+CPE90 Package.....	4
System Component Instructions.....	5
VC800 Codec	5
VCH50 Video Conferencing Hub.....	7
CP960 Conference Phone.....	9
CPW90 Wireless Conferencing Microphone.....	11
CPE90 Wired Expansion Mic.....	12
VCR11 Remote Control	13
Icon Instructions.....	15
Icons on Display Device	15
Icons on CP960 Conference phone	17
LED Instructions.....	18
User Interfaces.....	19
Web User Interface.....	19
Remote Control	20

Getting Started..... 21

Connecting the VC800 Video Conferencing System	21
Connecting the VC800 Codec.....	22
Connecting the Audio Device	23
Installing the VC800 Video Conferencing System	24
Mounting the VC800 Codec on a TV	24

Mounting the VC800 Codec on a Wall	25
Installing Batteries for the Remote Control.....	26
Remote Control Battery Safety Information.....	26
Powering the System On	26
Put the System to Sleep	27
Powering the System Off	28
Setup Wizard	28
Controlling Local Camera	29
Registration	29
Idle Screen	30
Idle Screen of VC800 Video Conferencing System.....	30
Idle Screen of CP960 Conference phone.....	31
Navigating Menus and Fields.....	32
Navigating the Display Device.....	32
Navigating the CP960 Conference phone	32
Entering Data and Editing Fields.....	35
Entering Data and Editing Fields Using Remote Control.....	35
Entering Data and Editing Fields Using CP960	37
System Status	42

Customizing the VC800 Video Conferencing System.....45

General Settings	45
Automatic Sleep Time.....	45
Backlight.....	46
Screen Saver.....	48
Site Name.....	48
Language.....	49
Time & Date.....	50
Key Tone.....	54
Website Snapshot.....	55
Adjusting Zoom Level of the Display Device	55
Volume Settings	56
Hiding IP Address	59
Hiding Heading Time	60
Hiding Icons in a Call.....	61
Custom Key Type	61
USB Configuration	62
Directory	63
Adding Contacts.....	64
Placing Calls to Contacts.....	66
Editing Contacts	68
Deleting Contacts	69
Searching for Contacts	71

Search Source List in Dialing	72
Importing/Exporting Local Contact Lists	74
Call History Management	77
Viewing Call History	77
Placing a Call from the Call History List	79
Deleting an Entry from the Call History List	80
Adding a Local Contact from the Call History List	82
Call Protocol	84
Bandwidth Settings	85
Audio Setting	86
Audio Output Device	86
Audio Input Device	88
Far Control Near Camera	89
Controlling the Remote Camera	89
Using the VC800 Video Conferencing System.....	91
Account Polling	91
Multipoint License	93
Placing Calls	96
Placing a Call Using the Remote Control	97
Placing a Call Using the CP960 conference phone	98
Placing a Call via Web User Interface	99
Initiating a Conference	99
Conference Management	102
Conference Type	102
Meeting Password	105
Joining the Meeting	106
Meeting Whitelist	106
Meeting Blacklist	107
Editing Number before Calling	108
Answering or Rejecting Calls	110
Auto Answer	110
Do Not Disturb (DND)	112
Ending Calls	114
Call Management	116
Call Mute	116
Network Quality Tip	117
Call Statistics	117
Changing the Video Input Source	118
Presentation	119
Configuring Camera Presets	120
Video Recording	125
Screenshot	129

Video Layout.....	131
Video Conference Platform.....	139
Using the Yealink VC Cloud Management Service Platform	139
Dialing Yealink Cloud Accounts	139
Using the Yealink Meeting Server	141
Dialing YMS Accounts.....	141
YMS Video Conference.....	142
Using the StarLeaf Cloud Platform.....	160
Dialing StarLeaf Cloud Numbers	160
Joining the StarLeaf Meeting	162
Using the Zoom Cloud Platform	163
Joining the Zoom Meeting.....	163
Using the BlueJeans Cloud Platform	165
Joining the BlueJeans Meeting.....	165
Using the Pexip Platform	166
Dialing Pexip Alias	166
Joining the Pexip Meeting.....	168
Using the Mind Platform.....	169
Joining the Mind Meeting	169
Using the Custom Platform.....	171
Using the CPW90 Wireless Expansion Mic	173
LED Instructions.....	173
Placing the CPW90	174
Charging the CPW90	174
Turning the CPW90 On or Off	175
Registering CPW90 with the CP960 Conference Phone.....	175
Viewing CPW90 Information	177
Muting or Unmuting the CPW90.....	179
Finding the Registered CPW90.....	179
Working Frequency	179
Using the CPE90 Wired Expansion Mic	181
Placing the CPE90	181
Muting or Unmuting the CPE90.....	181
Troubleshooting.....	183
System Diagnostics	183
General Issues.....	186
Camera Issues.....	187

Display Issues.....188

Video & Audio Issues189

System Maintenance190

Regulatory Notices197

 Service Agreements197

 Limitations of Liability197

 Safety Instructions197

 Restriction of Hazardous Substances.....199

Appendix A - Time Zones.....201

Index.....205

Overview

This chapter provides an overview of the VC800 video conferencing system. Topics include:

- [Packaging Contents](#)
- [System Component Instructions](#)
- [Icon Instructions](#)
- [LED Instructions](#)
- [User Interfaces](#)

If you require additional information, or assistance to help you use your new system, contact your system administrator.

Packaging Contents

You can purchase any combination according to your needs:

- **VC800+CP960+CPW90**
- **VC800+CP960+CPE90**

CP960 conference phone can work as an audio device for the VC800 system. You can also place calls, answer calls or view directory and history on the CP960 conference phone.

Note

We recommend that you use the accessories and cables provided or approved by Yealink. The use of unapproved third-party accessories may result in reduced performance.

VC800 Package

- **VC800 Codec**

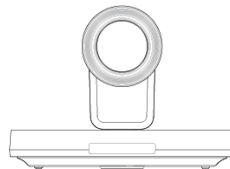

- **VCH50 Video Conferencing Hub**



- **L-Bracket** (for installing the camera)

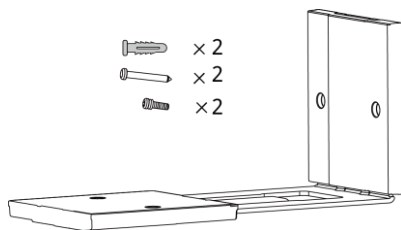

- **VCR11 Remote Control**



- **AAA Batteries x 2**



- **Power Adapter and Power Cord**

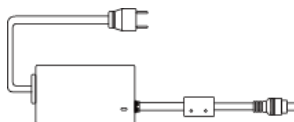

- **Velcro x 2**



- **Network Cables**

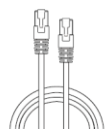

7.5m Network Cable

(connecting VC800 Codec to VCH50 Video Conferencing Hub or CP960 Conference Phone)

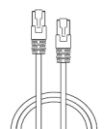

3m Network Cable

(connecting to the Internet)

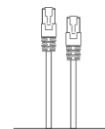

0.5m Network Cable

(connecting VCH50 Video Conferencing Hub to CP960 Conference Phone)

- **1.8m HDMI Cable×2** (for TV)

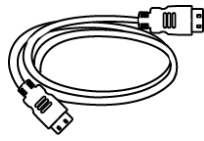

- **1.5m HDMI Cable** (for Content Sharing)

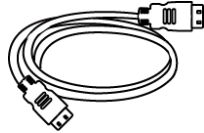

- **1.8m Mini DP Cable** (for Content Sharing)

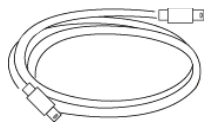

- **Cable Ties×5**



- **VC800 Quick Start Guide**

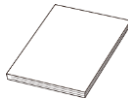

CP960+CPW90 Package

- **CP960 Conference Phone**

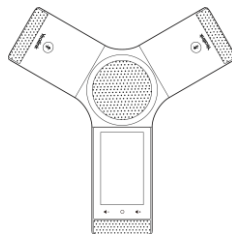

- **Wireless Expansion Mic ×2**

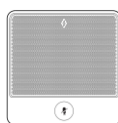

- **Charging Cradle**

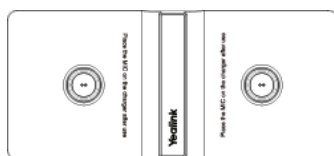

- **0.3m Micro USB Cable**

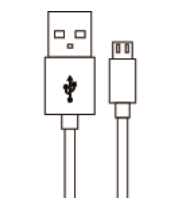

- **CPW90 Wireless Expansion Mic Quick Start Guide**

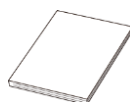

CP960+CPE90 Package

- **CP960 Conference Phone**

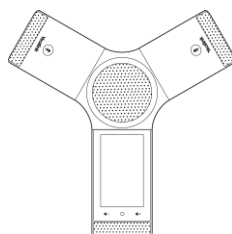

- **Wired Expansion Mic×2**

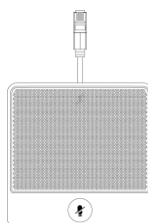

System Component Instructions

Before installing and using the VC800 video conferencing system, you need to be familiar with the following system components, including:

- [VC800 Codec](#)
- [VCH50 Video Conferencing Hub](#)
- [CP960 Conference Phone](#)
- [CPW90 Wireless Conferencing Microphone](#)
- [CPE90 Wired Expansion Mic](#)
- [VCR11 Remote Control](#)

VC800 Codec

VC800 codec compresses outgoing video and audio data, transmits this information to the far end, and decompresses incoming data. It supports 16:9 and 4:3 aspect ratios. It can be compatible with different audio output devices, and can adapt to the display devices automatically.

The front of VC800 codec

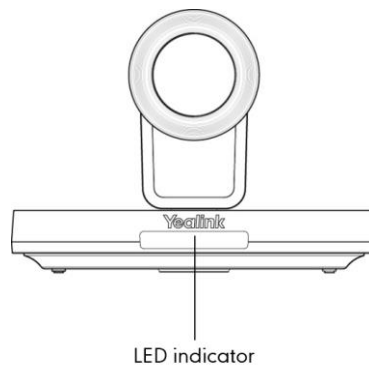

The HD camera supports 12x optical zoom, white balance and automatic gain. You can place the VC800 on the table or mount it on a wall. The LED indicator in front of the camera indicates different statuses of the system. For more information, refer to [LED Instructions](#) on page 18.

You can use the remote control to adjust the position or focus of the camera. The VC800 camera can be panned (± 100 degrees range), tilted (± 30 degrees range).

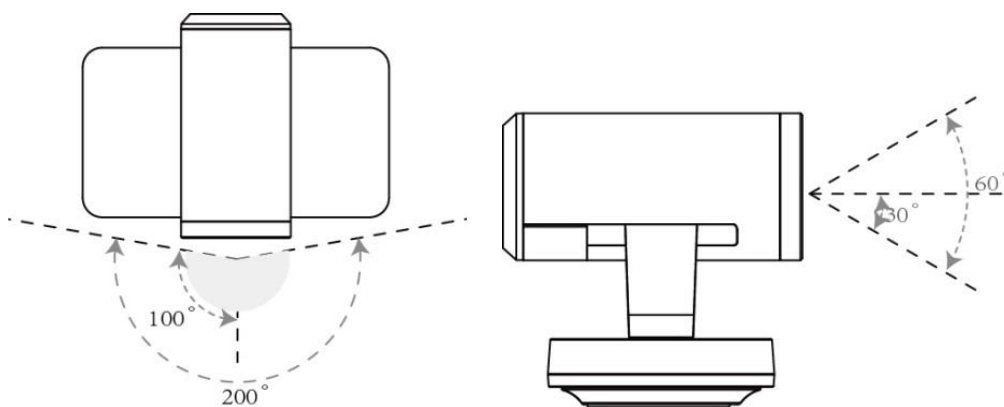

Infrared Sensor

The infrared sensor is located within the Yealink logo. Aim the remote control at the camera IR sensor to operate the unit.

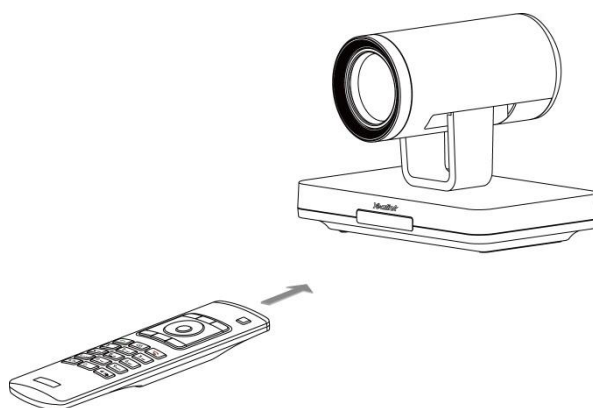

The back of VC800 codec:

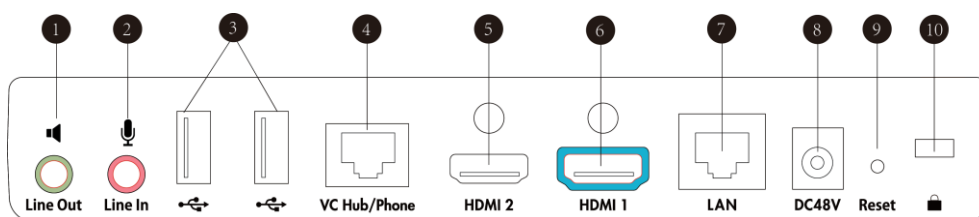

	Port Name	Description
①	Line Out	Connects to an audio output device using an audio cable (3.5mm).
②	Line In	Connects to an audio input device using an audio cable (3.5mm).
③	USB	Inserts a USB flash drive to one of the two USB ports for storing screenshots, recording videos or capturing packets.

	Port Name	Description
		Note: If two USB flash drives are connected, only the latter one can be identified.
④	VC Hub/Phone	<ul style="list-style-type: none"> If you want to share contents, connect this port to the Codec port on the VCH50 video conferencing hub. If you need an audio device, connect this port to the Internet port on the CP960 Conference phone.
⑤	HDMI 1	Connects to a display device for displaying video images.
⑥	HDMI 2	Connects to secondary display device for displaying video images.
⑦	LAN	Connects to the network device.
⑧	DC48V	Connects to the power source via a power adapter.
⑨	Reset Key	Resets the system to factory defaults.
⑩	Security Slot	Allows you to connect a universal security cable to VC800 codec, so you can lock it down. The system cannot be removed when locked.

VCH50 Video Conferencing Hub

The left side of cable hub:

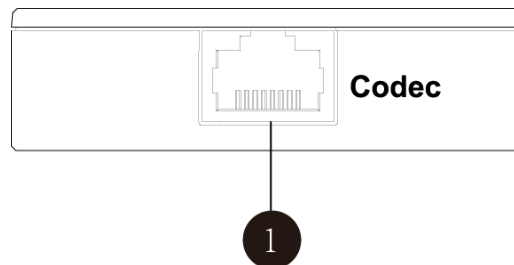

	Port Name	Description
①	Codec	Connects to the VC800 codec using a 7.5m network cable.

The right side of cable hub:

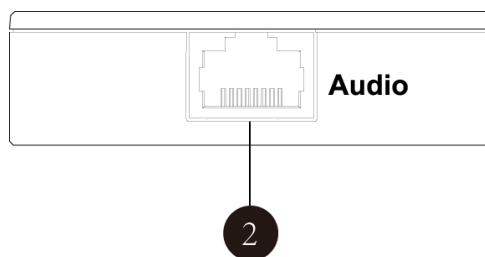

	Port Name	Description
②	Audio	Connects to the CP960 Conference phone using a 0.5m network cable.

The back of cable hub:

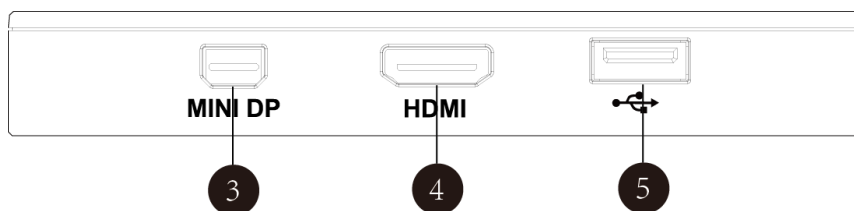

	Port Name	Description
③	MINI DP	Connects to a PC using mini DP cable for sharing contents.
④	HDMI	Connects to a PC using HDMI cable for sharing contents.
⑤	USB	Inserts a USB flash drive to the USB port for storing screenshots, recording videos or capturing packets.

CP960 Conference Phone

The CP960 Conference phone supports 360-degree audio pickup at a radius of up to 6 meters. Connect the CP960 conference phone to the VC800 codec. It can work as an audio device for the system. You can also place calls, answer calls or view directory and history on the CP960 conference phone.

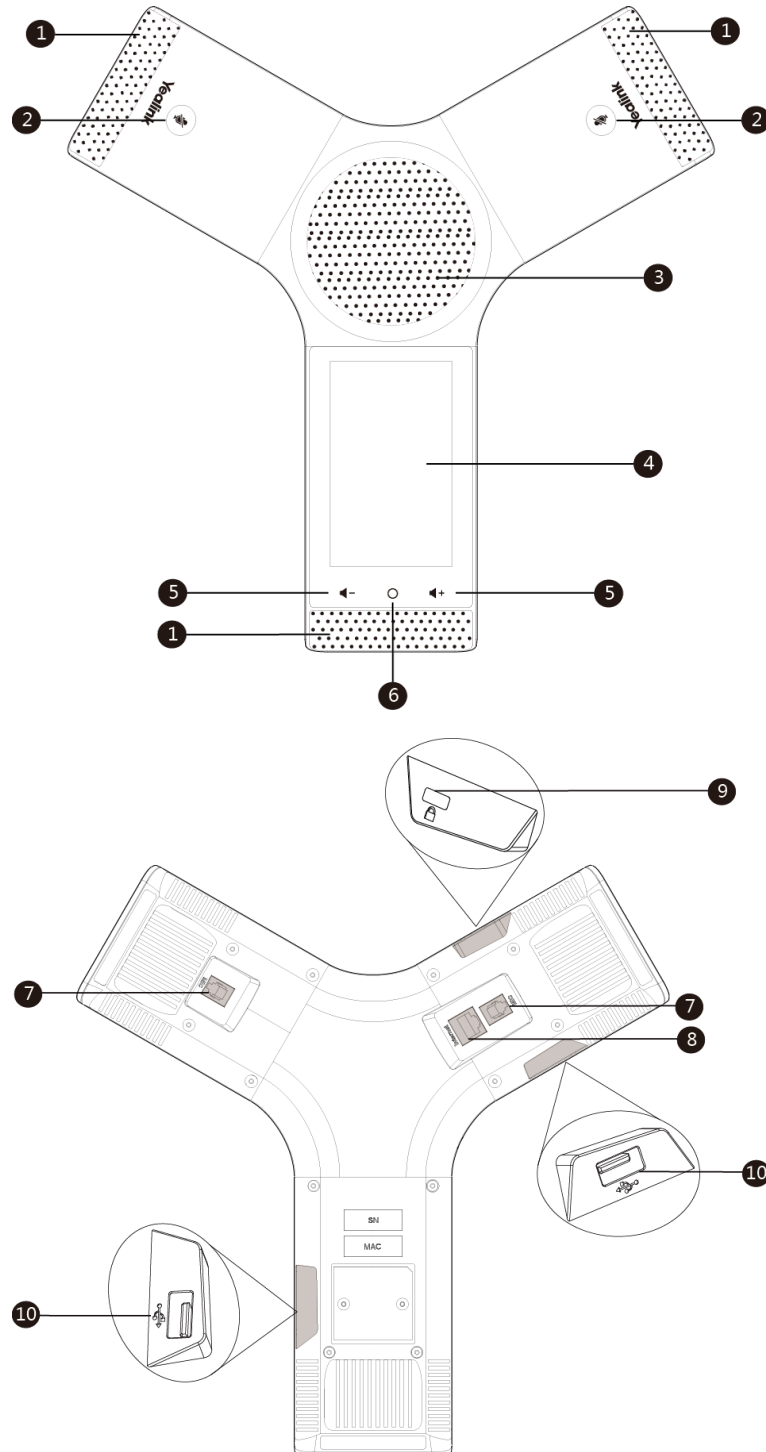

	Name	Description
①	Built-in Microphone	Supports 360-degree audio pickup at a radius of up to 6 meters.
②	Mute Button	Mutes or unmutes the CP960. For more information on the mute indicator LED, refer to LED Instructions on page 18.
③	Speaker	Provides audio output.
④	Touch Screen	Shows information about time and date, icons, conference information, application, call information and other relevant information.
⑤	Volume Touch Key	Adjusts the volume of the speaker, ringer or media.
⑥	HOME Touch Key	Returns to the idle screen.
⑦	MIC Ports	Connect to two wired expansion microphones.
⑧	Internet Port	<ul style="list-style-type: none"> Connect the VC Hub/Phone port on the VC800 codec. Connect to the Audio port on the VCH50 video conferencing hub.
⑨	Security Slot	Allows you to connect a universal security cable to lock down your phone. The phone cannot be removed when locked.
⑩	USB Port	<ul style="list-style-type: none"> Inserts a USB flash drive to one of the two USB ports for storing screenshots, recording videos or capturing packets. Connects to the mini USB port on the charge cradle to charge the CPW90 wireless expansion mic. <p>Note: If two USB flash drives are connected, only the latter one can be identified.</p>

CPW90 Wireless Conferencing Microphone

The CPW90 is a wireless expansion mic which can work as the audio input device. It supports 360-degree audio pickup at a radius of up to 3 meters. There are a mute button and a battery indicator LED on its top. You can mute or unmute the CPW90 by tapping the mute button. This mute button is also a switch. You can turn off the CPW90 if it is not in use for a long period of time.

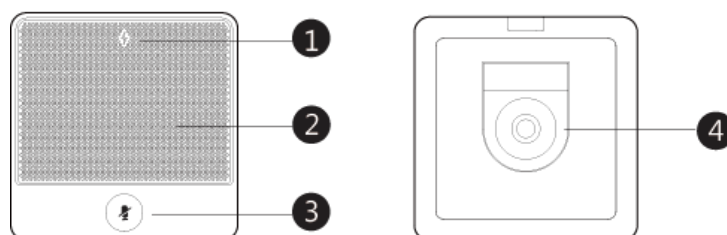

	Name	Description
①	Battery Indicator LED	Indicates the battery information. For more information on
②	Built-in Microphone	Supports 360-degree audio pickup at a radius of up to 3 meters.
③	Mute Button	<ul style="list-style-type: none"> Turns on or off the CPW90. Mutes or unmutes the CPW90. For more information on the mute indicator LED, refer to LED Instructions on page 173.
④	Charging Slot	Put the CPW90 on the charging cradle to charge.

For more information on how to use CPW90 Wireless Expansion Mic, refer to [Using the CPW90 Wireless Expansion Mic](#) on page 173.

CPE90 Wired Expansion Mic

The CPE90 can work as expansion microphone of the CP960 conference phone. It supports 360-degree audio pickup at a radius of up to 3 meters. There is a mute button on its top. You can mute or unmute the CPE90 by tapping the mute button during a call.

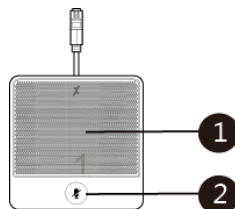

	Name	Description
①	Built-in Microphones	Support 360-degree audio pickup at a radius of up to 3 meters.
②	Mute Button	Mutes or unmutes the CPE90. For more information on the mute indicator LED, refer to LED Instructions on page 18.

For more information on how to use CPE90 Wired Expansion Mic, refer to [Using the CPE90 Wired Expansion Mic](#) on page 181.

VCR11 Remote Control

The VCR11 remote control helps users organize conference easily with intuitive and efficient operation in all screens.

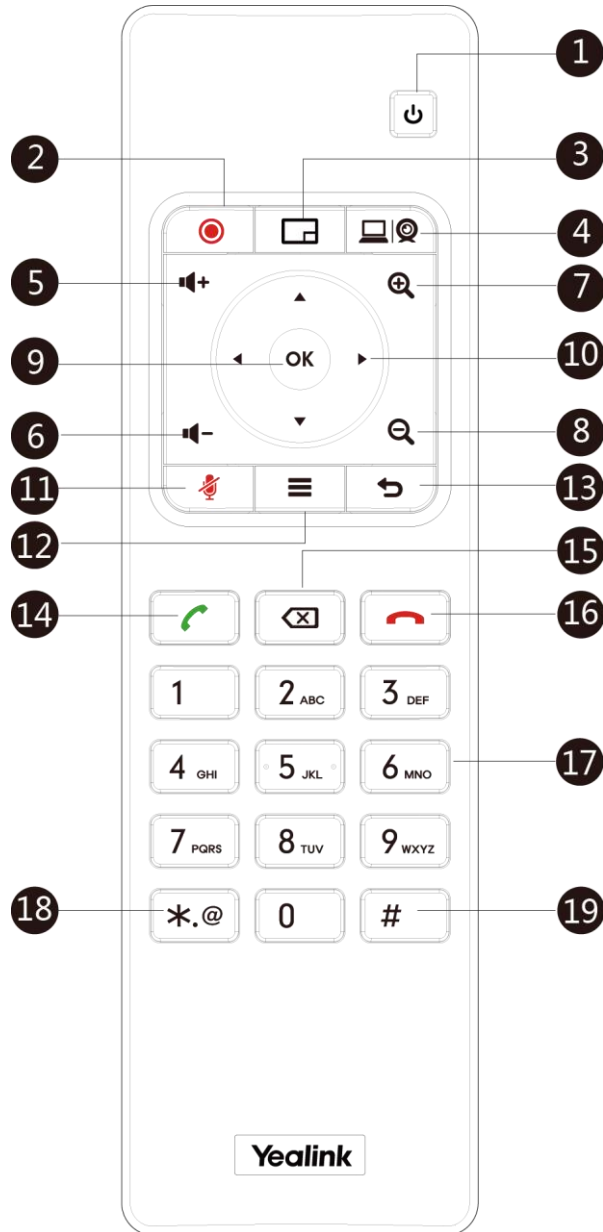

Hardware components of the remote control:

	Item	Description
①	Power Key	<ul style="list-style-type: none"> Power the System On and Off. Puts the system to sleep or wakes the system.
②	Video Recording Key	Starts or stops recording video and audio.
③	Layout Key	Adjust layout during a video call.















	Item	Description
④	Custom Key	Assign predefined functions to this key. This key can be configured as Input key (default), ScreenShot key, Mute Speaker and Presentation key. For more information, refer to Custom Key Type on page 61.
⑤	Vol+	Increases the system volume.
⑥	Vol-	Decreases the system volume.
⑦	Zoom in Key	<ul style="list-style-type: none"> Increases the camera zoom. Increases the captured image magnifications. Behaves as page up in a multiple page list.
⑧	Zoom out Key	<ul style="list-style-type: none"> Decreases the camera zoom. Decreases the captured image magnifications. Behaves as page down in a multiple page list.
⑨	OK Key	Confirms actions or answers incoming calls.
⑩	Navigation Key	<ul style="list-style-type: none"> Navigate through menu items using the Up, Down, Left, and Right keys. Pan and tilt the camera to adjust the viewing angle.
⑪	Mute Key	Toggles the mute feature.
⑫	Home Key	<ul style="list-style-type: none"> Returns to the idle screen when in the menu. Opens Talk Menu during a call.
⑬	Back Key	Returns to the previous menu.
⑭	Off-hook Key	<ul style="list-style-type: none"> Enters the pre-dialing screen. Places a call. Answers a call.
⑮	Delete key	<ul style="list-style-type: none"> Deletes one character at a time. Long press to delete all characters in the input field. Long press it for 2 seconds to start capturing packets and long press it for 2 seconds again to stop capturing packets.
⑯	On-hook Key	<ul style="list-style-type: none"> Ends a call or exits from a conference call. Returns to the idle screen.
⑰	Keypad	<ul style="list-style-type: none"> Enters digits. Enters the pre-dialing screen.
⑱	Character Key	Generates special characters: .@*.



















	Item	Description
①9	# Key	Generates a pound key (#).

Icon Instructions

Icons on Display Device

















Icons appearing on the display device are described in the following table:

Icons	Descriptions
	Network is available
	CP960 conference phone is not connected
	SIP account is registered
	H.323 account is registered
	Log into the Yealink VC Cloud Management Service/Yealink Meeting Server
	Log into the StarLeaf/Zoom/Pexip/BlueJeans/Mind platform
	VCH50 video conferencing hub is connected to the VC800 codec
	Auto answer
	Missed calls (this icon displays on the status bar)
	Output volume is 0
	Do not disturb
	Dual-screen mode
	Dual video sources (when a PC is connected)
	A USB flash drive is inserted
	VPN is enabled

Icons	Descriptions
	Call mute
	Call encryption
	Call is held
	Output volume is 0 during a call
	Camera that being controlled
	Indicates the content displayed on the second display device
	Records video and audio
	Dialed calls (H.323 account/SIP account/IP Call)
	Dialed calls (Cloud platform)
	Received calls (H.323 account/SIP account/IP Call)
	Received calls (Cloud platform)
	Missed calls (H.323 account/SIP account/IP Call)
	Missed calls (Cloud platform)
	Local contact
	Conference contact
	Yealink Cloud contact or YMS contact
	Places video calls
	Places voice calls

Icons on CP960 Conference phone

Icons appearing on the CP960's touch screen are described in the following table:

Icons	Descriptions
	Auto answer
	Missed calls (this icon displays on the status bar)
	Do not disturb
	The number of connected CPW90 wireless expansion microphones
	Call mute
	Call encryption
	Output volume is 0
	Local contact
	Conference contact
	Yealink Cloud contact or YMS contact
	Dialed calls (H.323 account/SIP account/IP Call)
	Dialed calls (Cloud platform)
	Received calls (H.323 account/SIP account/IP Call)
	Received calls (Cloud platform)
	Missed calls (H.323 account/SIP account/IP Call)
	Missed calls (Cloud platform)

LED Instructions

Indicator LED on the VC800 codec:

LED Status	Description
Solid green	The VC800 codec is powered on.
	The VC800 codec is upgrading firmware.
Solid red	The VC800 codec is in sleep mode.
Solid orange	System exception (e.g., network unavailable, update failure).
Off	The VC800 codec is powered off, or is not connected to the power adapter.

Mute key LED on the CP960:

LED Status	Description
Solid red	The CP960 conference phone is initializing.
	The CP960 conference phone is muted.
Flashing red	The CP960 conference phone is ringing.
Solid green	The CP960 conference phone is placing a call.
	The CP960 conference phone is in a call and unmuted.
Off	The CP960 conference phone is idle.
	The CP960 conference phone is not connected to the VC800 correctly.

Mute Indicator LED on the CPE90 Wired Expansion Mic:

LED Status	Description
Solid red	The CP960 conference phone is muted.
Flashing red	The CP960 conference phone is ringing.
Solid green	The CP960 conference phone is placing a call.
	The CP960 conference phone is in a call and unmuted.
Off	The CPE90 is not connected to the CP960 conference phone.
	The CPE90 is idle.

User Interfaces

There are two ways to customize the configurations of your VC800 video conferencing system:

- [Web User Interface](#)
- [Remote Control](#)

Note

The display device and remote control constitute the system user interface. This allows the user to execute all call operation tasks and basic configuration changes directly. Detailed operational steps will be explained in the feature section.

Web User Interface

You can customize your system via web user interface. To access the web user interface, you need to know the IP address of your new system.

To obtain the IP address, do one of the following:

- The IP address of the system is shown on the top right corner of the display device.
- Select  (**More** menu), and then select **Status ->Network**.

The display device shows network information about the system.

- Tap  ->**Network** on the CP960 conference phone.

The touch screen of the CP960 conference phone displays the network information.

Log into the web user interface:

1. Enter the IP address (e.g., `http://192.168.0.10` or `192.168.0.10`) in the address bar of a web browser on your PC, and then press the **Enter** key.
2. Enter the administrator user name and password.

The default user name is "admin" (case-sensitive), and the default password is "0000".

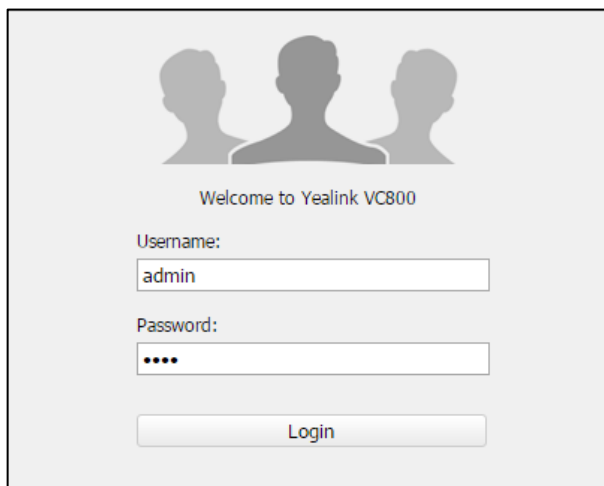

Welcome to Yealink VC800

Username:

Password:

3. Click **Login**.

After you log into the web user interface successfully, you can click **Logout** on the top right corner of the web interface to log out.

Remote Control

You can use the remote control to configure and use the VC800 video conferencing system. For more information on the function of each key on the remote control, refer to [VCR11 Remote Control](#) on page 13.

The **Advanced** option is only accessible to the administrator. The default administrator password is "0000". For more information on how to view, enter and edit the menu settings on the display device, refer to [Navigating Menus and Fields](#) on page 32 and [Entering Data and Editing Fields](#) on page 35.

Virtual Remote Control

In addition to using the remote control, you can also control the VC800 video conferencing system via virtual remote control.

To control VC800 video conferencing system via the virtual remote control:

1. Click **Home->Remote Control** when the system is idle or during a call.

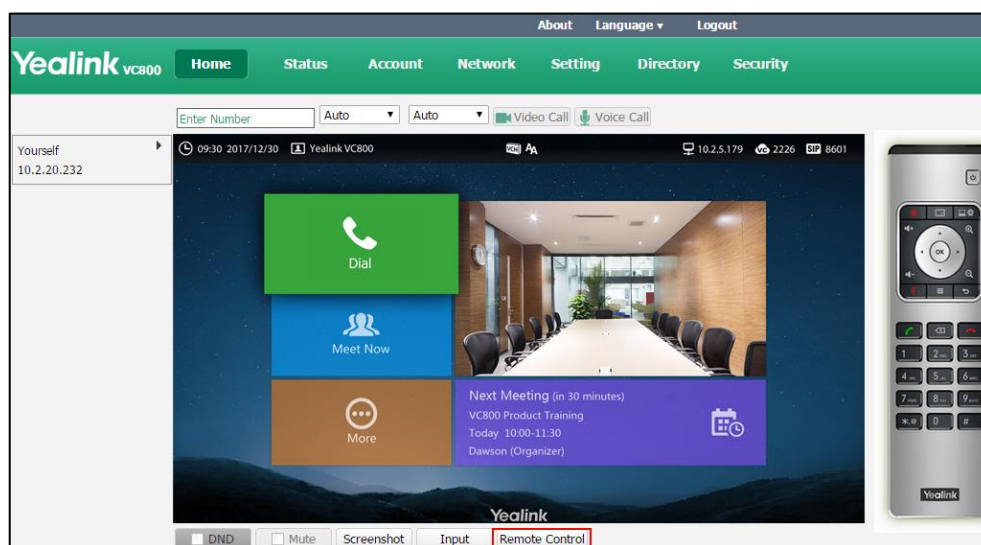

2. Click the keys on the virtual remote control to control the VC800 video conferencing system.

3. Click **Remote Control** to hide the virtual remote control.

Getting Started

This chapter provides the following basic installation instructions and information for achieving the best performance from your VC800 video conferencing system. Topics include:

- [Connecting the VC800 Video Conferencing System](#)
- [Installing the VC800 Video Conferencing System](#)
- [Installing Batteries for the Remote Control](#)
- [Powering the System On](#)
- [Put the System to Sleep](#)
- [Powering the System Off](#)
- [Setup Wizard](#)
- [Controlling Local Camera](#)
- [Registration](#)
- [Idle Screen](#)
- [Navigating Menus and Fields](#)
- [Entering Data and Editing Fields](#)
- [System Status](#)

If you require additional information, or assistance to help you use your new phone, contact your system administrator.

Connecting the VC800 Video Conferencing System

This section introduces the following:

- [Connecting the VC800 codec](#)
- [Connecting the Audio Device](#)

Note

Up to two display devices can be connected to the VC800 codec. Because the display device is not included in the package, you need to purchase it separately if required. Ensure that the purchased display device supports HDMI input.

When connecting only one display device to the VC800 codec, display1 port is the only available port. If dual screen mode is required, you can connect secondary display device to the Display2 port.

To prevent shock, do not connect the power adapter and turn on the power before connecting all system components.

Connecting the VC800 Codec

1. Connect the **LAN** port on the VC800 codec to a switch/hub device port with the supplied 3m network cable.
2. Locate the **HDMI** port on the VC800 codec, and connect it to the **HDMI** port on the display device with the supplied HDMI cable (Make sure the display device is powered on).
3. Locate the **VC Hub/Phone** port on the VC800 codec, and connect it to the **Codec** port on the VCH50 video conferencing hub using 7.5m network cable.
4. Do one of the following to share contents:
 - Locate the **HDMI** port on the VCH50 video conferencing hub, and connect it to the **HDMI** port on the PC with the supplied HDMI cable. So that you can share contents during a call.
 - Locate the **MINI DP** port on the VCH50 video conferencing hub, and connect it to the **MINI DP** port on the PC with the supplied mini DP cable. So that you can share contents during a call.
5. Locate the **Audio** port on the VCH50 video conferencing hub, and connect it to the **Internet** port on the CP960 conference phone.

- Connect the DC48V port on the VC800 codec to an AC power outlet with the supplied power adapter and power cord.

Note

The VC800 video conferencing system should be used with Yealink original power adapter (48V/0.7A) only. The use of the third-party power adapter may cause the damage to the system. The cable and wire should be replaced at once if its skin is broken.

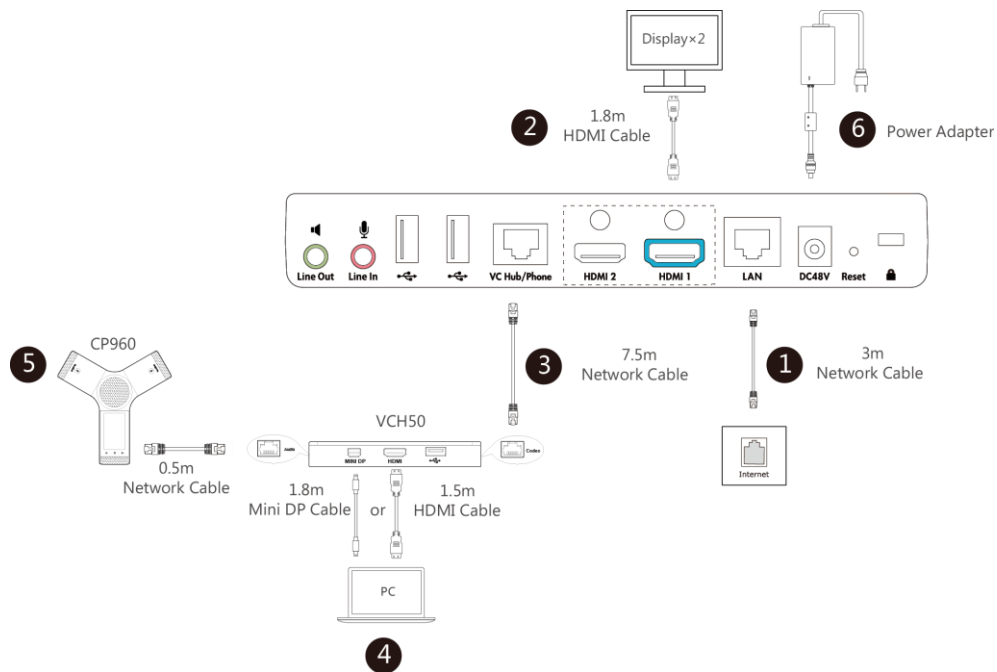
**Note**

If you do not need presentation, you can locate the **VC Hub/Phone** port on the VC800 codec, and connect it to the **Internet** port on the CP960 conference phone using a 7.5m network cable directly.

Connecting the Audio Device

If your video conferencing room is large, you can add extra expansion microphones to the CP960 conference phone to expand the audio range.

For more information on connecting CPW90 to the CP960 conference phone, refer to [Registering CPW90 with the CP960 Conference Phone](#) on page 175.

To connect the CPE90 wired expansion mic to the CP960 conference phone:

1. Connect the free end of the CPE90 cable to the MIC ports on the CP960 conference phone.

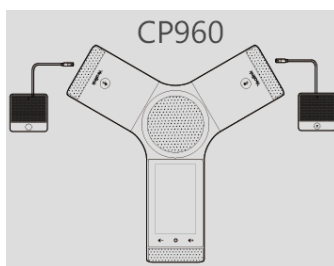

You can fasten all cables with cable ties after all devices are connected.



Installing the VC800 Video Conferencing System

You can choose to mount the VC800 codec on your TV or a wall, depending on your actual needs.

Mounting the VC800 Codec on a TV

When the thickness of your TV is between 35-120 mm, you can mount the VC800 codec on your TV.

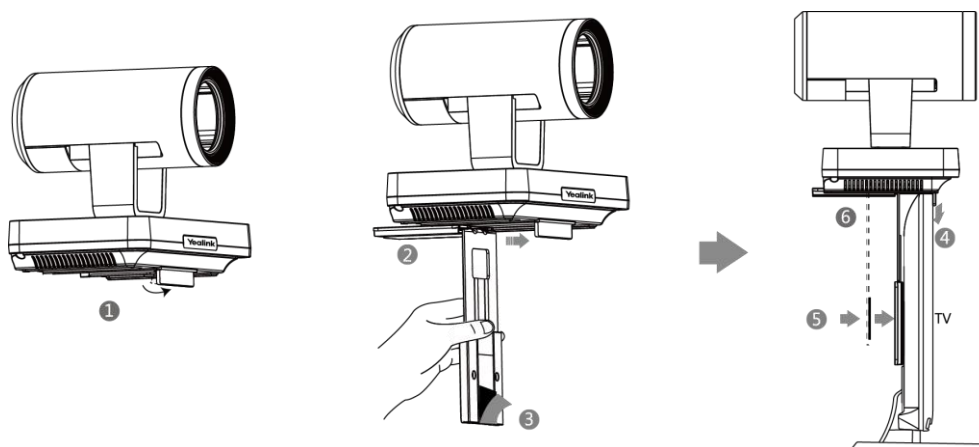

Do the following:

1. Open the baffle.
2. Push the bracket along the track.
3. Remove the protection of the Velcro.
4. Put the L-bracket on the top of the TV.
5. Make sure the back of the TV is clean, and then adjust the bracket to ensure close adhesion to the back of the TV with Velcro.
6. Lock the VC800 codec to the L-bracket with the M3×8 screws.

Mounting the VC800 Codec on a Wall

You can also decide to mount the VC800 codec on a wall. The recommended height for VC800 codec positioning is 1.5m-1.8m above the ground.

Do the following:

1. Punch holes into the wall and then insert the expansion bolts.
Installation location for the expansion bolts and punching requirement are shown above.
2. Drive screws.

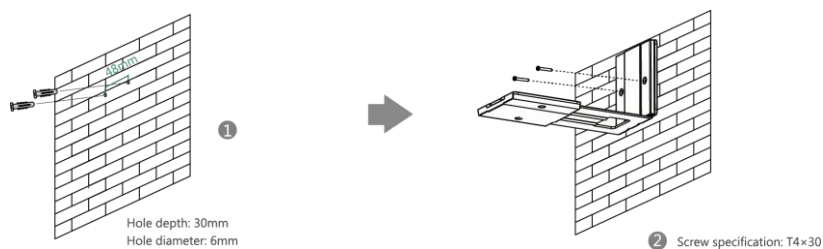

3. Push the VC800 codec along the track of the bracket.

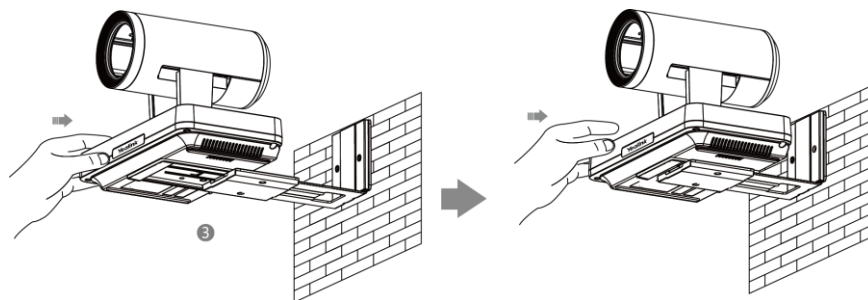

4. Lock the VC800 codec to the L-bracket with the M3×8 screws.

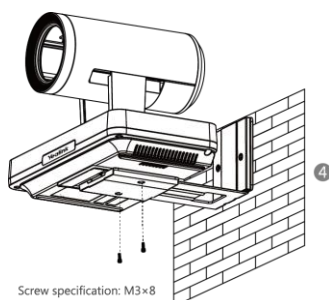

Installing Batteries for the Remote Control

Do the following:

1. Open the battery cover on the back of the remote control.
2. Insert the batteries with correct polarity.
3. Replace the battery cover.

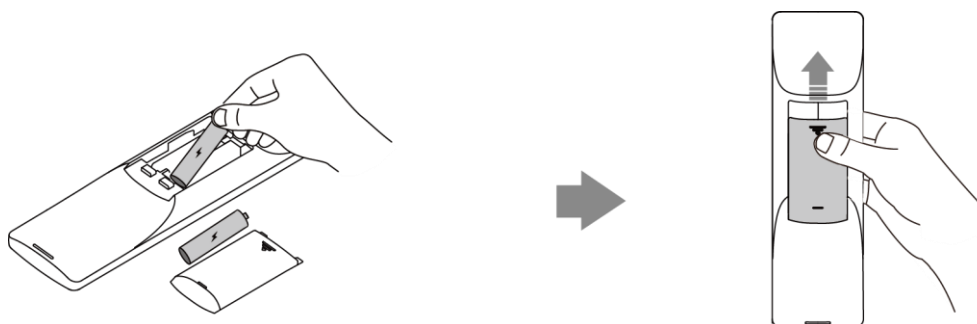

Remote Control Battery Safety Information

- Never make wrong polarity connection when charging and discharging battery packs.
- Avoid crushing, puncturing, or putting a high degree of pressure on any battery, as this can cause an internal short-circuit, resulting in overheating.
- Remove the batteries if they are not in use for long period of time. Battery leakage and corrosion can damage the remote control, dispose batteries safely.
- Do not dispose used batteries in domestic waste. Dispose batteries at special collection points or return to stores if applies.
- Do not dispose batteries in a fire.

Powering the System On

To power on the system:

1. Locate the DC48V port on the VC800 codec, and connect it to the electrical power outlet





with the supplied power adapter.

The VC800 video conferencing system starts up automatically, and the indicator LED on the VC800 codec then illuminates solid green.

Put the System to Sleep

After a certain amount of time with no activity, the VC800 video conferencing system goes into sleep mode automatically.

Put the system to sleep via the remote control:

1. Press .
2. Press  or  to scroll to **Sleep** and then press .

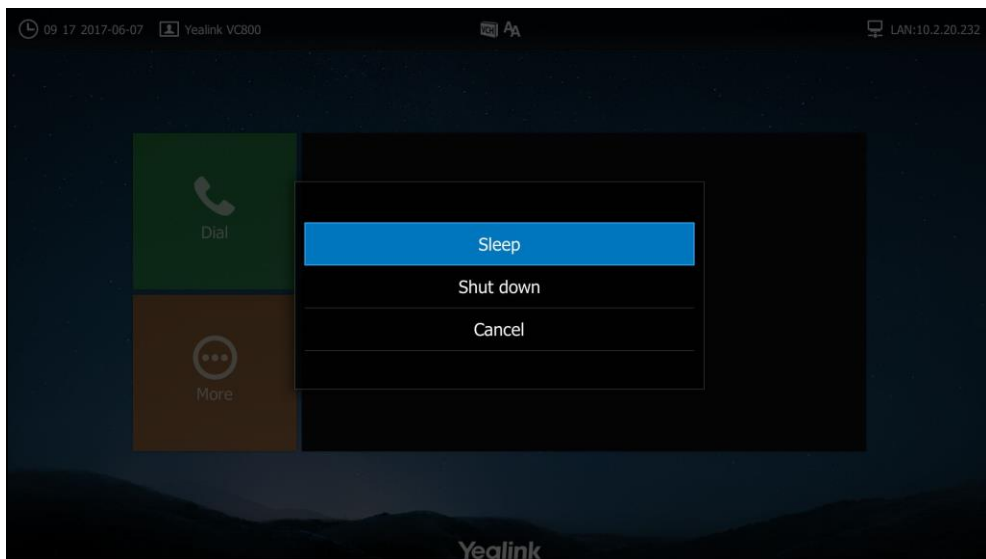

The system goes to sleep immediately. The indicator LED on the VC800 codec illuminates solid red.

Wake the system via the remote control:





1. Press any button on the remote control.
The indicator LED on the VC800 codec illuminates solid green.

Wake the system via the CP960 conference phone:

1. Tap the touch screen or any key.
The indicator LED on the VC800 codec illuminates solid green.

Powering the System Off

To power off the system via the remote control:

1. Press .
2. Press  or  to scroll to **Shut down** and then press .

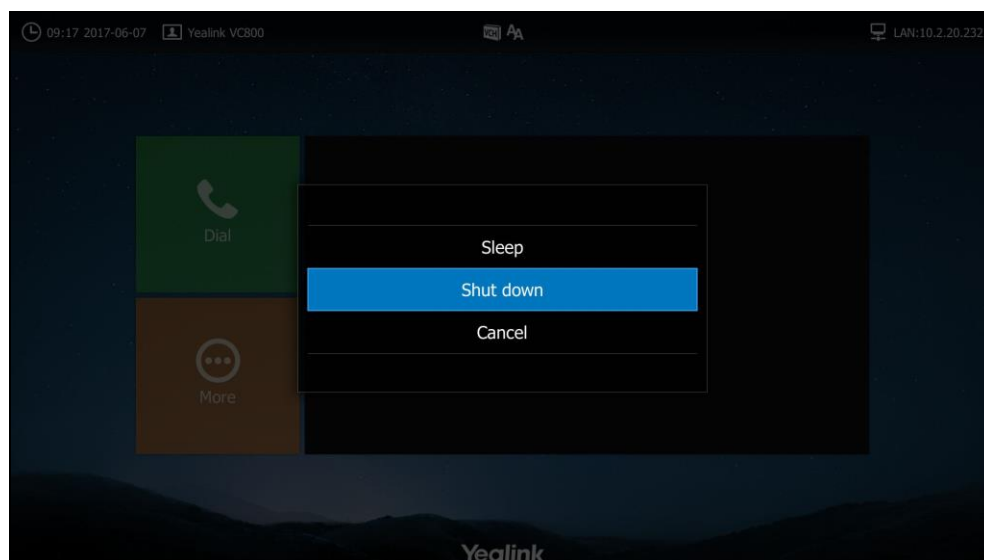

The system shuts down immediately. The indicator LED on the VC800 codec is off.

To power on the system again via the remote control:

1. Press .
- The indicator LED on the VC800 codec illuminates solid green.

Setup Wizard

When you first start up or reset the system, the display device will display the setup wizard.

To complete the setup wizard via the remote control:

1. Set the language displayed on the display device.
The default language is English.
2. Set the date and time (e.g., set the time zone, time format, date format and the type of the daylight saving time).
The system obtains the time and date from the NTP server automatically by default. You can also configure the time and date manually. For more information, refer to on [Time & Date](#) on page 50.
3. Edit the site name.
The default site name is "Yealink VC800".
4. Change the administrator password.

The default administrator password is "0000". For security reasons, the administrator should change the default administrator password as soon as possible.

Note

Do remember the new administrator password or keep a copy of the password in a safe place. If you forget the password, you will need to reset the system to the factory settings, and then reset the password or use the default password "0000".

5. The display device displays firewall port mapping information.

6. Configure network settings.

The phone will try to contact a DHCP server in your network to obtain network parameters by default. If you uncheck the DHCP checkbox, you will need to configure IPv4 or IPv6 network manually.

7. (Optional) Log into the Cloud platform.

Yealink video conferencing system supports Yealink VC Cloud Management Service/Yealink Meeting Server/StarLeaf/Zoom /Pexip/BlueJeans/Mind/Custom platform. For more information, refer to [Yealink VC800 Full HD Video Conferencing System Administrator Guide](#).

8. Select **Complete Setup** and press  to complete the setup wizard.



Note

You can tap **Exit Boot Wizard** on the CP960 to skip the setup wizard.

Controlling Local Camera

Before placing a video call, you need to be familiar with how to adjust the angle and focus of the camera. Avoid physically adjusting the camera to prevent damaging it. Always use the remote control to control the camera.

To control local camera via the remote control:

1. Select local camera.
2. Press the navigation key to adjust the angle of the camera.
3. Press  or  to adjust the focus of the camera.

Registration

You can register the H.323 account, SIP account and log into Cloud platform (Yealink VC Cloud Management Service/Yealink Meeting Server/StarLeaf/Zoom/Pexip/BlueJeans/Mind/Custom platform). Generally, your system administrator will configure the account beforehand, so that after you start up the system, the system will already be registered and ready for use. If your system is not registered, you may have to register it. For more information on how to register an account for the system, refer to [Yealink VC800 Full HD Video Conferencing System Administrator Guide](#).

Idle Screen



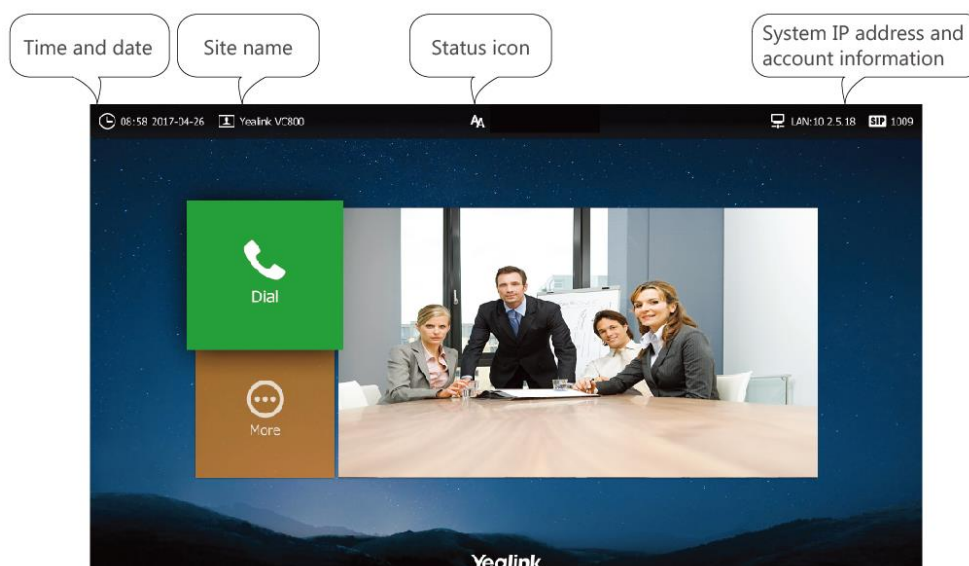

Idle Screen of VC800 Video Conferencing System

Idle screen of the display device

If the system starts up, the idle screen will be shown. The following figure is an example:



Name	Description
Time and Date	The time and date are displayed on the left of the status bar.
Site name	The site name of the system. For more information on how to change the site name, refer to Site Name on page 48.
Status icon	Status icons are displayed in the center of the status bar. For more information on the status icon, refer to Icons on Display Device on page 15.
IP address	<ul style="list-style-type: none"> • LAN: X.X.X.X: Indicates the system has obtained an IP address. • Network disconnected: Indicates the system does not connect to a network cable. Please check the network cable. • 255.255.255.255: Indicates the system fails to obtain an IP address. Check the connection between the system and the DHCP server, or you can configure a static IP address for the system. For more information on how to

Name	Description
	configure a static IP address, refer to Setup Wizard on page 28.
Registered account	When the VC800 system is registered with the SIP server, the account icon is  . For more information, refer to Yealink VC800 Full HD Video Conferencing System Administrator Guide .
	When the VC800 system is registered with an H.323 gatekeeper, the account icon is  . For more information, refer to Yealink VC800 Full HD Video Conferencing System Administrator Guide .
	When the VC800 system logs into Yealink VC Cloud Management Service/Yealink Meeting Server, the icon is  . When the VC800 system logs into a StarLeaf/Zoom/Pexip/BlueJeans/Mind platform, the icon is  . For more information, refer to Yealink VC800 Full HD Video Conferencing System Administrator Guide .
Dial	Enter the pre-dialing screen.
More	Configure the video conferencing system.
Video image	Display local video image or local PC content.

Idle Screen of CP960 Conference phone



NO.	Name	Description
1	Status Bar	Displays the icons and time.

NO.	Name	Description
2	Digital Clock Widget	Displays the phone's time and date.
3	Scheduled conference information	When you register a YMS account, this field will display the scheduled conference details. For more information, refer to Scheduled Conference on page 142.
4	Applications	Use the corresponding features.
5	Screen Indicator	Indicates which idle screen is displayed. You can swipe left or right to switch among different screens.













Navigating Menus and Fields

Navigating the Display Device

You can use the remote control to enter the main menu screen, and view the items on the display device.

Note The system will automatically return to the idle screen after 60 seconds of inactivity.

To navigate menus and fields, you can:

If you want to	You can
Return to the idle screen.	Press  or  .
Go back to the previous menu.	Press  .
Navigate through menus.	Press  or  to select a menu. Press  or  to select an item.
Expand pull-down list.	Press  or  to expand a pull-down list.
Select an option from the pull-down list.	From the pull-down list, Press  or  to scroll to the setting and then press  .
Enable or disable features.	Press  .

Navigating the CP960 Conference phone

The following sections introduce how to navigate CP960 Conference phone. Topics include:

- [Navigating Touch Screen](#)

- [Gestures](#)
- [Control Center/Notification Center](#)





Navigating Touch Screen

To operate your phone, follow these tips:

If you want to	Action
Return to the idle screen.	Tap Home key on the CP960 conference phone.
Go back to the previous menu.	Tap  .
Select an item.	Tap the item.
Scroll through items page by page.	Drag up and down to scroll. (You can wait for the scrolling to come to a stop, or touch the screen to stop it immediately.)
Scroll through values for a field.	Drag up and down to scroll through values.
Select a value for a field.	Tap the value or scroll to the value in the pop-up dialog box.

Gestures

To operate your phone using gestures, follow these tips:

Gesture		Action
Tap		Touch an item on the screen with your finger, and then lifting your finger. For example: tap  to enter directory.
Swipe		Tap and move. When you want to scroll quickly, swipe your finger across the screen, either up, down, left or right.
Drag		Touch and hold, then move. To stop scrolling, stop the dragging motion.

Control Center/Notification Center

Control center or notification center allows you to access to common features or view important notifications quickly.

Swipe down from the top of the screen to enter the control center and the notification center:



No.	Name	Description	
1	Time and date	Display the phone's time and date. For more information, refer to Time & Date on page 50.	
2		<ul style="list-style-type: none"> Indicate the number of connected CPW90 Wireless Expansion Mic. Tap to enter the wireless microphone settings screen. For more information, refer to Registering CPW90 with the CP960 Conference Phone on page 175. 	
3	Control Center	Backlight Slider	Drag the slider to adjust the screen brightness quickly. You can also enter the Backlight setting screen to adjust the screen brightness. For more information, refer to Backlight on page 46.
		Mute	Tap to mute or unmute.
		DND	Tap to turn DND on or off quickly. For more information, refer to Do Not Disturb (DND) on page 112.
		Auto Answer	Tap to turn auto answer on or off quickly. For more information, refer to Auto Answer on page 110.
		Silent	Tap to turn silent mode on or off quickly. For more information, refer to Volume Settings on page 56.

No.	Name	Description
4	Notification Center	<ul style="list-style-type: none"> Tap the desired notification message to view the details. Swipe left or right to delete a specific notification. Tap Clear to delete all notifications.

Entering Data and Editing Fields

Entering Data and Editing Fields Using Remote Control



VC800 video conferencing system provides onscreen keyboard and dial pad on the remote control to enter data. Dial pad on the remote control provides standard key layout, which enable users to use existing or familiar key positions. You can enter data and edit fields using the onscreen keyboard or dial pad on the remote control.

Using the Onscreen Keyboard

Before using the onscreen keyboard, you need to know the function of the keys on the onscreen keyboard. VC800 video conferencing system supports two kinds of input methods: English and Russian. For more information, refer to [Keyboard Input Method](#) on page 36.

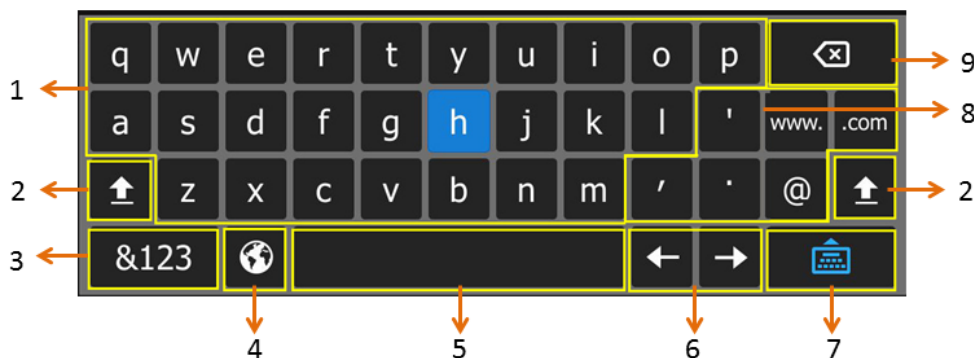
The following takes English input method as an example:



No.	Item	Description
1	26 English Letters	Enter characters.
2		Switches to the uppercase input mode
3	&123	Switches to the numeric&symbolic input mode
4		Switches between the Russian or English input mode

No.	Item	Description
5	Space Key	Enter a space.
6	Cursor	Position a cursor
7		Hides the onscreen keyboard
8	Special Characters	Enter the corresponding special character.
9	Delete Key	<ul style="list-style-type: none"> • Press once to delete a entered character. • Long press to delete two or more characters.

Using the Dial Pad

Instead of using the onscreen keyboard, you can also press the dial pad on the remote control to enter data. The dial pad only provides digit keys and #.@* key.

Note

When using the dial pad on the remote control, you can select  to use the onscreen keyboard.



Keyboard Input Method

Onscreen keyboard on the VC800 video conferencing system supports English and Russian keyboard input methods. You can enter and edit characters using the enabled input methods. You can configure keypad input method via web user interface only.

To configure keyboard input method via web user interface:

1. Click on **Setting** -> **General**.
2. In the **Keyboard IME** block, select the desired list from the **Disabled** column and click .

The selected input method appears in the **Enabled** column.
3. Repeat step 2 to add more input methods to the **Enabled** column.
4. (Optional.) To remove a list from the **Enabled** column, select the desired list and then click .

5. To adjust the display order of the enabled input methods, select the desired list, and click  or .

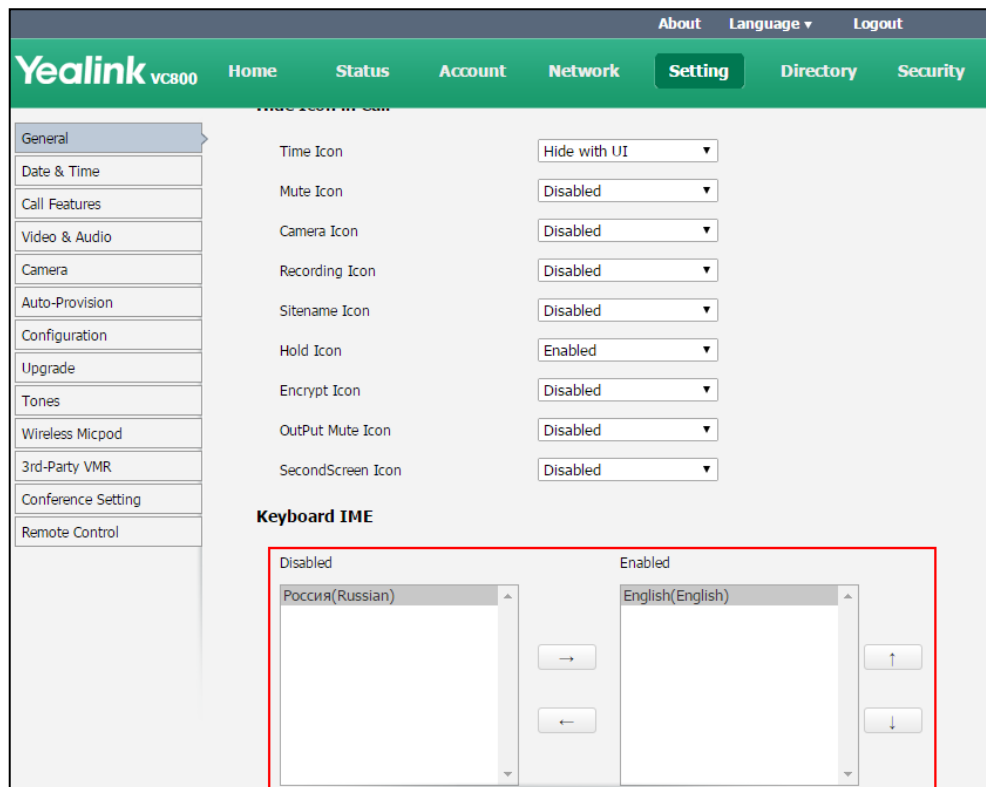

6. Click **Confirm** to accept the change.

Entering Data and Editing Fields Using CP960

CP960 conference phone provides onscreen keyboard and onscreen dial pad to enter data. Onscreen dial pad provides standard key layout, which enable users to use existing or familiar key positions. You can enter data and edit fields using the onscreen keyboard or onscreen dial pad.

Using the Onscreen Keyboard

Before using the onscreen keyboard, you need to know the function of the keys on the onscreen keyboard. CP960 conference phone supports two kinds of input methods: Android Keyboard (AOSP) - English (US) and Google Pinyin.

Android Keyboard (AOSP) – English (US) Input Method

The English (US) input method supports English languages onscreen keyboard. The following shows an example:

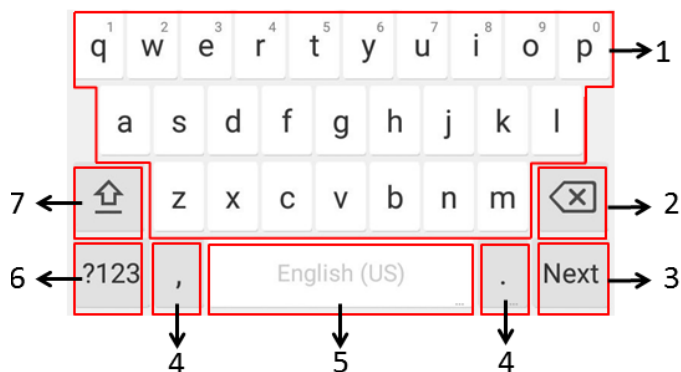

No.	Item	Description	
1	26 English Letters	<ul style="list-style-type: none"> • Tap to enter letters. • Long tap a key then slide to choose one of the options to enter an alternate character. 	
2	Delete Key	<ul style="list-style-type: none"> • Tap to delete the entered characters one by one. • Long tap to delete two or more characters. 	
3	Label automatically to identify the context-sensitive features.	Next Key	Tap to go to the next field.
		Send Key	Tap to dial out the number.
4	Two Special Characters	<ul style="list-style-type: none"> • Tap to enter special characters. • Long tap point key (.) then slide to choose one of the options to enter an alternate character. 	
5	Space Key	<ul style="list-style-type: none"> • Tap to enter spaces. • Long tap to change input method. 	
6	?123	Tap to switch to the numeric&symbolic input mode.	
7	Uppercase Key	Tap to switch to the uppercase input mode.	

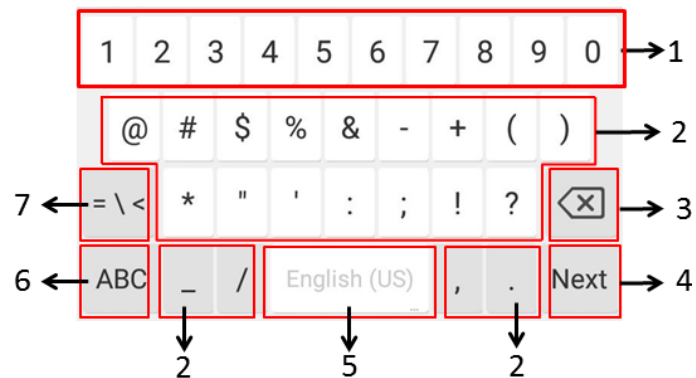

Tap **?123** to switch to the numeric&symbolic input mode as shown below:



No.	Item	Description	
1	Numbers	<ul style="list-style-type: none"> • Tap to enter numbers. • Long tap a key then slide to choose one of the options to enter an alternate character. 	
2	Special Characters	<ul style="list-style-type: none"> • Tap to enter special characters. • Long tap a key then slide to choose one of the options to enter an alternate character. 	
3	Delete Key	<ul style="list-style-type: none"> • Tap to delete the entered characters one by one. • Long tap to delete two or more characters. 	
3	Label automatically to identify the context-sensitive features.	Next Key	Tap to go to the next field.
		Send Key	Tap to dial out the number.
5	Space Key	<ul style="list-style-type: none"> • Tap to enter spaces. • Long tap to change input method. 	
6	ABC	Tap to switch to the lowercase input mode.	
7	= \ <	Tap to switch to the symbolic input mode.	

Tap  to switch to the symbolic input mode as shown below:



No.	Item	Description	
1	Special Characters	<ul style="list-style-type: none"> • Tap to enter special characters. • Long tap a key then slide to choose one of the options to enter an alternate character. 	
2	Delete Key	<ul style="list-style-type: none"> • Tap to delete the entered characters one by one. • Long tap to delete two or more characters. 	
3	Label automatically to identify the context-sensitive features.	Next Key	Tap to go to the next field.
		Send Key	Tap to dial out the number.
4	Space Key	<ul style="list-style-type: none"> • Tap to enter spaces. • Long tap to change input method. 	
5		Tap to switch to the lowercase input mode.	
6		Tap to switch to the numeric&symbolic input mode.	

Google Pinyin Input Method

You can use Google Pinyin input method to enter Chinese. For operating instructions on how to use the Google Pinyin input method, refer to the operating instructions above.



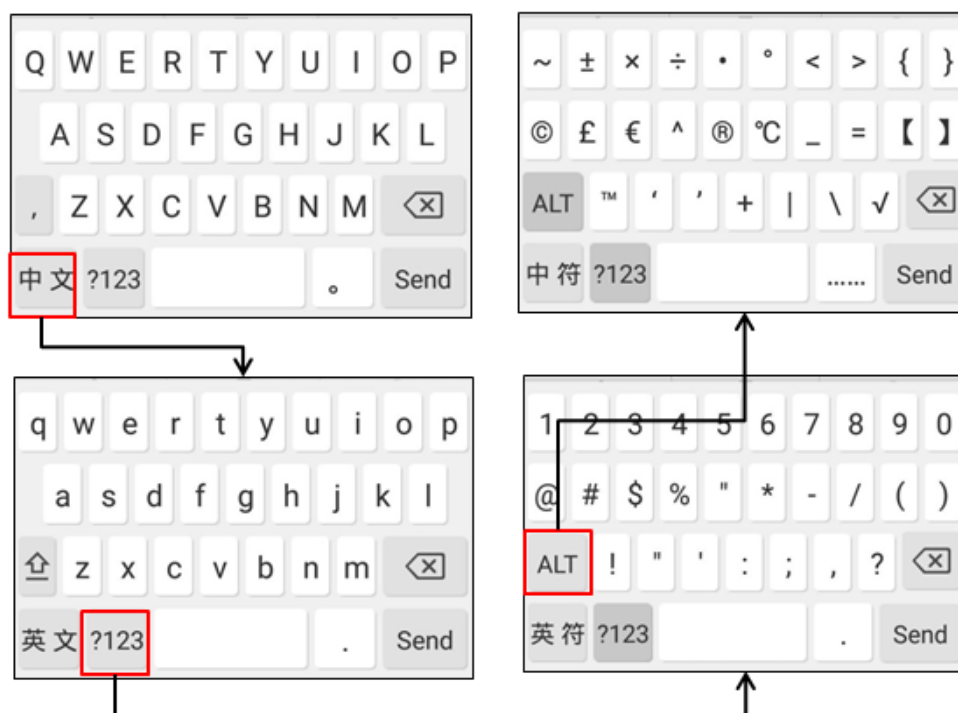

When you change the input method to Google Pinyin, the onscreen keyboard displays the Chinese input mode as shown below by default:





To use onscreen keyboard:

1. Tap the field you want to edit, the onscreen keyboard displays on the touch screen.
2. Enter the information using the onscreen keyboard.
3. Tap **Send** or the non-editable area to hide the onscreen keyboard.

The other things you need to know:

If you want to	Action
Position the cursor.	Tap to position.
Select all characters.	<ol style="list-style-type: none"> 1) Long tap the entered character(s). 2) Do one of the following: <ul style="list-style-type: none"> • Tap  on the top of the touch screen. • Drag  to select all characters.
Cut/Copy characters.	<ol style="list-style-type: none"> 1) Long tap the entered character(s). 2) Drag  to select the characters you want to cut or copy. 3) Tap CUT/POTY or  /  on the top of the touch screen to cut or copy. 4) Long tap the desired field. 5) Tap PASTE.
Delete more characters at a time.	Do one of the following: <ul style="list-style-type: none"> • Long tap the entered character(s).

If you want to	Action
	Drag  to select the characters you want to delete. Tap  . • Long tap  .
Replace characters.	1) Drag your finger to highlight the characters you want to replace. 2) Tap the desired character.

Using the Onscreen Dial Pad

Instead of using the onscreen keyboard, you can also use the dial pad on the dialing screen to enter data. The onscreen dial pad only provides digit keys and **#.@*** key.

Note

When using the onscreen dial pad, you can tap  to display the onscreen keyboard. For more information, refer to [Using the Onscreen Keyboard](#) on page 37.

System Status

When the system is idle, you can view its status via the remote control, CP960 conference phone or web user interface.

Available system status information includes:

- **System information** (device model, firmware, hardware version and product ID)
- **Network status** (LAN type, IP address, MAC, subnet mask, gateway and DNS server, public IP address can be also viewed if the static NAT is enabled)
- **Account status** (register status of SIP account , H.323 account and Cloud platform)
- **Camera** (status, device model, SPEC and hardware version)
- **Audio** (the active microphone and active speaker)
- **VCS Phone** (status, device model, serial number, firmware version, hardware version, IP address and MAC address)
- **Wireless Micpod** (Micpod Version, MICPOD IPEI)
- **License** (multipoint license installation status)

To view the system status via the remote control:

1. Select  (**More** menu).
2. Press  or  to scroll to **Status** and then press  to enter submenu.

3. Press ▲ or ▼ to select the desired list.

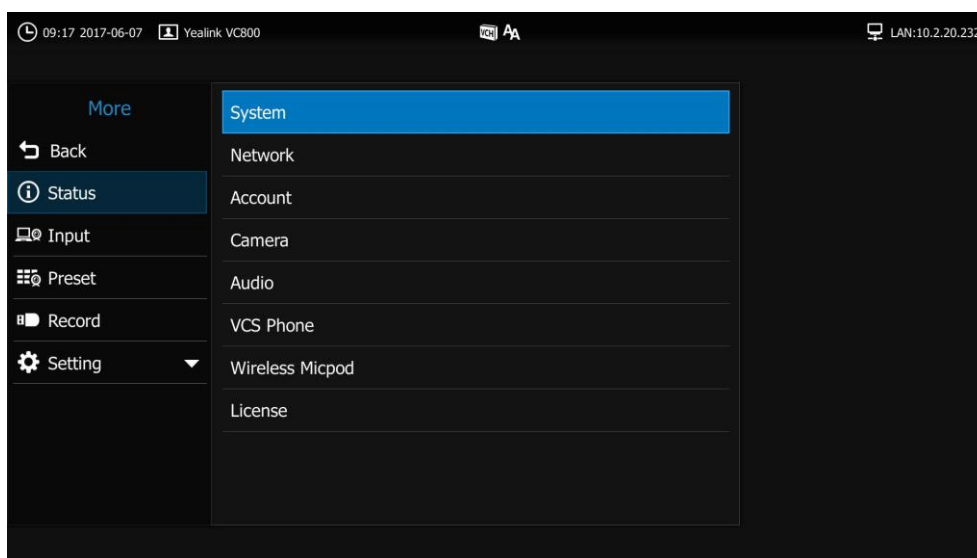

4. Press **OK** to view the specific information.

To view the system status via the CP960 conference phone:

1. Tap  .

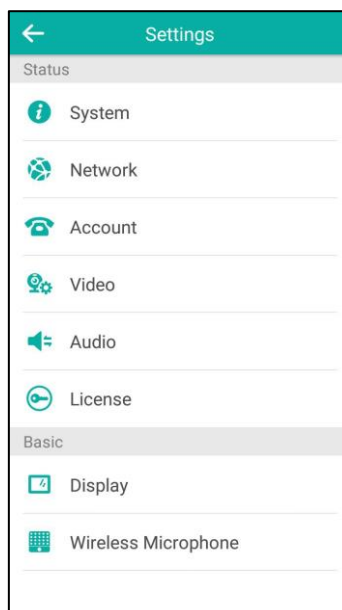

2. Tap the desired list to view the specific information.

To view the system status via web user interface:

1. Click **Status**.

The system status is displayed on the web user interface.

The screenshot shows the Yealink VC800 web user interface. At the top, there is a navigation bar with the following items: About, Language (with a dropdown arrow), and Logout. Below this is a green header bar with the Yealink VC800 logo and a menu containing Home, Status (highlighted), Account, Network, Setting, Directory, and Security. On the left side, there is a sidebar with a 'Status' tab. The main content area displays the system status, organized into two sections: 'System' and 'VCS Phone'. Each section contains a list of attributes and their corresponding values.

System	
System Model	VC800
Firmware Version	63.30.0.6
Hardware Version	63.0.4.0.0.0.0
Product ID	201706191730
Uptime	0 Days 05:06

VCS Phone	
Serial Number	201706191752
Firmware Version	73.80.0.12
Hardware Version	73.0.0.9.0.0.0
Model	SIP-CP960
IP	192.168.0.150
MAC	00-15-65-F2-65-67

Customizing the VC800 Video Conferencing System

You can customize your VC800 video conferencing system by personally configuring certain settings, for example, site name, time & date and language. You can add contacts to the local directory manually or from the call history.

This chapter provides basic operating instructions for customizing your system. Topics include:

- [General Settings](#)
- [Directory](#)
- [Call History Management](#)
- [Call Protocol](#)
- [Bandwidth Settings](#)
- [Audio Setting](#)
- [Far Control Near Camera](#)

If you require additional information or assistance with your new system, contact your system administrator.











General Settings

Automatic Sleep Time

The system will go to sleep automatically when it has been inactive for a period of time (the default period is 10 minutes). When the system is in sleep mode, it can still accept incoming calls. The display device will prompt "No Signal".

You can change the automatic sleep time via the remote control or web user interface.

To configure the automatic sleep time via the remote control:

1. Select  (**More** menu).
2. Press  or  to scroll to **Setting** and then press  to expand the menu.
3. Press  or  to scroll to **Basic** and then press  to enter submenu.
4. Press  or  to scroll to **Automatic Sleep Time** and then press .
5. Select desired time.

If **Always On** is selected, the system will not enter the sleep mode automatically.

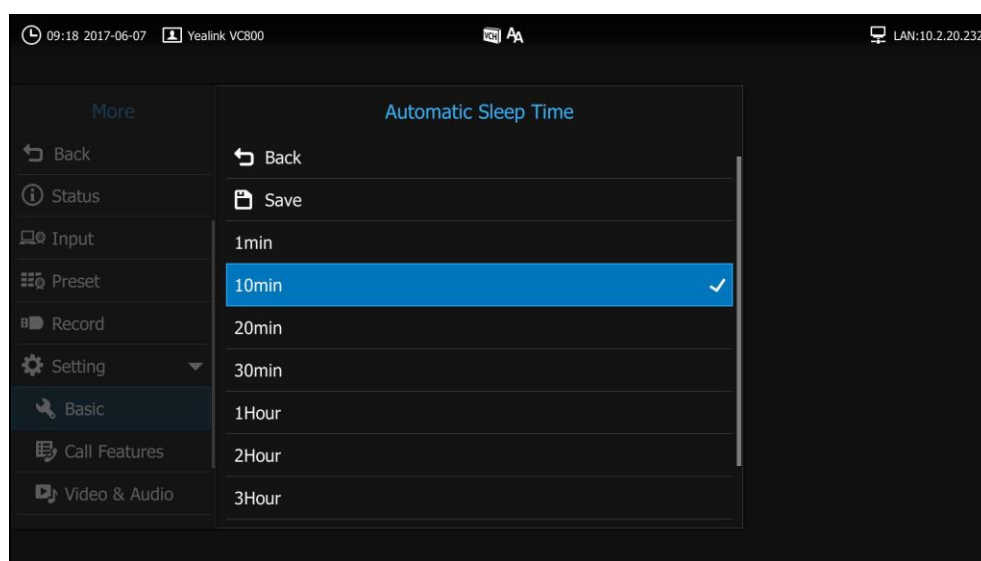

6. Press ▲ or ▼ to select **Save** and then press **OK** to accept the change.

Automatic sleep time is configurable via web user interface at the path

Setting->General->Automatic Sleep Time.

Backlight

The backlight of the CP960 conference phone is always on by default. You can configure backlight time for the CP960's touch screen via the CP960 conference phone or web user interface.

You can configure the touch screen's backlight time in the following formats:



- **Always On:** Backlight is on permanently.
- **15s, 30s, 1 Min, 2 Min, 5 Min, 10 Min, 30 Min:** Backlight goes out when the phone has been inactive for the time you set.

To configure the backlight of the CP960 conference phone:

1. Tap  -> **Display->Backlight.**
2. Drag the **Active Level** slider to change the intensity of the touch screen.
3. Tap the **Backlight Time** field.

4. Tap the desired time in the pop-up dialog box.



5. Tap  to accept the change or  to cancel.

You can also drag the backlight slider on the control center to change the intensity of the touch screen.

To configure the backlight active level via the control center:

1. Swipe down from the top of the screen to enter the control center.

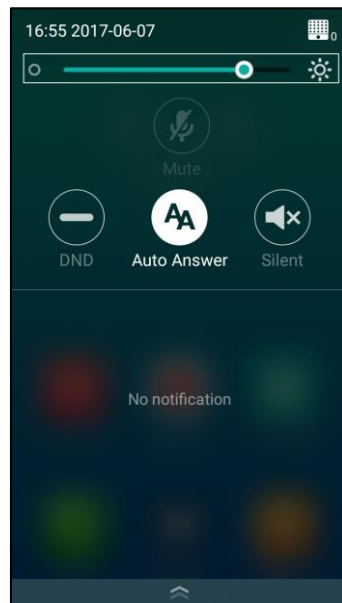

2. Drag the backlight slider.

Backlight is configurable via web user interface at the path **Settings->General->Backlight Time**.

Screen Saver



The screen saver will automatically start each time your phone is idle for a certain amount of time. The screen saver is used to blank the screen or fill it with moving images or patterns.

You can configure screen saver for CP960 conference phone only.

To configure the screen saver via the CP960 conference phone:

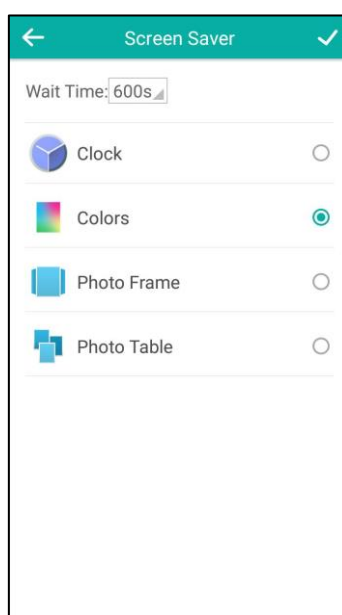
1. Tap  -> **Display**->**Screen Saver**.
2. Tap the **Wait Time** field.
3. Tap the desired time in the pop-up dialog box.
4. Tap the desired screen saver.



5. Tap  to accept the change or  to cancel.

The screen saver will be stopped when:











- Tap any key on the CP960 conference phone.
- Tap the touch screen.
- There is an incoming call.

Site Name



Site name is displayed on the status bar of the display device and CP960 conference phone. You can make an IP address call to the other party, the system site name will be displayed on the remote display device. Site names can consist of letters, numbers or special characters.

Site name is configurable via the remote control or web user interface.

To configure the site name via the remote control:

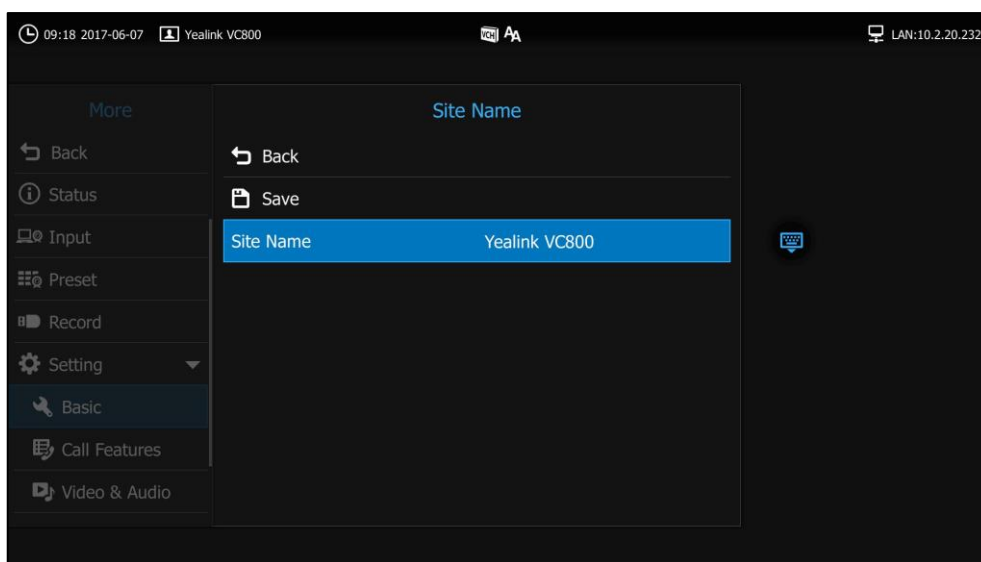
1. Select  (**More** menu).
2. Press  or  to scroll to **Setting** and then press  to expand the menu.
3. Press  or  to scroll to **Basic** and then press  to enter submenu.
4. Press  or  to scroll to **Site Name** and then press .
5. Edit the site name.



6. Press  or  to select **Save** and then press  to accept the change.











Site name is configurable via web user interface at the path **Setting->General->Site Name**.

Language

The default language of the display device is English, and you can change it via the remote control. The CP960 conference phone will detect and use the same language as which of the display device.

The default language of the web user interface is English. You can change the web user interface language for web user interface. The available languages for the system are English, Chinese Simplified, Chinese Traditional, French, German, Italian, Polish, Portuguese, Spanish, Turkish, Russian and Czech.

To change the language for the display device via the remote control:

1. Select  (**More** menu).
2. Press  or  to scroll to **Setting** and then press  to expand the menu.
3. Press  or  to scroll to **Basic** and then press  to enter submenu.
4. Press  or  to scroll to **Language** and then press .

5. Select the desired language and then press **OK**.

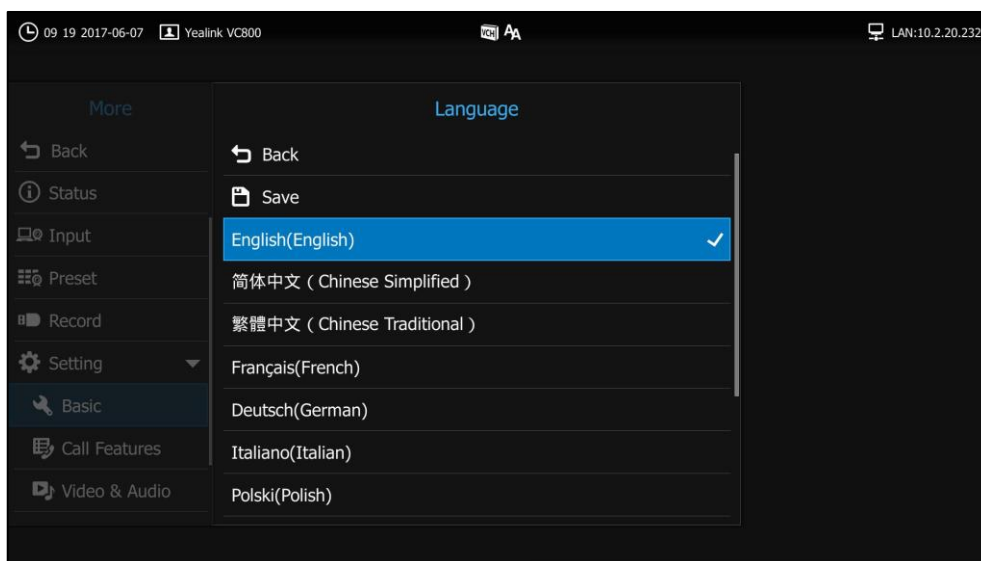

6. Press **▲** or **▼** to select **Save** and then press **OK** to accept the change.
Text displayed on the display device and CP960's touch screen will change to the selected language.

To change the language for the web user interface:

1. Click on **Language** at the top right corner of the web page.
2. Select the desired language from the pull-down list of **Language**.

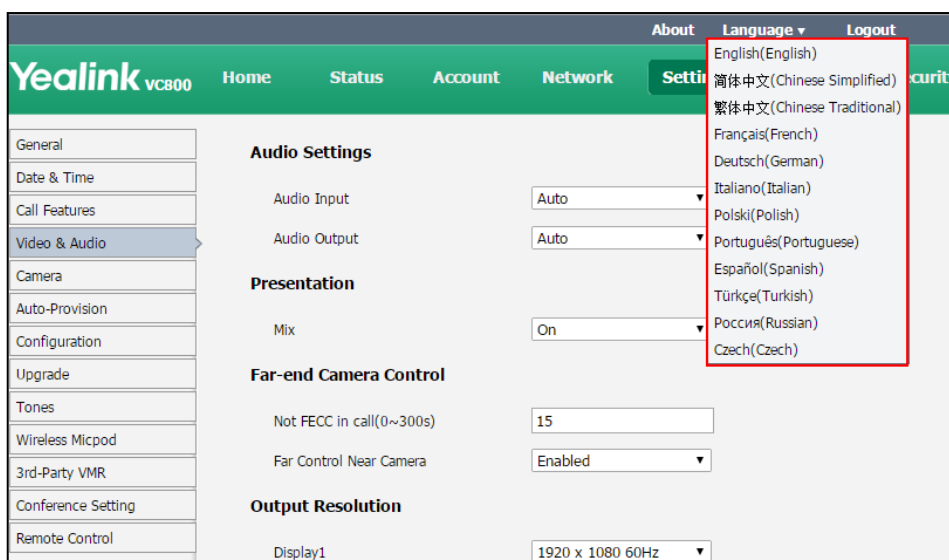

Text displayed on the web user interface will change to the selected language.

Time & Date

Time and date is displayed on the status bar of the display device and CP960 conference phone.

You can configure the system to obtain the time and date from the SNTP (Simple Network Time Protocol) server automatically. The SNTP allows the system to synchronize time to a main server. This keeps all network machine clocks on the same time. Enter the NTP Server name that you want to follow.



If the system cannot obtain the time and date from the SNTP server, you can configure the time and date manually, or contact your system administrator for more information.

There are 7 available date formats. For example, for the date format "WWW DD MMM", "WWW" represents the abbreviation of week. "DD" represents the two-digit day, and "MMM" represents the first three letters of the month.

The available date formats you need to know are:

Date Format	Example (2017-5-23)
WWW MMM DD	Tue May 23
DD-MMM-YY	23-May-17
YYYY-MM-DD	2017-05-23
DD/MM/YYYY	23/05/2017
MM/DD/YY	05/23/17
DD MM YYYY	23 May 2017
WWW DD MMM	Tue 23 May

To configure the NTP server and date & time format via the remote control:

1. Select  (**More** menu).
2. Press ▲ or ▼ to scroll to **Setting** and then press  to expand the menu.
3. Press ▲ or ▼ to scroll to **Basic** and then press ► to enter submenu.
4. Press ▲ or ▼ to scroll to **Date & Time** and then press .
5. Select the desired time format from the pull-down list of **Time Format**.
6. Select the desired date format from the pull-down list of **Date Format**.
7. Select **SNTP Settings** from the pull-down list of **Time Type**.
8. Select the time zone that applies to your area from the pull-down list of **Time Zone**.
9. The default time zone is "+8 China(Beijing)".
10. Enter the domain names or IP addresses in the **NTP Primary Server** and **NTP Secondary Server** fields respectively.
11. Select the desired value from the pull-down list of **Daylight Saving Time**.

When **Automatic** is selected, the system will use daylight saving time corresponding to the selected time zone.

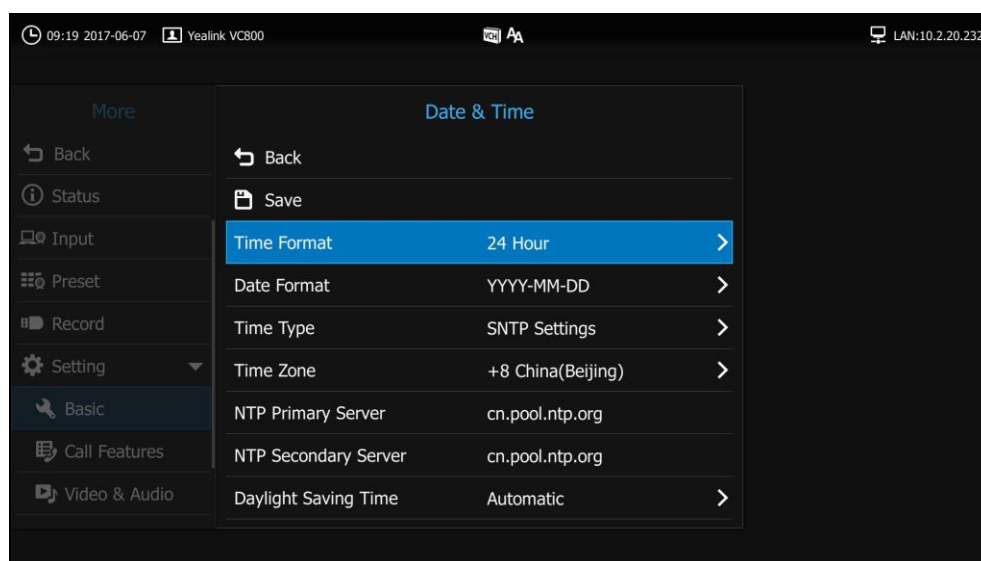

- Press ▲ or ▼ to select **Save** and then press **OK** to accept the change.

Note Please refer to [Appendix A - Time Zones](#) for the list of available time zones on the system.

To configure the time and date manually via the remote control:

- Select **More** (More menu).
- Press ▲ or ▼ to scroll to **Setting** and then press **OK** to expand the menu.
- Press ▲ or ▼ to scroll to **Basic** and then press **▶** to enter submenu.
- Press ▲ or ▼ to scroll to **Date & Time** and then press **OK**.
- Select the desired time format from the pull-down list of **Time**.
- Select the desired date format from the pull-down list of **Date**.
- Select the **Manual Settings** from the pull-down list of **Time Type**.
- Select the desired year from the pull-down list of **Year**.
- Select the desired month from the pull-down list of **Month**.
- Select the desired day from the pull-down list of **Day**.
- Select the desired hour from the pull-down list of **Hour**.
- Select the desired minute from the pull-down list of **Minute**.

13. Select the desired secondary from the pull-down list of **Secondary**.

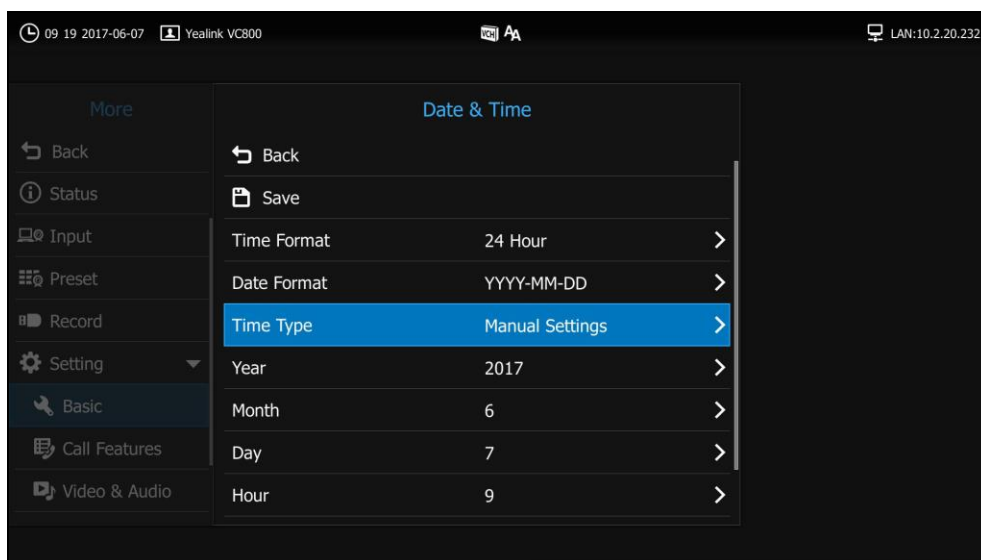

14. Press ▲ or ▼ to select **Save** and then press **OK** to accept the change.

To view current time in different cities via the CP960 conference phone:

1. Tap the digital clock.

The touch screen displays current time in different cities.

2. Tap .

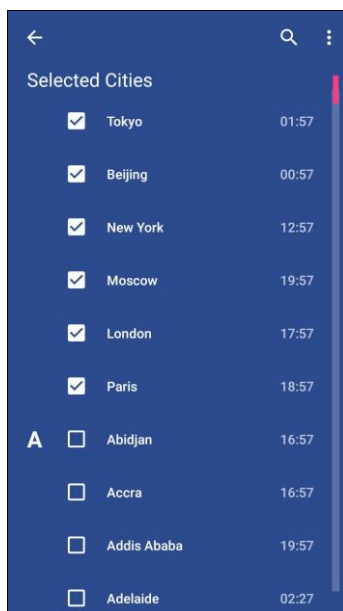



3. Do one of the following:

- Tap  to search the city.

Enter a few or whole characters of the city in the Search field.

Cities match the characters entered will appear on the touch screen.

- Tap  to sort the city.
 - Tap **Sort by name**, unselected cities will be sorted by name.
 - Tap **Sort by time**, unselected cities will be sorted by time.
- 4. Tap the desired city to select or deselect.
- 5. Tap  to return.
- 6. You can see current time of the selected cities.

Time and date is configurable via web user interface at the path **Setting->Date&Time**.

Key Tone











You can enable the key tone feature to play a key tone when you press any key on the remote control.

Key tone is configurable via the remote control or web user interface. Key tone feature is enabled by default.

Note

If ringer volume is adjusted to 0, you cannot hear the key tone. For more information on how to adjust the ringer volume, refer to [Volume Settings](#) on page 56.

To configure the key tone via the remote control:

1. Select  (**More** menu).
2. Press  or  to scroll to **Setting** and then press  to expand the menu.
3. Press  or  to scroll to **Basic** and then press  to enter submenu.
4. Press  or  to scroll to **Key Tone**, and then press  to enable or disable this feature.

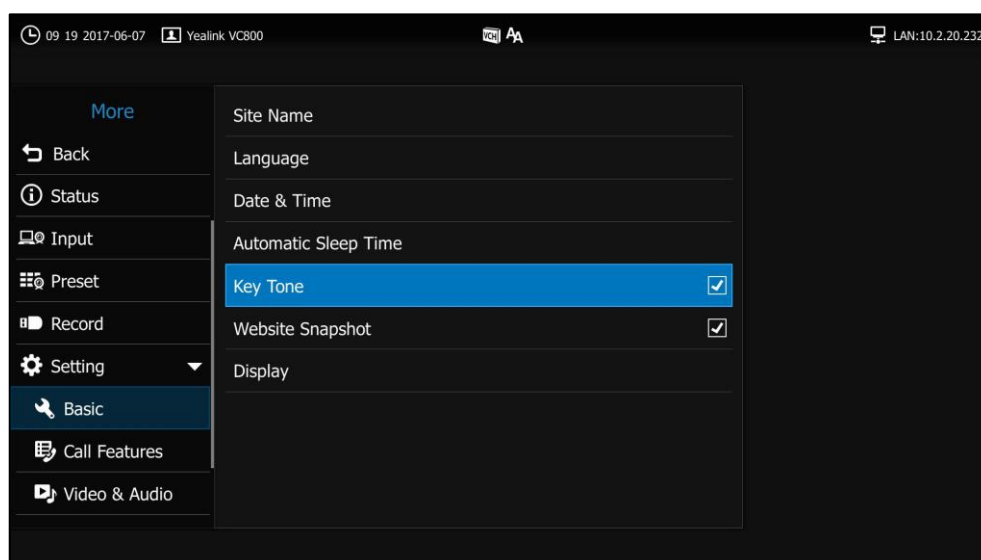

5. Press  to return to the idle screen.











Key tone is configurable via web user interface at the path **Setting->General-> Key Tone**.

Website Snapshot

You can enable the website snapshot feature to allow the user to watch video images captured by local camera on the web user interface.

Website snapshot is configurable via the remote control only and it is enabled by default.

To configure the website snapshot via the remote control:

1. Select  (**More** menu).
2. Press  or  to scroll to **Setting** and then press  to expand the menu.
3. Press  or  to scroll to **Basic** and then press  to enter submenu.
4. Press  or  to scroll to **Website Snapshot**, and then press  to enable or disable this feature.

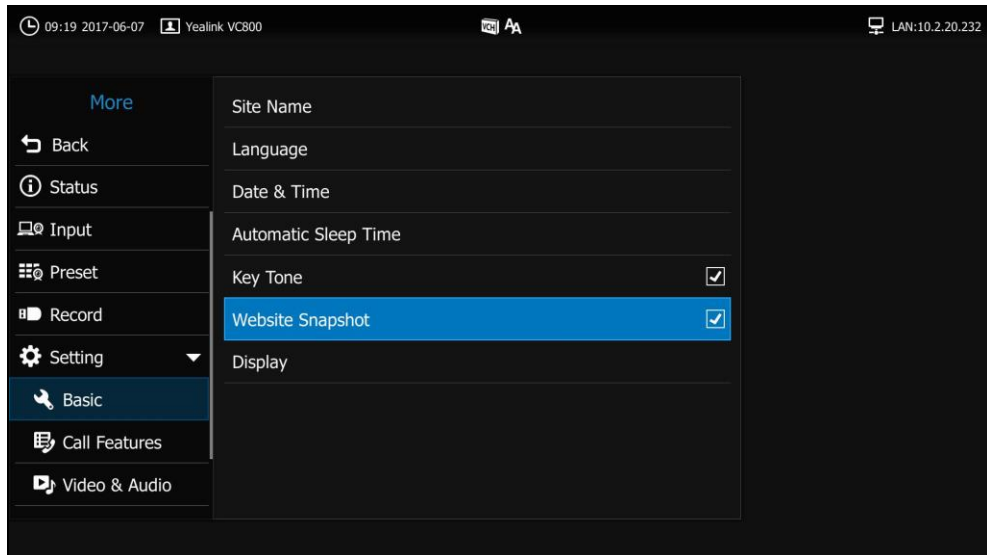







5. Press  to return to the idle screen.

To watch video images via the web user interface at the path **Home**.

Adjusting Zoom Level of the Display Device

You can adjust zoom level of the display device according to your needs. It is configurable via the remote control only.

To adjust zoom level of the display device via the remote control:

1. Select  (**More** menu).
2. Press  or  to scroll to **Setting** and then press  to expand the menu.
3. Press  or  to scroll to **Basic** and then press  to enter submenu.

4. Press ▲ or ▼ to scroll to **Display**, and then press **OK**.
5. Press ◀ or ▶ to adjust the **Display(90%-100%)** slider to change the zoom level of the display device.

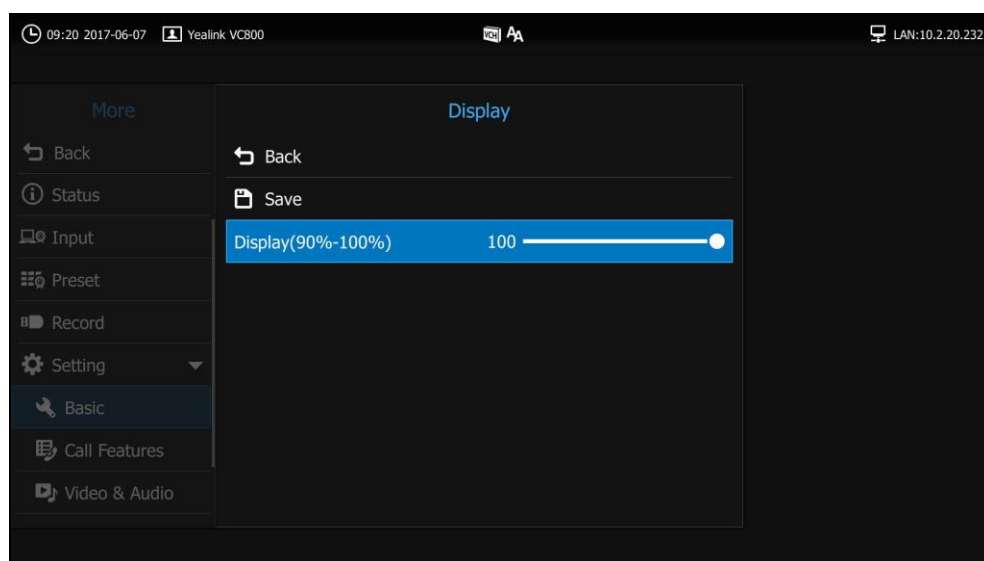

6. Press ▲ or ▼ to select **Save** and then press **OK** to accept the change.
7. Press  to return to the idle screen.

Volume Settings

You can use the remote control or CP960 conference phone to adjust the ringer volume of the system when it is idle or ringing. You can also adjust the receiver volume of engaged audio devices when the system is in use.

To adjust the volume when the system is idle or ringing:

Do one of the following:

- Press  or  on the remote control to adjust the ringer volume of the system.

The current ringer volume of the system is displayed on the left of the display device.

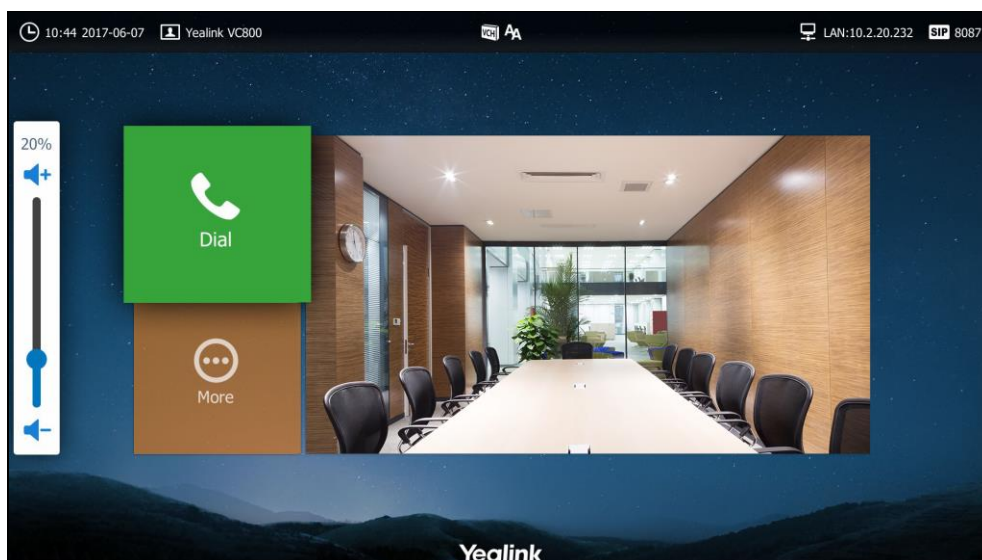

- Press volume key on the CP960 conference phone to adjust the ringer volume. The CP960's touch screen displays the current ringer volume.

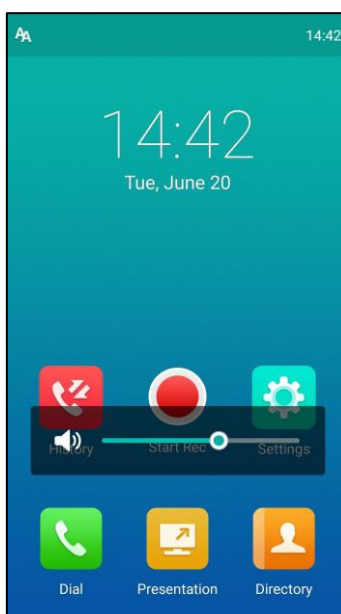

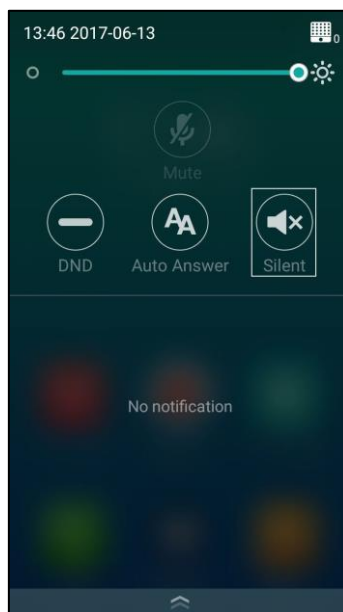

The display device will display the ringer volume simultaneously.

- Swipe down from the top of the CP960's touch screen to enter the control center.
Tap  to set the ringer volume to 0.



Note If ringer volume is adjusted to 0, the  icon will appear on the display device. The  icon will appear on the CP960's touch screen.

To adjust the volume when the system is during a call:

- Press  or  on the remote control to adjust the receiver volume of the system.
The current receiver volume of the system is displayed on the left of the display device.

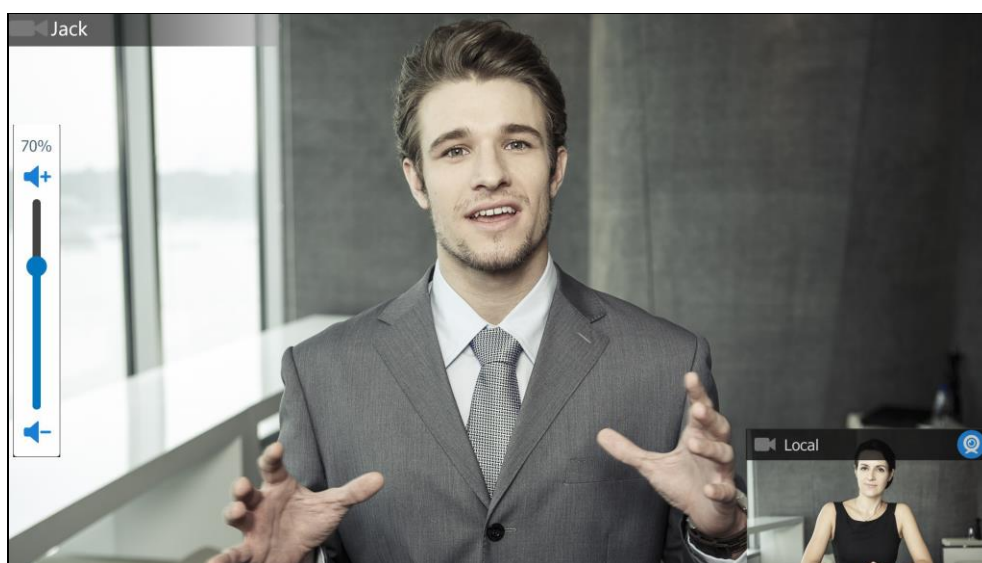

- Press volume key on the CP960 conference phone to adjust the receiver volume of the system.

The CP960's touch screen displays the current receiver volume.

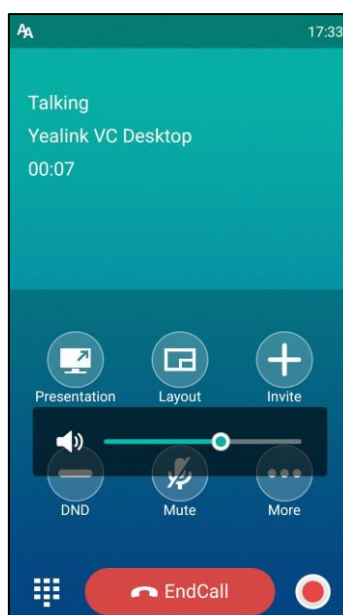

The display device will display the receiver volume simultaneously.

Note

If the CP960 conference phone is not the active audio device of the system, you can still use it to adjust the system volume.

Hiding IP Address

The status bar of the display device displays IP address. You can choose to hide IP address on the status bar. Hiding IP address feature is configurable via web user interface only.

To hide IP address via web user interface:

1. Click on **Setting->General**.

2. Select **Enabled** from the pull-down list of **Hide IP Address**.

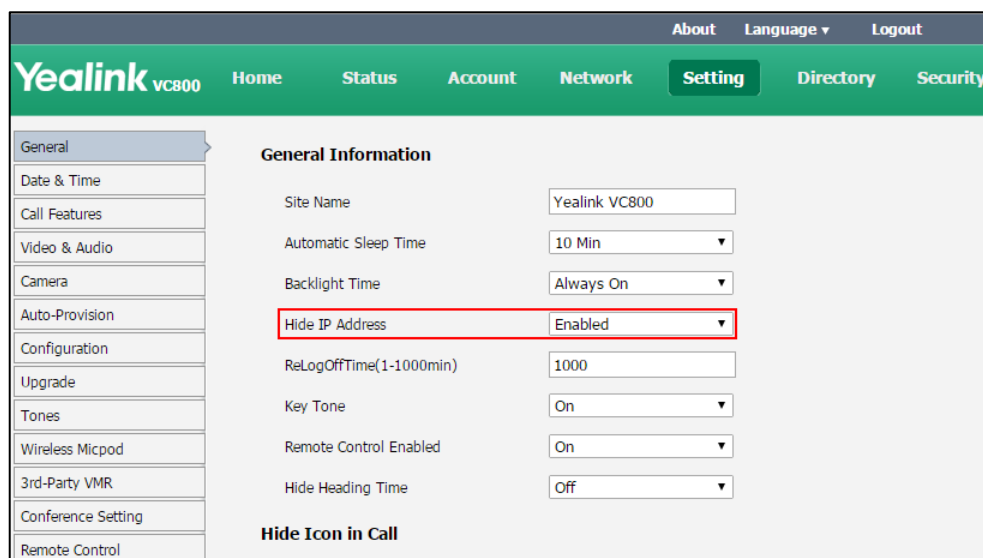

3. Click **Confirm** to accept the change.

Hiding Heading Time

The status bar of the display device displays current time and date. You can choose to hide time and date on the status bar. Hiding heading time feature is configurable via web user interface only.

To hide heading time via web user interface:

1. Click on **Setting->General**.
2. Select the desired value from the pull-down list of **Hide Heading Time**.

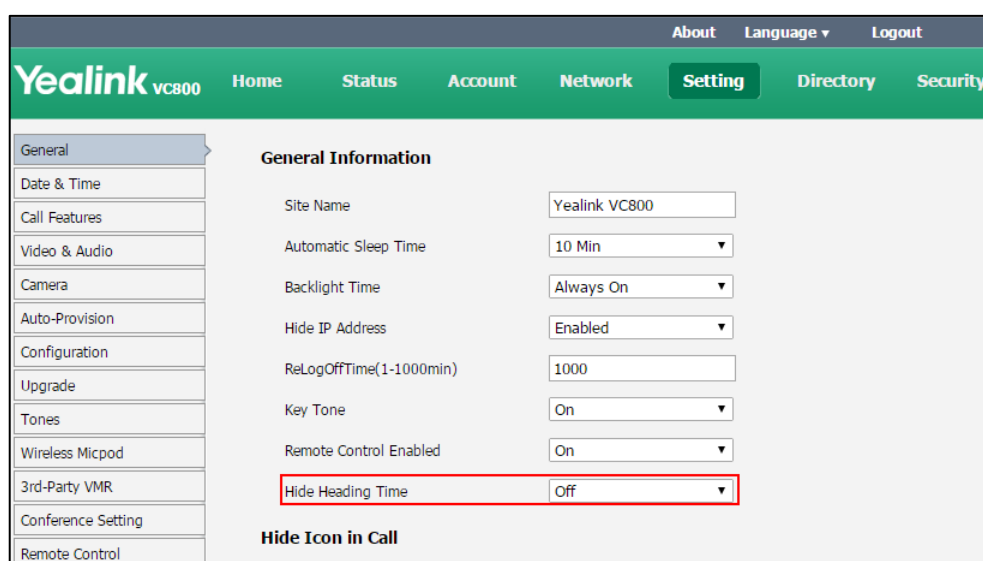

3. Click **Confirm** to accept the change.

Note This feature will not affect the time displayed on the status bar of CP960 conference phone.

Hiding Icons in a Call

During a call, the display device displays some icons to indicate the call status. You can hide these icons as needed to achieve the best video effects. Hiding icons in a call feature is configurable via web user interface only.

To hide icons in a call via web user interface:

1. Click on **Setting->General**.
2. Select the desired values from the pull-down lists of **Time Icon**, **Mute Icon**, **Camera Icon**, **Recording Icon**, **Sitename Icon**, **Hold Icon**, **Encrypt Icon**, **OutPut Mute Icon**, and **SecondScreen Icon**.
 - If you select **Disabled**, the system displays corresponding icons during a call.
 - If you select **Hide with UI**, the system displays corresponding icons during a call, but the icons will disappear when the status bar is hidden.
 - If you select **Enabled**, the system does not display corresponding icons during a call.

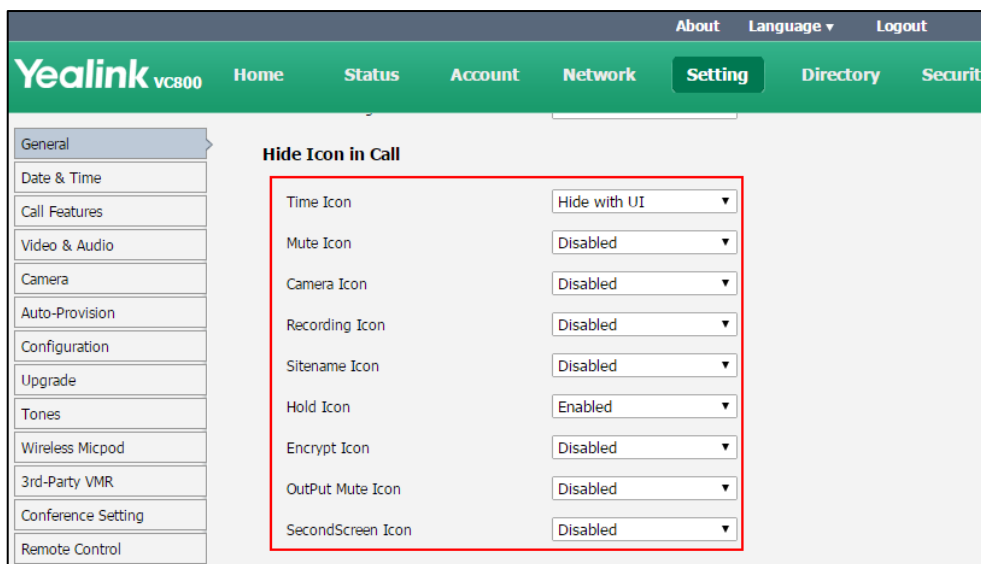

3. Click **Confirm** to accept the change.

Custom Key Type

You can configure a custom type to the  key on the remote control. It is configurable via web user interface only.

To configure a custom key type via web user interface:

1. Click on **Setting->Remote Control**.
2. Select the desired value from the pull-down list of **Custom Key Type**.

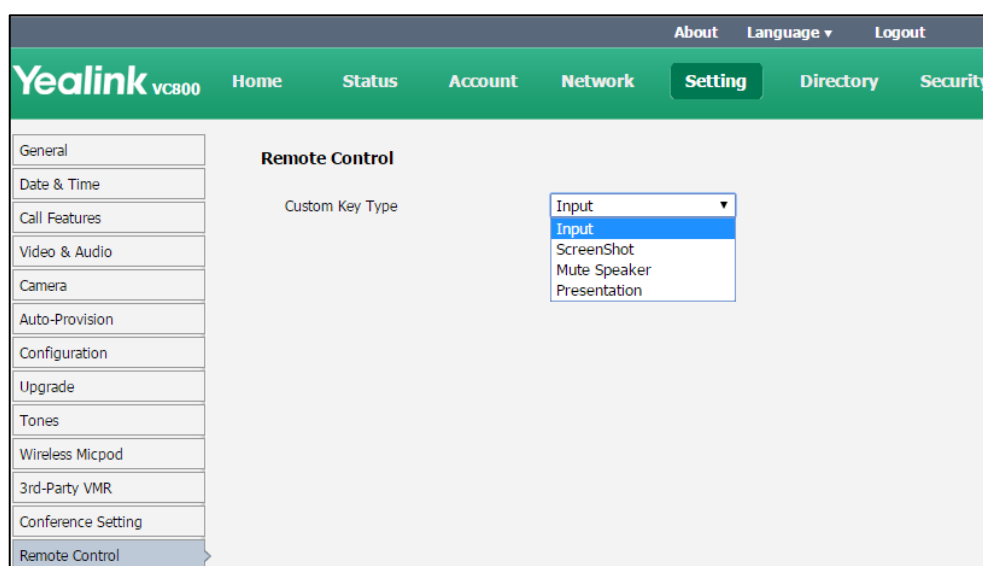

- **Input:** press to select the video input source.
 - **Screencapture:** press to capture screen.
 - **Mute Speaker:** press to mute or unmute the speaker.
 - **Presentation:** press to start or stop presentation.
3. Click **Confirm** to accept the change.

USB Configuration

If you have high requirement for data security, you can disable the USB feature. If you disable the USB feature, you cannot view the videos and screenshots stored in the USB flash driver via the remote control, and cannot record video or capture screenshot.

To configure USB configuration via web user interface:

1. Click on **Setting->Video & Audio**.

- Select the desired value from the pull-down list of **USB Enable**.

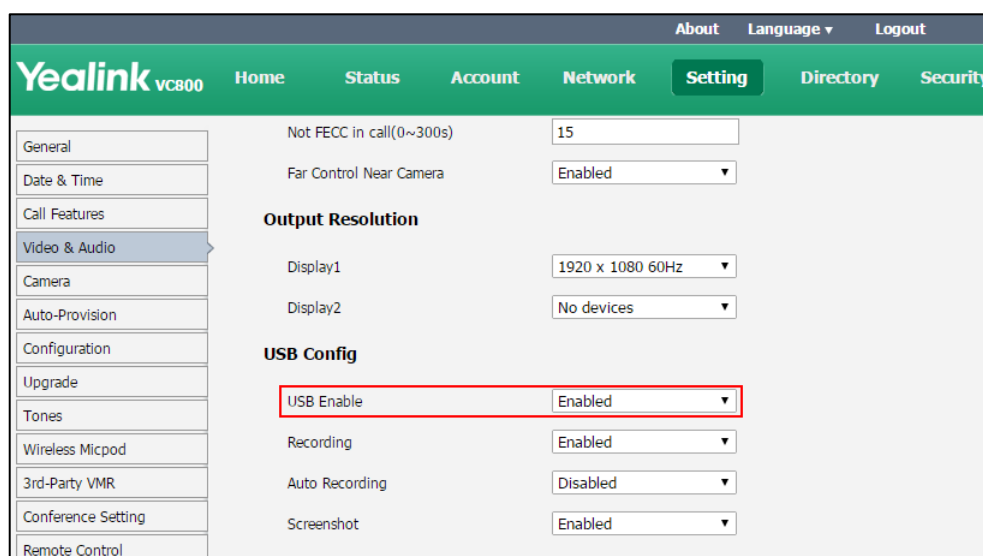

- Click **Confirm** to accept the change.
A dialog box pops up to prompt that settings will take effect after a reboot.
- Click **Confirm** to reboot the system immediately.

Directory

VC800 system can display: local contacts, Yealink Cloud contacts and YMS contacts.

- Local contacts:** The VC800 system can store up to 500 local contacts and 100 conference contacts (you can configure conference contacts only when multipoint license is imported to the VC800 system). A conference contact consists of one or more local contacts. You can establish a conference call quickly by calling conference contacts.

You can import or export local contact list to different systems to share the local directory. The system only supports the XML and CSV format contact lists. You can manage local directory via web user interface, remote control and the CP960 conference phone.

- Yealink Cloud contacts:** If you log into the Yealink VC Cloud Management Service platform, Yealink Cloud contacts will display in your directory menu. Yealink Cloud contacts are created by your administrator. Only administrator can add, edit and delete Yealink Cloud contacts on the Yealink VC Cloud management service, these operations will update to VC800 automatically. You do not have the permission to do these operations on your VC800. You can only search and place calls to the Yealink Cloud contacts. For more information on Yealink VC Cloud management service, refer to [Yealink VC Cloud Management Service Administrator Guide](#).
- YMS contacts:** If you log into the Yealink Meeting Server, enterprise directory will display in your directory menu. YMS contacts are created by your administrator. Only administrator can add, edit and delete YMS contacts on the Yealink Meeting Server (YMS),

these operations will update to VC800 automatically. You do not have the permission to do these operations on your VC800. You can only search and place calls to the YMS contacts. For more information on Yealink Meeting Server, refer to [Yealink Meeting Server Administrator Guide](#).

Note

StarLeaf/Zoom/BlueJeans/Pexip/Mind platform does not provide Cloud contacts for video conferencing system.













This chapter provides operating instructions for the directory. Topics include:

- [Adding Contacts](#)
- [Placing Calls to Contacts](#)
- [Editing Contacts](#)
- [Deleting Contacts](#)
- [Searching for Contacts](#)
- [Search Source List in Dialing](#)
- [Importing/Exporting Local Contact Lists](#)

Adding Contacts

You can add local contacts and conference contacts via the remote control or web user interface.

To add a local contact via the remote control:

1. Select  (**Dial** menu) or press  to enter the pre-dialing screen.
2. Press  to return to the menu.
3. Press  or  to scroll to **Directory** and then press  to enter submenu.
4. Press  or  to scroll to **New Contact** and then press .
5. Enter contact name in the **Name** field.
6. Enter contact number or IP address in the **Number** field.
7. Press  or  to scroll to **Add New Number**, and then press  to add more numbers.
Up to 3 numbers can be added to a local contact.
8. Select the desired contact bandwidth from the pull-down list of **Bandwidth**.

The default contact bandwidth is **Auto**. The system will select the appropriate bandwidth automatically.

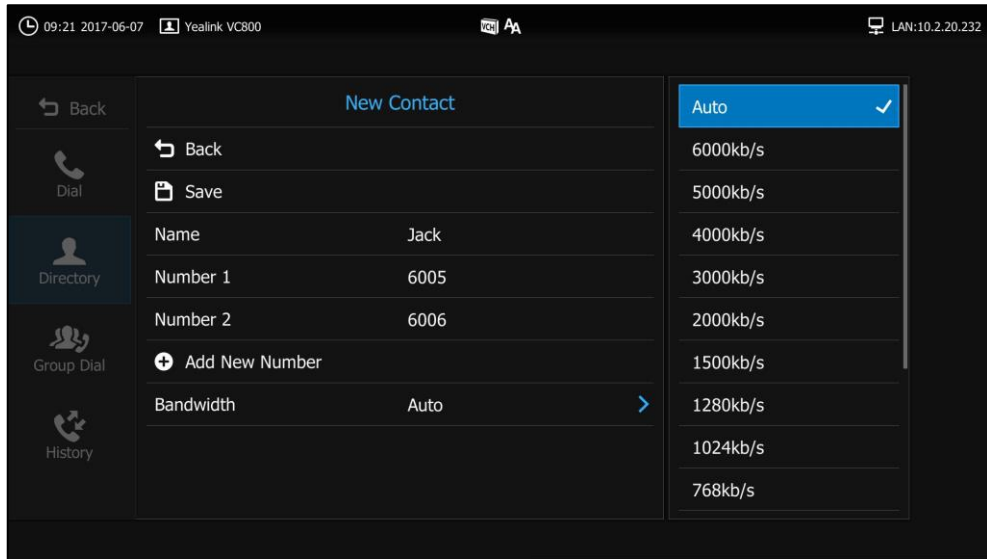

9. Press ▲ or ▼ to select **Save** and then press **OK** to accept the change.

To add a conference contact via the remote control:

1. Select **Dial** (Dial menu) or press **Dial** to enter the pre-dialing screen.
2. Press **Left Arrow** to return to the menu.
3. Press ▲ or ▼ to scroll to **Directory** and then press **Right Arrow** to enter submenu.
4. Press ▲ or ▼ to scroll to **All Contacts** and then press **OK** to select **Conference Contacts** from the pull-down list.
5. Press ▲ or ▼ to scroll to **New Conference**, and then press **OK**.
6. Enter conference name in the **Name** field.
7. Enter a few characters of the contact name or the contact number in the **Search** field.
Contacts whose name or number matches the characters entered will appear on the screen.
8. Press ▲ or ▼ to select the desired local contact, and then press **OK** to add the desired local contacts to the members List.
9. Repeat steps 7 to 8 to add more contacts.

The number of local contacts that you can add to a conference contact depends on the imported multipoint license.

For example, if you import a 24 ways license to your VC800 system, up to 24 local contacts can be added to a conference contact. For more information on multipoint license, refer to [Multipoint License](#) on page 93.

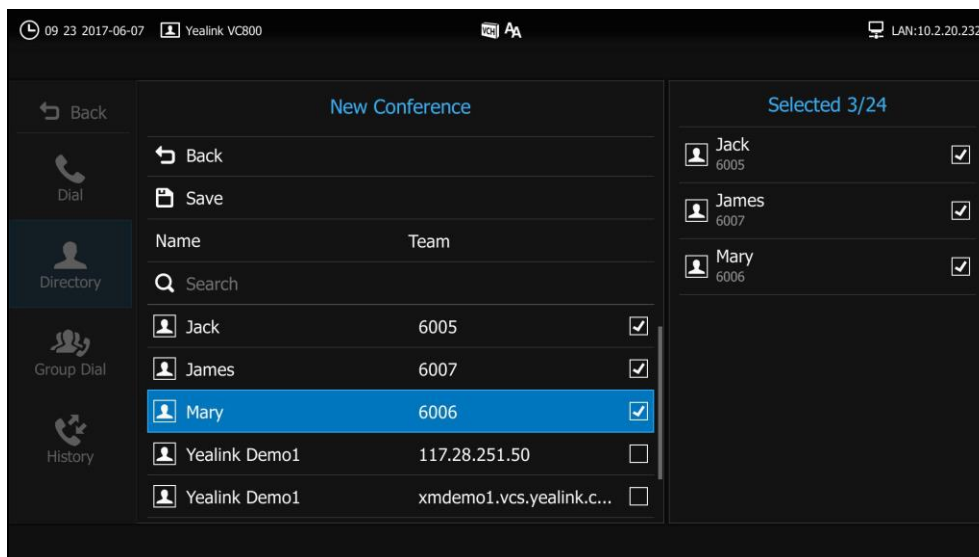

10. Press ▲ or ▼ to select **Save** and then press **OK** to accept the change.

Placing Calls to Contacts

You can place calls to contacts via the remote control, CP960 conference phone or web user interface.



To place a call to a contact via the remote control:

1. Select **Dial** (Dial menu) or press **OK** to enter the pre-dialing screen.
2. Press **Left** to return to the menu.
3. Press ▲ or ▼ to scroll to **Directory** and then press **Right** to enter submenu.
4. Select the desired contact type (**Local/Conference Contacts/Cloud/Enterprise directory**) from the pull-down list of the **All Contacts**.
5. Press ▲ or ▼ to scroll to the desired contact.

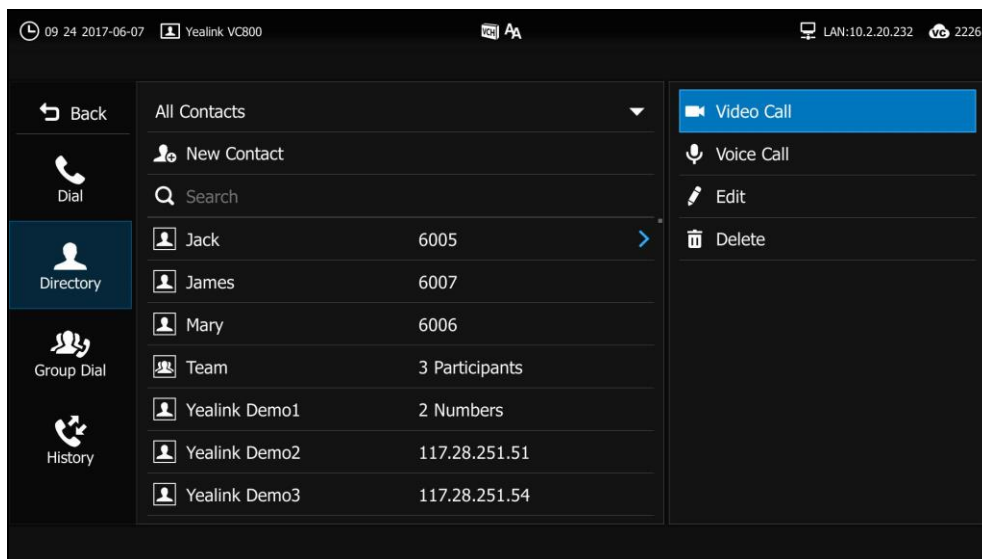
- Press **▶** to enter submenu, select the desired call type, and then press **OK** to dial out the number.



To place a call to a contact via the CP960 conference phone:



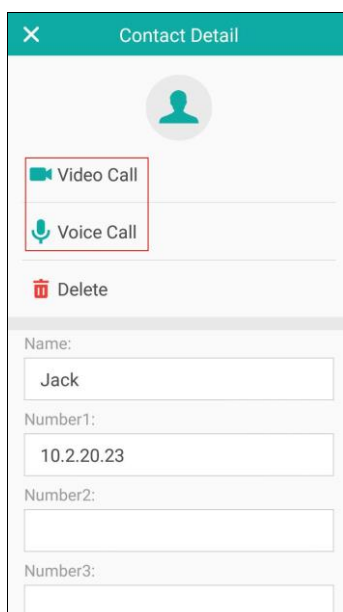









- Tap .
- Tap the **All Contacts** field.
- Tap the desired type (**Local/Conference Contacts/Cloud/Enterprise directory**) in the pop-up dialog box.
- Tap  after the desired contact.
- Tap **Video Call** or **Voice Call**.







Editing Contacts

You can edit local contacts or conference contacts via the remote control, CP960 conference phone or web user interface.

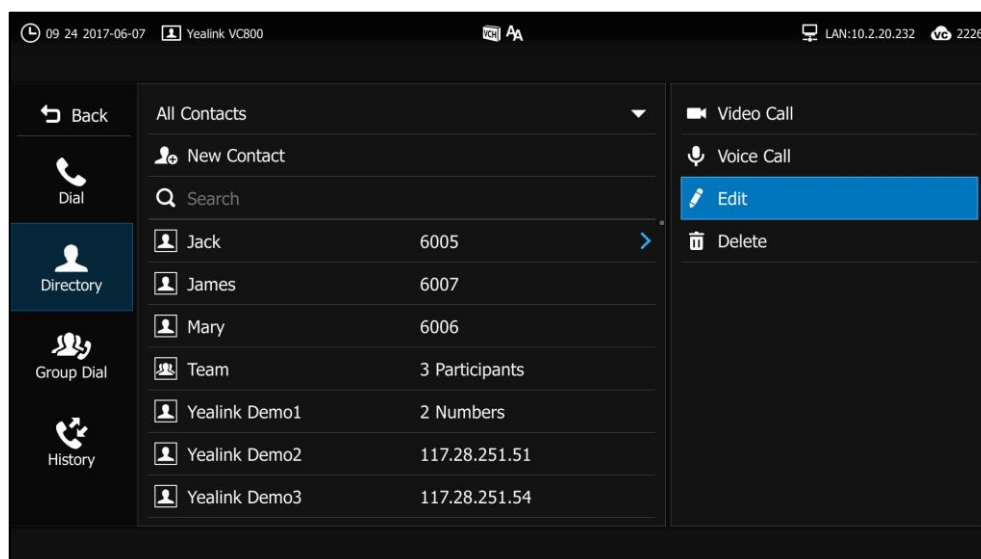
To edit a contact via the remote control:

1. Select  (**Dial** menu) or press  to enter the pre-dialing screen.
2. Press  to return to the menu.
3. Press  or  to scroll to **Directory** and then press  to enter submenu.
4. Select **Local** or **Conference Contacts** from the pull-down list of the **All Contacts**.
5. Press  or  to scroll to the desired contact.
6. Press  to enter submenu
7. Press  or  to **Edit** and then press  .





8. Edit the contact information.
9. Press  or  to select **Save** and then press  to accept the change.

To edit a contact via the CP960 conference phone:

1. Tap  .
2. Tap the **All Contacts** field.
3. Tap the desired type (**Local** or **Conference contacts**) in the pop-up dialog box.

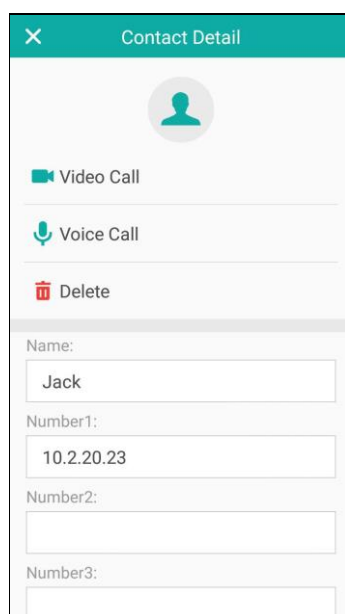
4. Tap  after the desired contact.











5. Edit the contact information.
6. Tap  to accept the change or  to cancel.

Deleting Contacts

You can delete local contacts or conference contacts via the remote control, CP960 conference phone or web user interface.

To delete a local contact or conference contact via the remote control:

1. Select  (**Dial** menu) or press  to enter the pre-dialing screen.
2. Press  to return to the menu.
3. Press  or  to scroll to **Directory** and then press  to enter submenu.
4. Press  or  to scroll to the desired contact.
5. Press  to enter submenu.

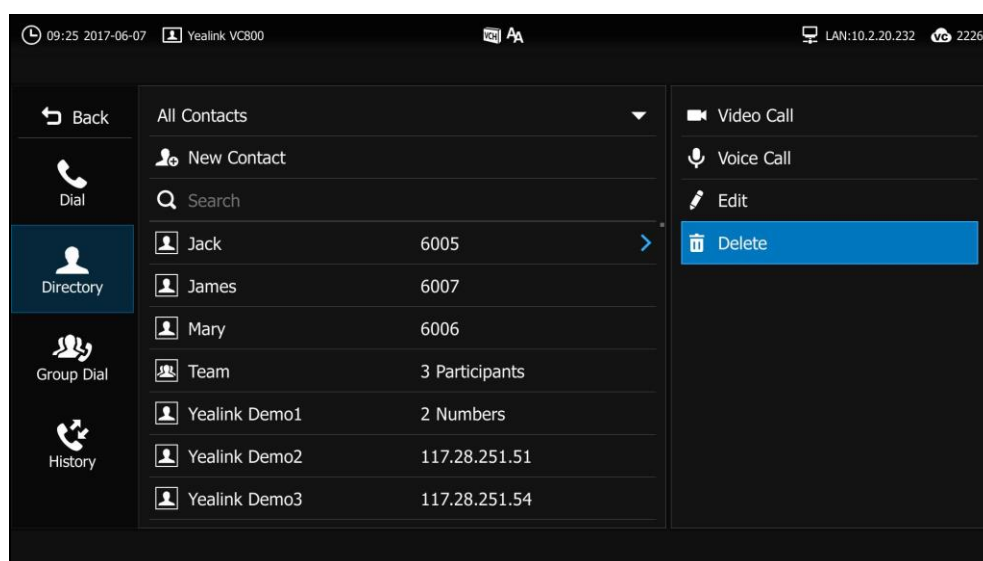

- Press ▲ or ▼ to **Delete** and then press  .



The display device prompts “Delete selected item?”

- Press ▲ or ▼ to highlight **OK**, and then press  to delete the contact.

To delete a contact via the CP960 conference phone:

- Tap  .
- Tap the **All Contacts** field.
- Tap the desired type (**Local** or **Conference contacts**) in the pop-up dialog box.
- Tap  after the desired contact.
- Edit the contact information.
- Tap **Delete**.

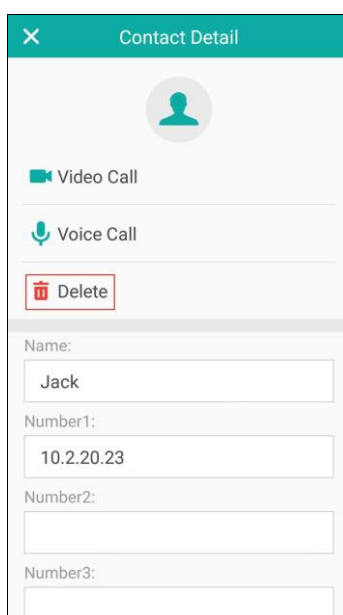

The touch device prompts “Delete selected item?”







7. Tap **OK** to accept the change or **Cancel** to cancel.

Searching for Contacts

You can search local contacts and conference contacts via the remote control, CP960 conference phone or web user interface.

If you log into the Yealink VC Cloud Management Service platform or Yealink Meeting Server, you can also search Yealink Cloud contacts or YMS contacts via the remote control or CP960 conference phone.

To search for contacts via the remote control:

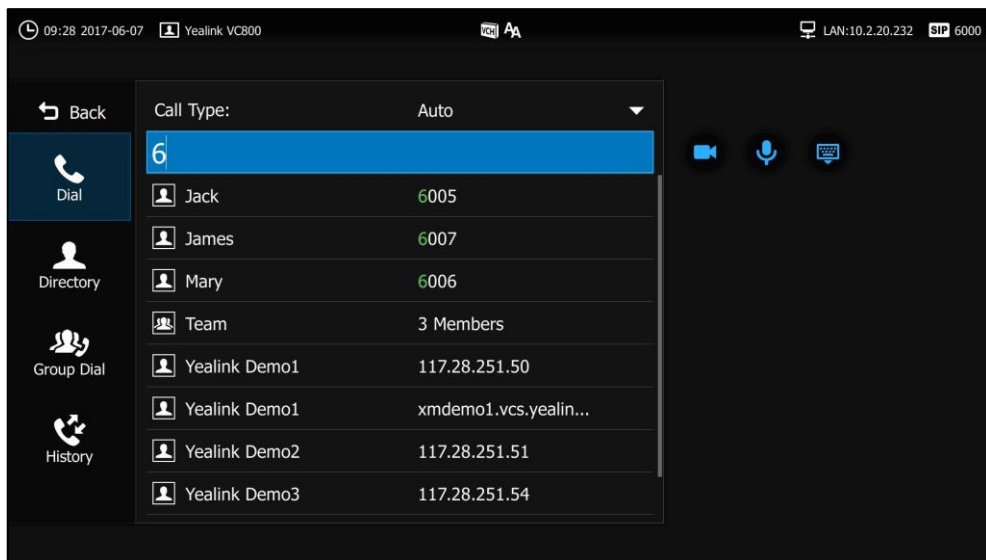

1. Select  (**Dial** menu) or press  to enter the pre-dialing screen.
2. Press  to return to the menu.
3. Press  or  to scroll to **Directory** and then press  to enter submenu.
4. Enter a few or all characters of the contact name or numbers in the **Search** field.

The contacts whose names or phone numbers match the characters entered will appear on the display device.



5. You can press  or  to scroll to the desired contact, and then call or edit this contact.

To search a contact via the CP960 conference phone:

1. Tap  .
2. Tap  .

3. Enter a few or all characters of the contact name or numbers.

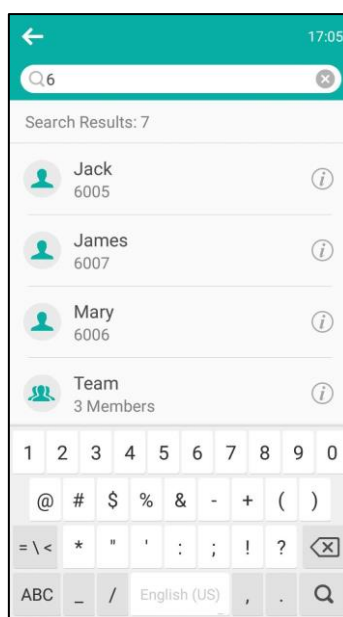

The contacts whose names or phone numbers match the characters entered will appear on the touch screen.

Local directory is configurable via web user interface at the path **Directory->Local Directory**.

Search Source List in Dialing

You can search for a contact from the desired lists when the phone is in the pre-dialing screen. The lists can be History, Local Directory, Cloud Contacts, YMS contacts and LDAP.

Note Cloud contacts and YMS contacts appear in the search source list only when you log into the Yealink VC Cloud Management Service or register a YMS account.

In the pre-dialing screen, when you enter a few characters, the system will search the matched contacts from the enabled search source lists, and display the result in the dialing screen.

If you want to match the LDAP list, LDAP are configured already. For more information on how to configure LDAP, contact your system administrator.



To configure search source list in dialing via web user interface:

1. Click on **Directory->Setting**.
2. In the **Search Source List In Dialing** block, select the desired list from the **Disabled** column and click .

The selected list appears in the **Enabled** column.

3. Repeat step 2 to add more lists to the **Enabled** column.
4. (Optional.) To remove a list from the **Enabled** column, select the desired list and then

click .

- To adjust the display order of the enabled list, select the desired list, and click  or .

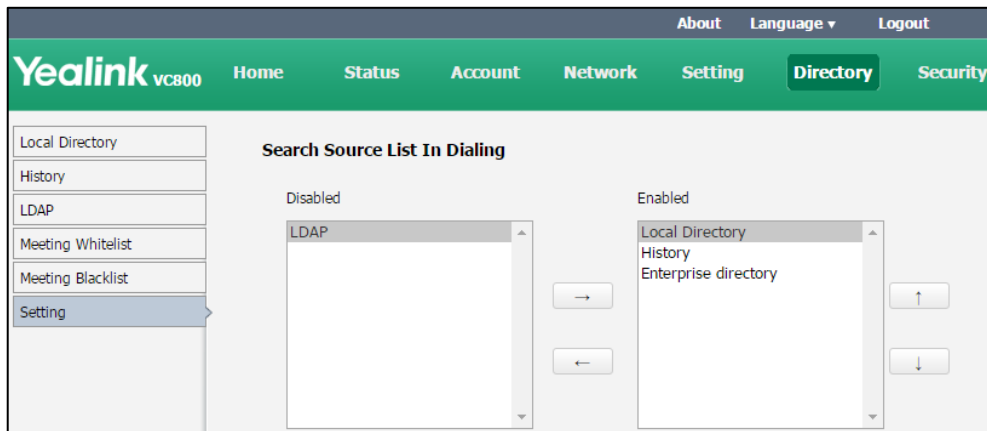





- Click **Confirm** to accept the change.

Note

Search source list in dialing is only configurable via web user interface.

To place a call via search source lists:

- Select  (**Dial** menu) or press  to enter the pre-dialing screen.
- Enter a few or all characters of the contact name or numbers.
The contacts whose names or phone numbers match the characters entered will appear on the display device.
- Press  or  to scroll to the desired contact, and then press  to call the contact.

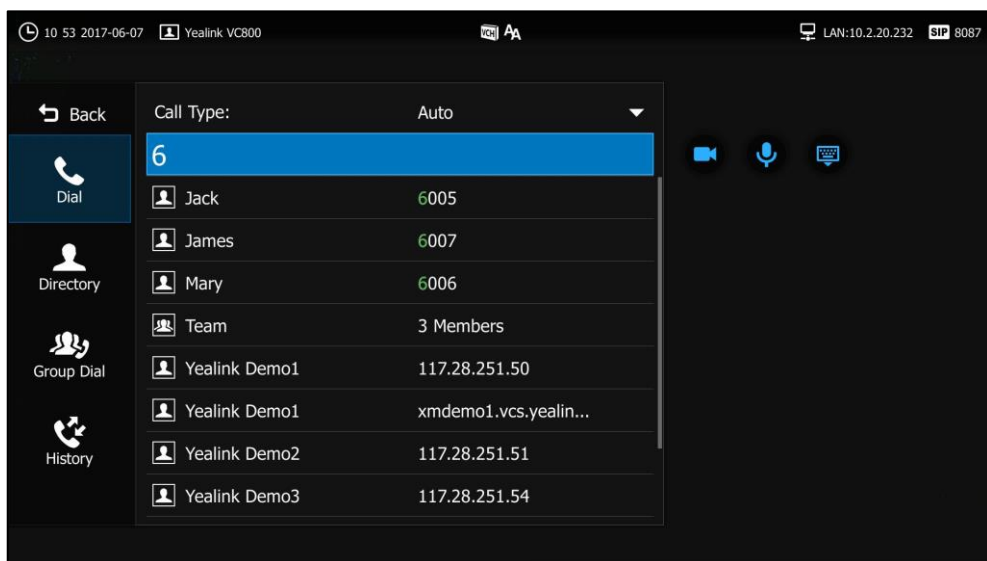

Importing/Exporting Local Contact Lists

You can import or export the local contact list to share local contacts between different systems or between system and application software (e.g., Outlook).

The VC800 video conferencing system only supports the XML and CSV format local contact lists. You can only import or export the local contact list via the web user interface.

To import an XML file of the local contact lists via the web user interface:

1. Click on **Directory**->**Local Directory**.
2. Select **Import** from the pull-down list of **Import/Export**.
3. Click **Browse** to locate a local contact list file (file format must be *.xml) from your local system.

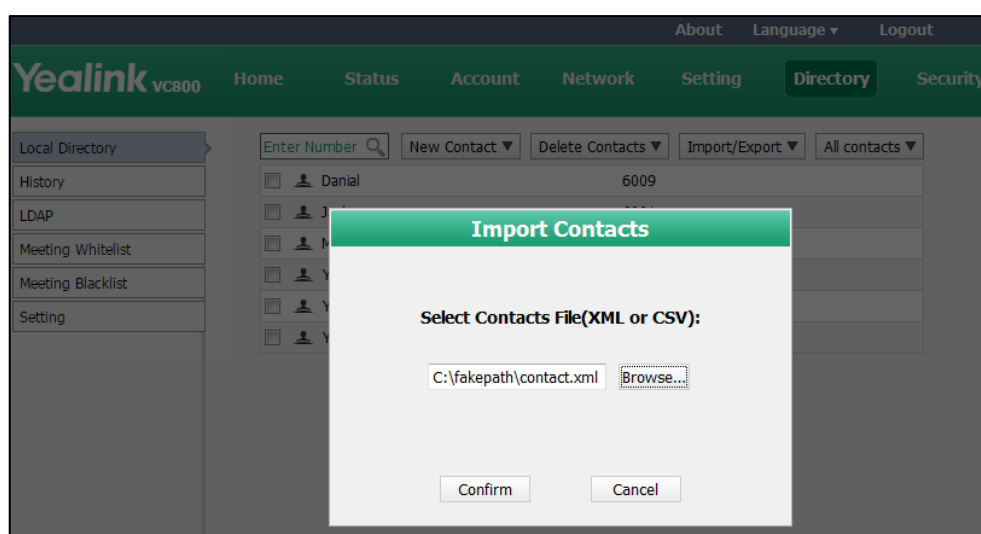

4. Click **Confirm** to import the local contact list.
The web user interface prompts "The original contact will be covered, continue?".
5. Click **Confirm** to complete importing the local contact list.
The web user interface prompts "Contacts imported successfully!".

To import a CSV file of local contact lists via the web user interface:

1. Click on **Directory**->**Local Directory**.
2. Select **Import** from the pull-down list of **Import/Export**.
3. Click **Browse** to locate a local contact list file (file format must be *.csv) from your local system.

4. Click **Confirm**.

The web user interface is shown as below:

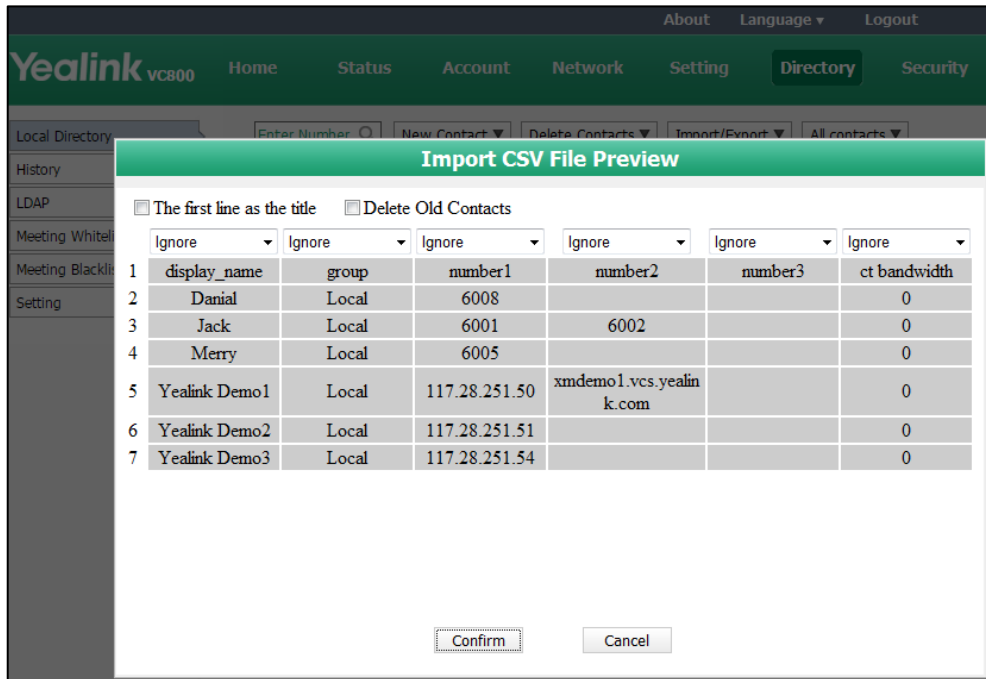

5. (Optional.) Check the **The first line as the title** checkbox.

It will prevent importing the title of the local contact information which is located in the first line of the CSV file.

6. (Optional.) Check the **Delete Old Contacts** checkbox.

It will delete all existing local contacts while importing the contact list.

7. Select the desired value from the pull-down list.

- If **Ignore** is selected, this column will not be imported to the system.
- If **Display Name** is selected, this column will be imported to the system as the local contact's name.
- If **number** is selected, this column will be imported to the system as the local contact's number.

- If **Bandwidth** is selected, this column will be imported to the system as the local contact's bandwidth.

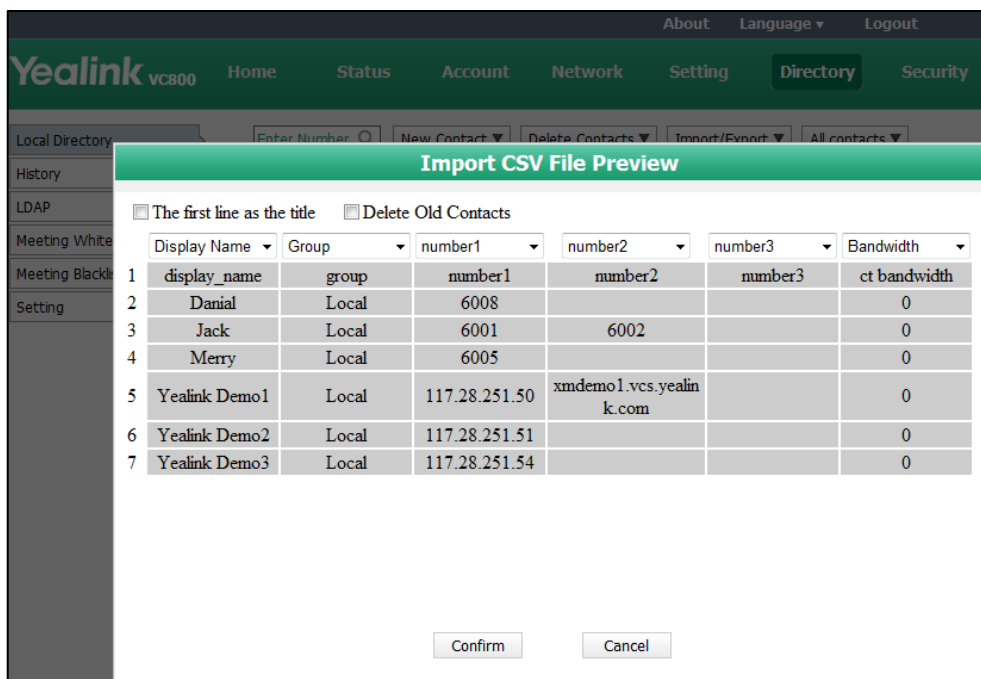

8. Click **Confirm** to complete importing the local contact list.

The web user interface prompts "Contacts imported successfully!".

Note

The display name must be imported to the system. If not, the CSV file cannot be imported.

To export a XML file of the local contact list via web user interface:

1. Click on **Directory->Local Directory**.
2. Select **Export XML** from the pull-down list of **Import/Export**.

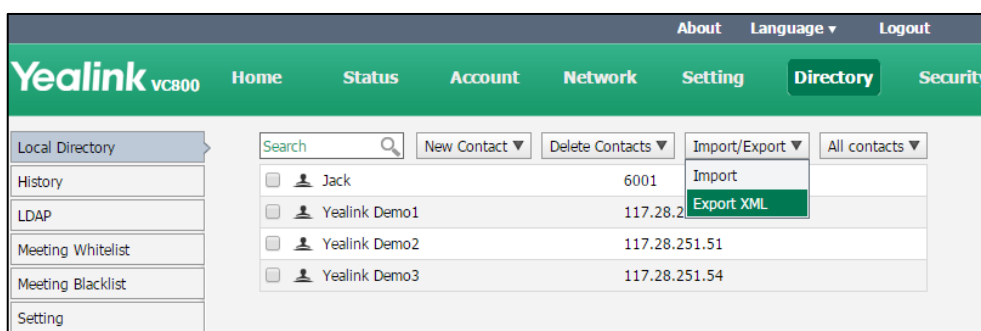











The local contact list is saved to your local system.

Call History Management

The VC800 video conferencing system maintains call history lists of All Calls, Missed Calls, Placed Calls and Received Calls. The system supports up to 100 history lists. You can view the call history, place a call or delete an entry from the call history entries (local entries and Cloud entries).

To log call history on the system, you need to enable the history record feature in advance. The history record feature is enabled by default, and you can configure it via the remote control or web user interface.

To configure the history record feature via the remote control:

1. Select  (**More** menu).
2. Press  or  to scroll to **Setting** and then press  to expand the menu.
3. Press  or  to scroll to **Call Features** and then press  to enter submenu.
4. Press  or  to scroll to **History Record**, and then press  to enable or disable this feature.

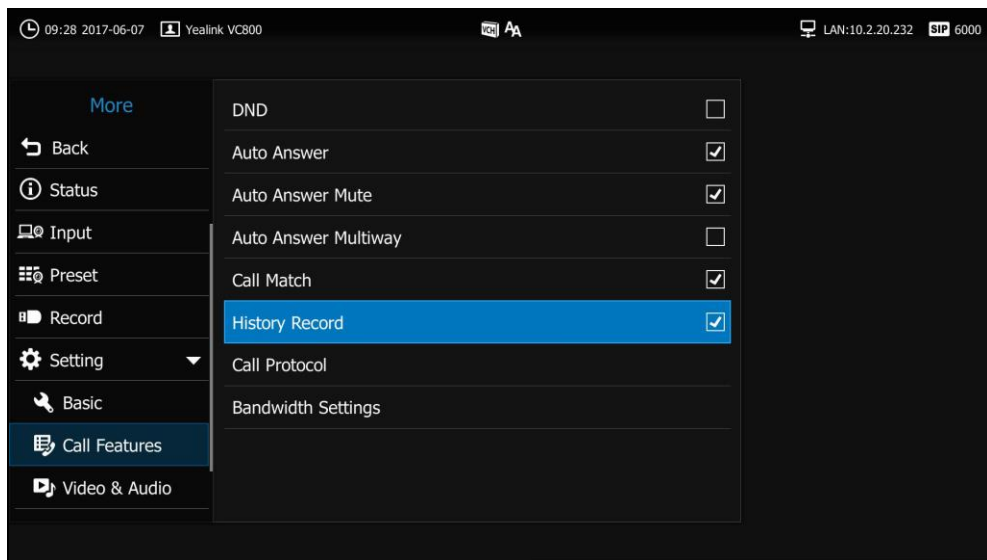



5. Press  to return to the idle screen.

The history record feature is configurable via web user interface at the path **Setting->Call Features->History Record**.

Viewing Call History

You can view call history via the remote control, CP960 conference phone or web user interface.

To view call history via the remote control:

1. Select  (**Dial** menu) or press  to enter the pre-dialing screen.

2. Press ◀ to return to the menu.
3. Press ▲ or ▼ to scroll to **History** and then press ▶ to enter submenu.
The display device shows recent call history.
4. Select the desired list from the pull-down list of **All Calls**.
5. Press ▲ or ▼ to view the desired call history.

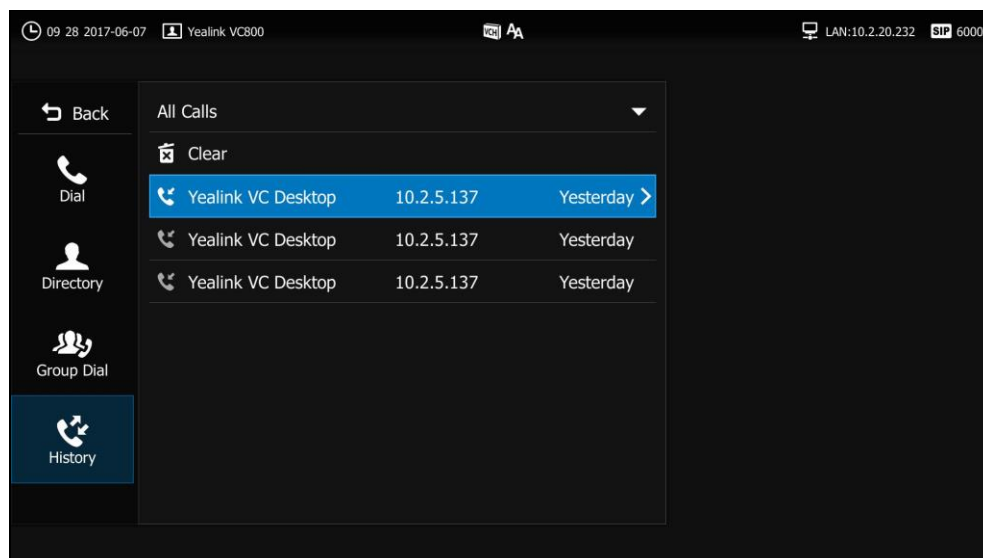

To view call history via the CP960 conference phone:

1. Tap .
The touch screen displays all call records.



2. Tap the **All Calls** field.
3. Tap the desired list (**All Calls**, **Missed Calls**, **Placed Calls**, or **Received Calls**) in the pop-up dialog box.









4. Tap  after the desired call records.
5. The touch screen displays details about this call record.

Call history can be viewed via the web user interface at the path **Directory->History**.



Placing a Call from the Call History List

You can place a call from the call history list via the remote control, CP960 conference phone or web user interface.

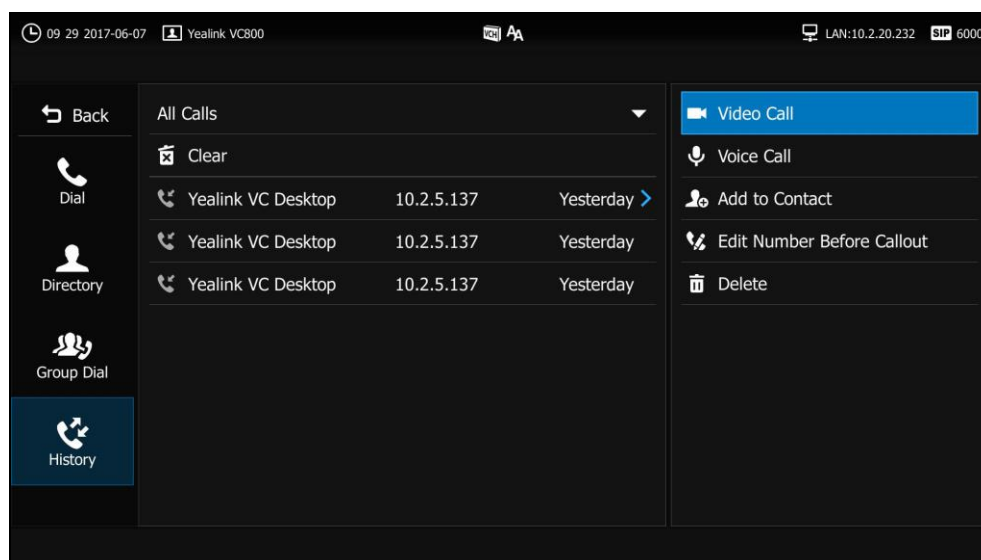

To place a call from the call history list via the remote control:

1. Select  (**Dial** menu) or press  to enter the pre-dialing screen.
2. Press  to return to the menu.
3. Press  or  to scroll to **History** and then press  to enter submenu.
The display device shows recent call history.
4. Select the desired list (**Missed Calls**, **Placed Calls** or **Received Calls**) from the pull-down list of **All Calls**.
5. Press  or  to scroll to the desired call history.



6. Press  to select video call or voice call, and then press  to dial out the number.

To place a call from the call history list via the CP960 conference phone:

1. Tap .
The touch screen displays all call records.
2. Tap the **All Calls** field.
3. Tap the desired list (**All Calls**, **Missed Calls**, **Placed Calls**, or **Received Calls**) in the pop-up dialog box.
4. Tap  after the desired call records.



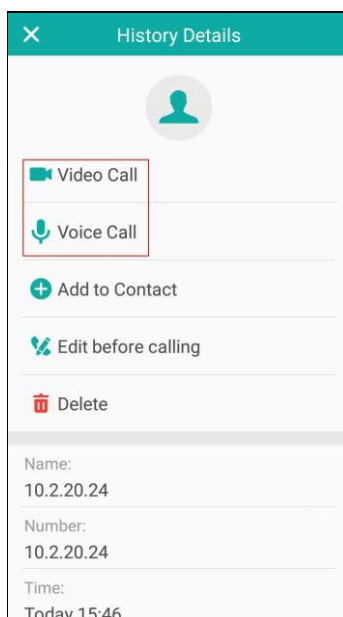





5. Tap **Video Call** or **Voice Call**.



Deleting an Entry from the Call History List

You can delete an entry from the call history list via the remote control, CP960 conference phone or web user interface.



To delete an entry from the call history list via the remote control:

1. Select  (**Dial** menu) or press  to enter the pre-dialing screen.
2. Press  to return to the menu.
3. Press  or  to scroll to **History** and then press  to enter submenu.
The display device shows recent call history.
4. Select the desired list (**Missed Calls**, **Placed Calls** or **Received Calls**) from the pull-down list of **All Calls**.
5. Press  or  to scroll to the desired entry.
6. Press  to enter submenu.

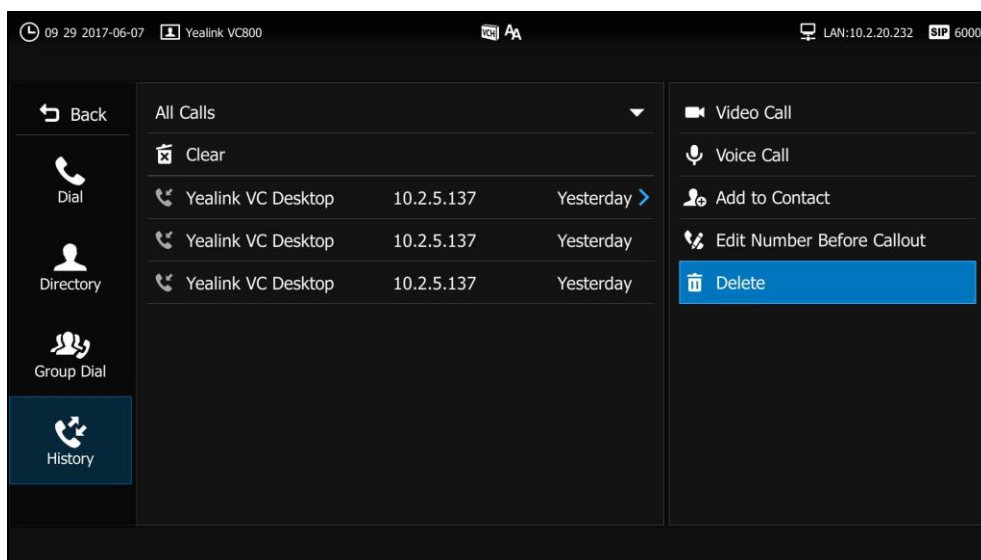
- Press ▲ or ▼ to **Delete** and then press **OK** to delete the entry.



To delete an entry from the call history list via the CP960 conference phone:



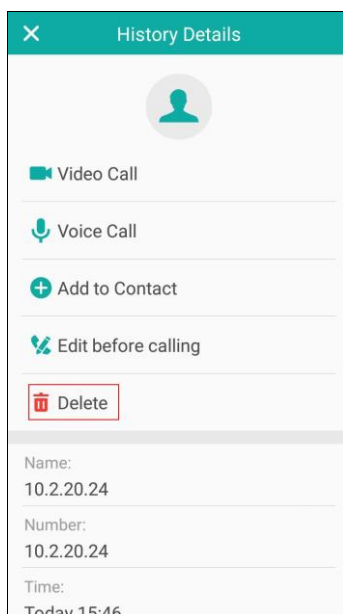





- Tap  .
The touch screen displays all call records.
- Tap the **All Calls** field.
- Tap the desired list (**All Calls**, **Missed Calls**, **Placed Calls**, or **Received Calls**) in the pop-up dialog box.
- Tap  after the desired call records.
- Tap **Delete**.



The touch device prompts "Delete selected item?"

- Tap **OK** to accept the change or **Cancel** to cancel.

To clear call history via the remote control:

1. Select  (**Dial** menu) or press  to enter the pre-dialing screen.
2. Press  to return to the menu.
3. Press  or  to scroll to **History** and then press  to enter submenu.
4. Press  or  to scroll to the **Clear**, and then press  .

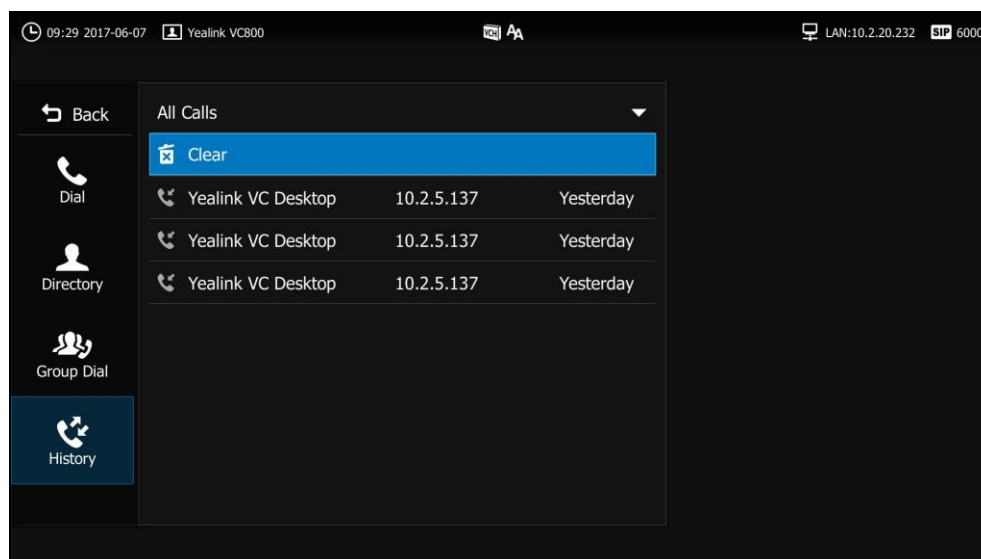









You can also select the call history list you want to clear from the pull-down list of **All Calls**, and then clear the selected list.

The display device prompt "Delete all records?".

8. Select **OK**, and then press  to clear the call history.

Adding a Local Contact from the Call History List

To add a local contact from the call history list via the remote control:

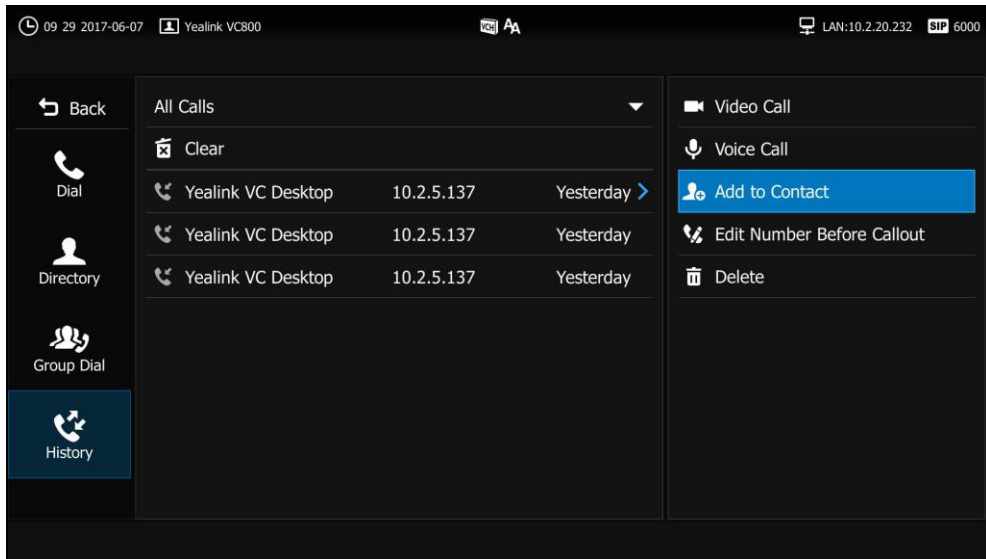

1. Select  (**Dial** menu) or press  to enter the pre-dialing screen.
2. Press  to return to the menu.
3. Press  or  to scroll to **History** and then press  to enter submenu.
4. Press  or  to scroll to the desired call history.
5. Press  to enter submenu.

- Press ▲ or ▼ to scroll to **Add to Contact**, and then press  .





- Enter contact name in the **Name** field.
You can add more than one number for the local contact. For more information, refer to [Adding Contacts](#) on page 64.
- Press ▲ or ▼ to select **Save** and then press  to accept the change.

To add a local contact from the call history list via the CP960 conference phone:

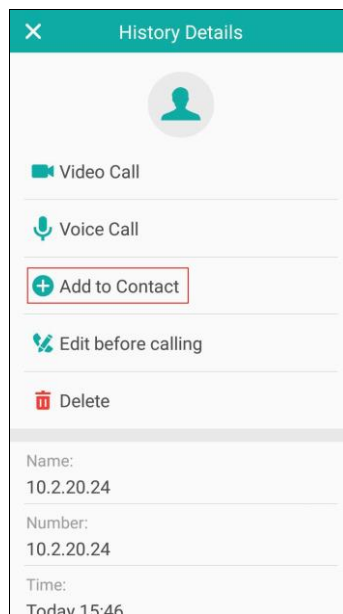
- Tap  .
The touch screen displays all call records.
- Tap  after the desired call records.
- Tap **Add to Contact**.



- Enter contact name in the **Name** field.

5. Add number for the local contact.
6. Tap  to accept the change or  to cancel.

Call history management feature is configurable via web user interface at the path **Directory->History**.











Call Protocol

The VC800 video conferencing system supports SIP and H.323 call protocols. H.323 is commonly used to communicate to other video conferencing systems. SIP is commonly used to communicate with other VoIP devices. You can configure which protocol is to be used when the system is making calls. When the **Auto** call protocol is used, the system preferentially uses the H.323 protocol to place calls. If there is no available H.323 account on the system, the system will switch to the SIP protocol. You can also specify the desired protocol for the system to place calls via the remote control or web user interface.



Note

Before configuring call protocol, ensure the remote system supports the call protocol too. For more information, contact your system administrator.

To configure the call protocol via the remote control:

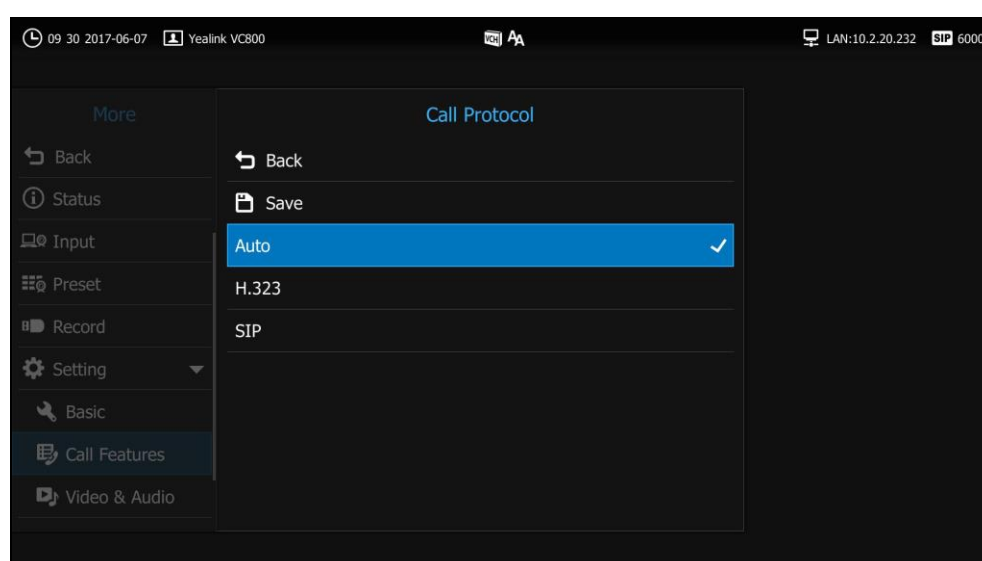
1. Select  (**More** menu).
2. Press  or  to scroll to **Setting** and then press  to expand the menu.
3. Press  or  to scroll to **Call Features** and then press  to enter submenu.
4. Press  or  to scroll to **Call Protocol** and then press .
5. Select desired type or **Auto** from the pull-down list of **Call Protocol**.



6. Press  or  to select **Save** and then press  to accept the change.

Call protocol is configurable via web user interface at the path **Setting->Call Features->Call Protocol**.

Bandwidth Settings

By default, the system automatically detects the available bandwidth and uses this connection speed. The VC800 supports connecting to other devices with different bandwidth. If a device with lower bandwidth joins a call, the video quality will stay the same or will not reduce a lot.

You can specify the uplink and downlink bandwidths for the system to achieve the best result. The uplink bandwidth refers to the max bandwidth of outgoing calls. The downlink bandwidth refers to the max bandwidth of incoming calls.











Available bandwidths for the system are: Auto, 256kb/s, 384kb/s, 512 kb/s, 640 kb/s, 768 kb/s, 1024kb/s, 1280kb/s, 1500kb/s, 2000kb/s, 3000kb/s, 4000kb/s, 5000kb/s, 6000kb/s.

You can configure the uplink and downlink bandwidth of the system via the remote control or web user interface.

Note

The actual bandwidth depends on the performance of the remote system, and is affected by the quality of the communication channel.

To configure the uplink and downlink bandwidth via the remote control:

1. Select  (**More** menu).
2. Press  or  to scroll to **Setting** and then press  to expand the menu.
3. Press  or  to scroll to **Call Features** and then press  to enter submenu.
4. Press  or  to scroll to **Bandwidth Settings** and then press  .
5. Select desired type or **Auto** from the pull-down list of **Call Protocol**.
6. Select desired bandwidth from the pull-down list of **Uplink Bandwidth**.
7. Select desired bandwidth from the pull-down list of **Downlink Bandwidth**.

If **Auto** is selected, the system will select the appropriate bandwidth automatically.

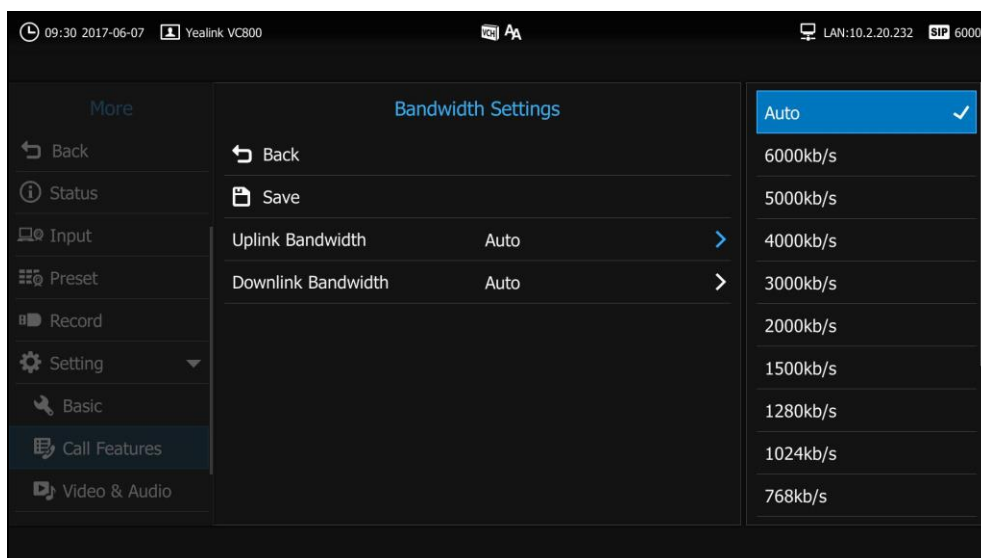

8. Press ▲ or ▼ to select **Save** and then press **OK** to accept the change.

Note

The priority of bandwidth is as follows:
 System bandwidth > Contact bandwidth (refer to [Adding Contacts](#)).
 For example: the system bandwidth is 512kbps, if contact bandwidth is set to a value greater than 512bps, then the actual contact bandwidth will be 512bps. If contact bandwidth is set to a value less than 512bps, then the actual contact bandwidth will be the value set by user.

Bandwidth is configurable via web user interface at the path **Setting->Call Features->Uplink Bandwidth/Downlink Bandwidth**.

Audio Setting

Audio Output Device

The system supports the following audio devices:





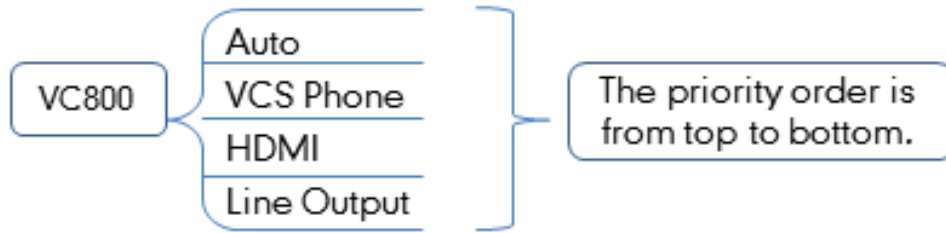





- **Auto** (audio output device with the highest priority is selected automatically)
- **VCS Phone** (CP960 Conference phone)
- **HDMI** (built-in speakerphone of the display device)
- **Line Output** (speakerphone connected to the Line Out port on the VC800 codec)

By default, the system automatically selects the audio output devices with the highest priority. The priority is: VCS Phone> HDMI>Line Output. If the audio output device with the highest priority is removed from the VC800, the VC800 will select the next highest priority device.





You can also specify the desired audio output device via the remote control or the web user interface.

To configure the audio output device via the remote control:

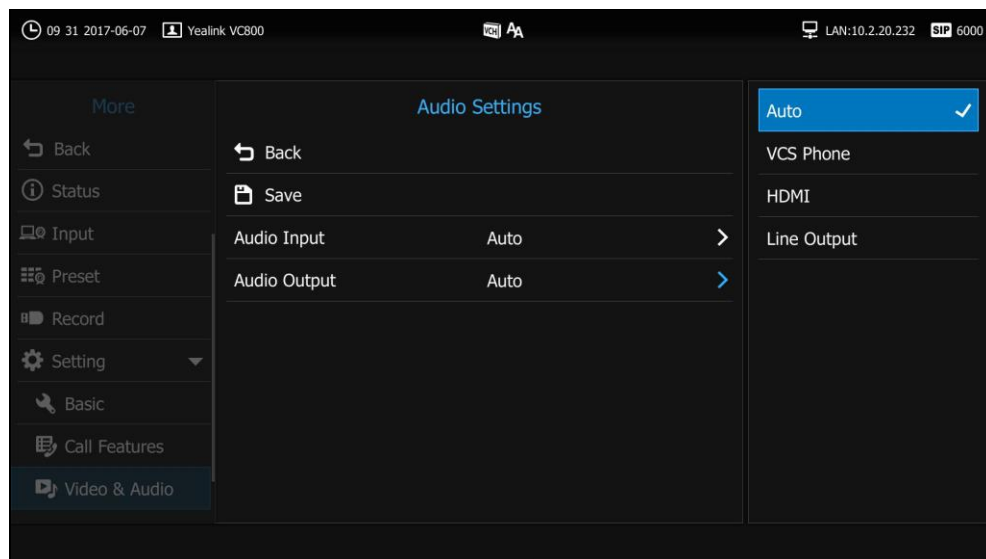
1. Select  (**More** menu).
2. Press  or  to scroll to **Setting** and then press  to expand the menu.
3. Press  or  to scroll to **Video & Audio** and then press  to enter submenu.
4. Press  or  to scroll to **Audio Settings** and then press .
5. Select desired audio output device from the pull-down list of **Audio Output**.



6. Press  or  to select **Save** and then press  to accept the change.

Audio output device is configurable via web user interface at the path **Setting->Video & Audio->Audio Output**.

Audio Input Device

The system supports the following audio input devices:





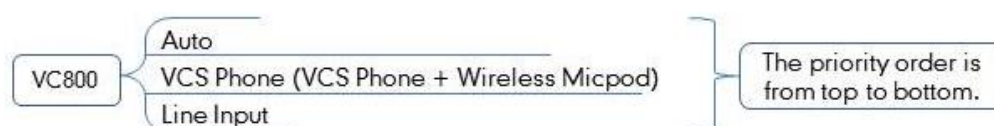





- **Auto** (select the audio input device with the highest priority)
- **VCS Phone** (CP960 conference phone)
- **VCS Phone+Wireless Micpod** (CP960 conference phone+CPW90 wireless expansion mic)
- **Line Input** (microphone connected to the Line In port on the VC800 codec)

The priority of audio input device is:







By default, the VC800 automatically selects the audio input devices with the highest priority. If you select "VCS Phone + Wireless Micpod" option, the VC800 will use CP960 conference phone and CPW90 expansion mic to pick up audio at the same time.

To configure the audio input device via the remote control:

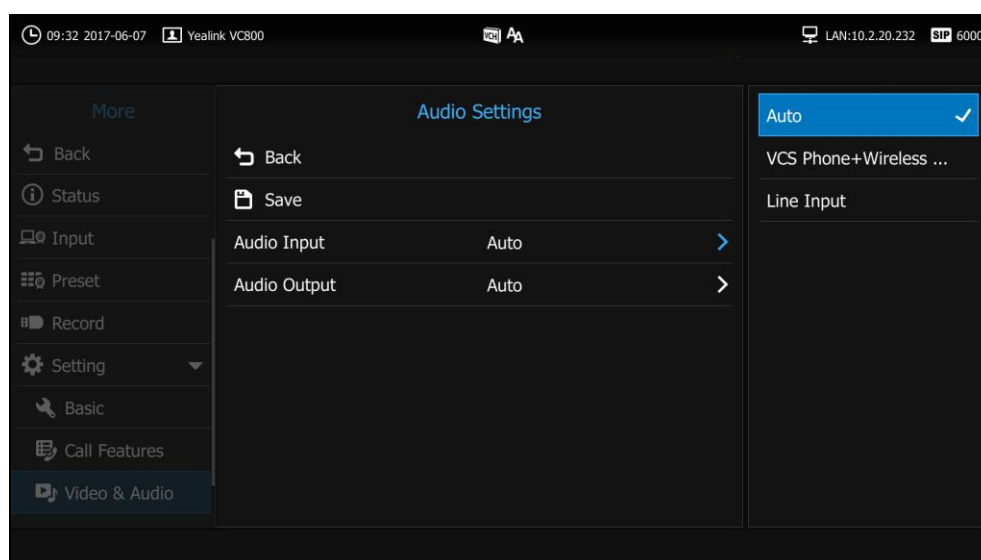
1. Select  (**More** menu).
2. Press  or  to scroll to **Setting** and then press  to expand the menu.
3. Press  or  to scroll to **Video & Audio** and then press  to enter submenu.
4. Press  or  to scroll to **Audio Settings** and then press .
5. Select desired audio output device from the pull-down list of **Audio Input**.

If **VCS Phone** is selected as the audio output device manually or automatically, the audio input device must be **VCS Phone** or **VCS Phone+Wireless Micpod**.



6. Press  or  to select **Save** and then press  to accept the change.











Audio input device is configurable via web user interface at the path **Setting->Video & Audio->Audio Input**.

Far Control Near Camera

Local video is displayed on the display device of the far site during a call. For the best view, you can enable the **Far Control Near Camera** feature to allow the far site to control the focus and angle of the local camera.

You can configure the **Far Control Near Camera** feature via the remote control or web user interface.

To configure far control near camera feature via the remote control:

1. Select  (**More** menu).
2. Press  or  to scroll to **Setting** and then press  to expand the menu.
3. Press  or  to scroll to **Video & Audio** and then press  to enter submenu.
4. Press  or  to scroll to **Far Control Near Camera** and then press  to enable or disable this feature.

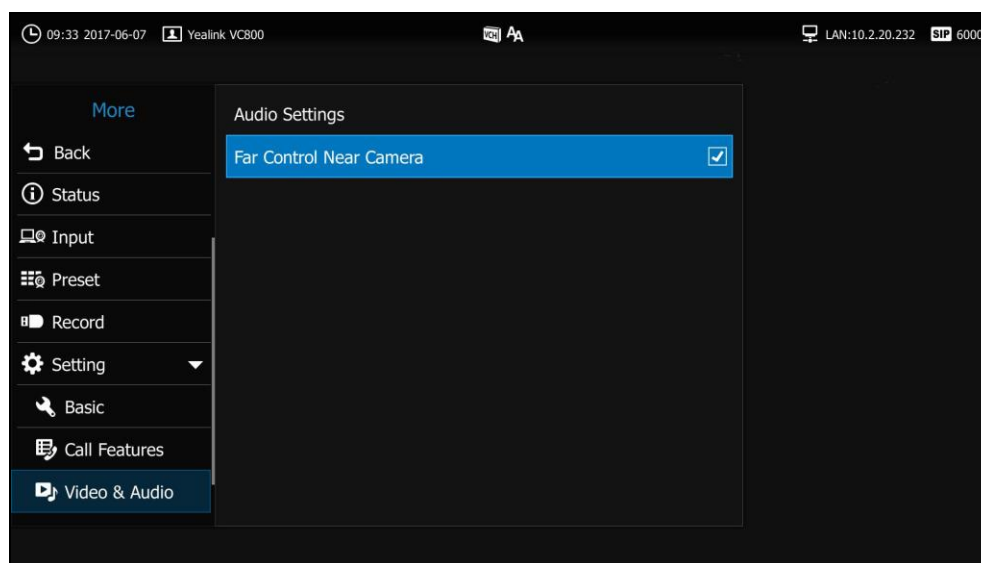









5. Press  to return to the idle screen.

Far-end Camera Control is configurable via web user interface at the path **Setting->Video & Audio->Far Control Near Camera**.

Controlling the Remote Camera



If the remote camera enables the **Far Control Near Camera** feature and corresponding camera control protocol is enabled (For more information, refer to your system administrator), you can control the remote camera during a video call via the remote control.

To control the remote camera during a video call via the remote control:

1. Press  or  to open **Talk Menu**.
2. Press  or  to scroll to **Other** and then press  to expand the menu.
3. Press  or  to scroll to **Near/Far Camera** and then press  to select the remote video.

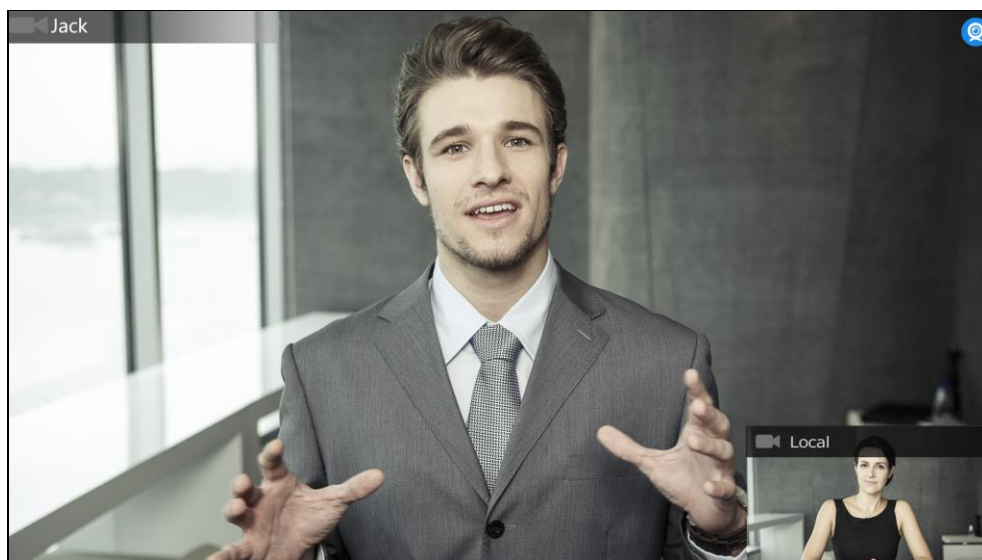
An  icon appears in the remote video image, which indicates control of the remote camera.



4. Press the navigation key to adjust the angle of the remote camera or press  or  to adjust the focus of the remote camera.

Using the VC800 Video Conferencing System

The VC800 video conferencing system can be used to place calls, answer calls, or conduct a conference call. You can switch layout, record videos or capture screenshots during a call.

This chapter provides basic operating instructions for the VC800 video conferencing system.

Topics include:

- [Account Polling](#)
- [Multipoint License](#)
- [Placing Calls](#)
- [Conference Management](#)
- [Meeting Password](#)
- [Joining the Meeting](#)
- [Meeting Whitelist](#)
- [Meeting Blacklist](#)

If you require additional information or assistance with your new phone, contact your system administrator.

Account Polling

When you dial account numbers of other system, account polling feature enables your system to use different call types according to this priority: Cloud platform>H.323 account>SIP account. If you cannot call other systems using all your registered accounts, then this call fails.

Account polling is disabled by default. When you register multiple accounts (2 or more) for your system, you can enable account polling feature. You can configure account polling feature via web user interface only.

To configure account polling via web user interface:

1. Click on **Setting->Call Features**.
2. Select the desired value from the pull-down list of **Account Polling**.
 - If you select **Disabled**, the system can only call other systems using the call type with the highest priority.

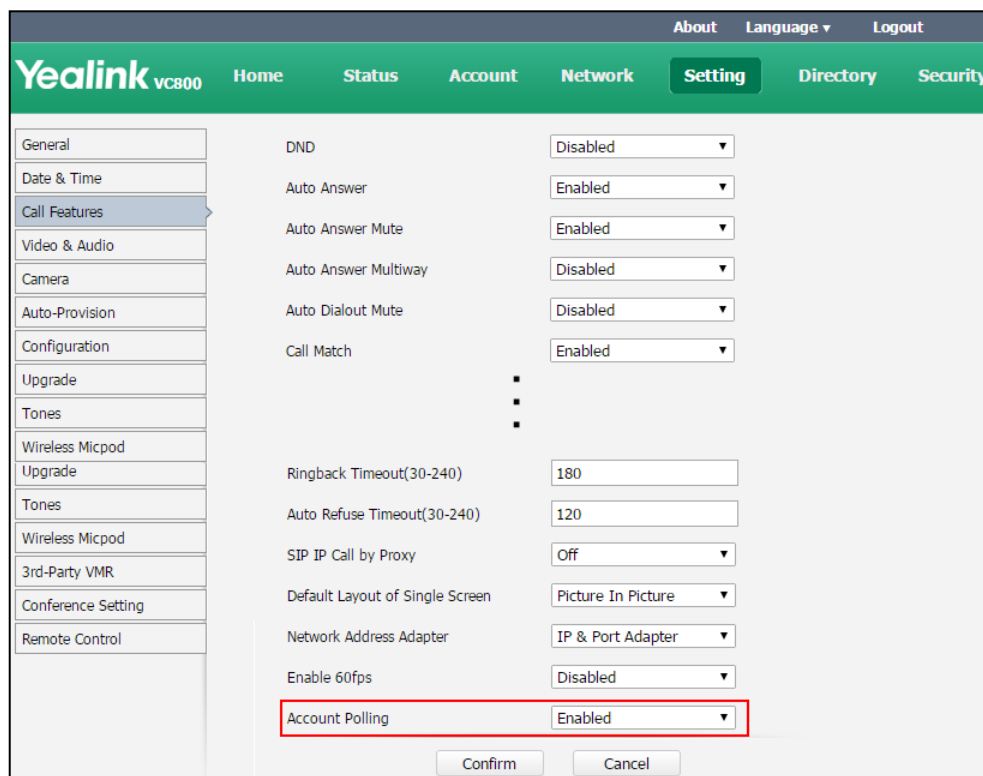

- If you select **Enabled**, the system will attempt to call other system using different call types according the priority.



3. Click **Confirm** to accept the change.

The following example shows the way calls are placed when account polling is enabled or disabled.

Scenario:

1. System A is registered with a Yealink Cloud account and a SIP account.
2. On system A, select  (**Dial** menu) or press  to enter the pre-dialing screen.

3. Select **Auto** from the pull-down list of **Call Type** before calling.

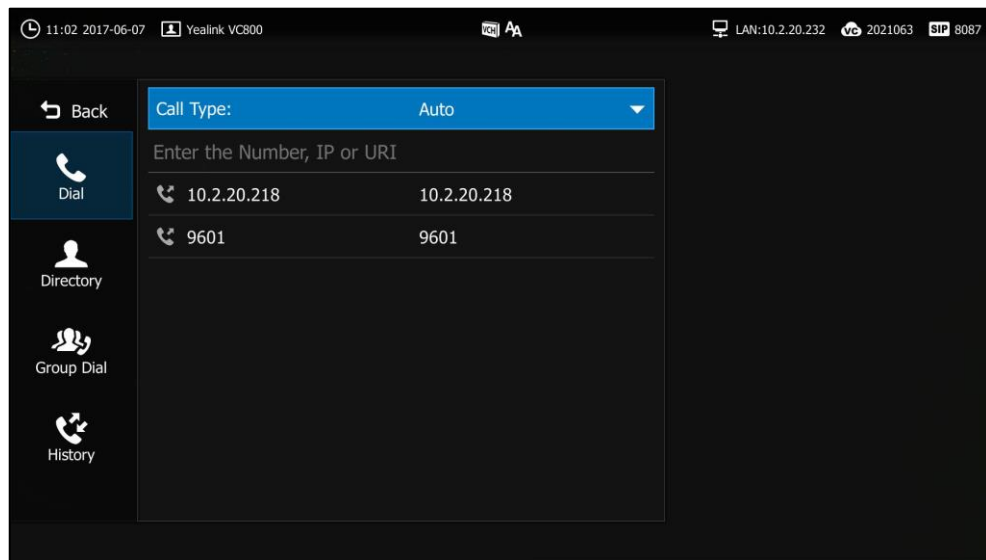

4. On system A, dial the account numbers of system B.

Result:

- If account polling is disabled, system A can only use its Cloud account (highest priority) to call system B.
- If account polling is enabled, system A will use its Cloud account (highest priority) to call system B first. If this call fails, system A continues to use its SIP account (next priority) to call system B.

Multipoint License

You can use your VC800 system to participate in multipoint conferences. Multipoint conferences require a multipoint license. Multipoint license is configurable via web user interface only.

Maximum connections of the multipoint licenses are described as below.

Multipoint License Type	Maximum Connections	Description
Without a multipoint license	One video call with a presentation and a voice call (a conference moderator and 2 participants).	Multipoint conferences are unsupported.
Trial multipoint license	24 ways video call with a presentation (a conference moderator and 24 participants).	Period of validity: 15-day free trial VC800 models can use this trial multipoint license. You can download it from Yealink website.
8 ways multipoint	8 ways video call with a presentation (a conference	Period of validity: Eternal

Multipoint License Type	Maximum Connections	Description
license	moderator and 8 participants).	You need to contact Yealink resellers to purchase it, please provide the MAC address of your VC800 when purchasing.
16 ways multipoint license	16 ways video call with a presentation (a conference moderator and 16 participants).	
24 ways multipoint license	24 ways video call with a presentation (a conference moderator and 24 participants).	

To import the multipoint license via web user interface:

1. Click on **Security**->**License**.
2. Click **Browse** to locate the multipoint license (the file format must be *.dat) from your local system.

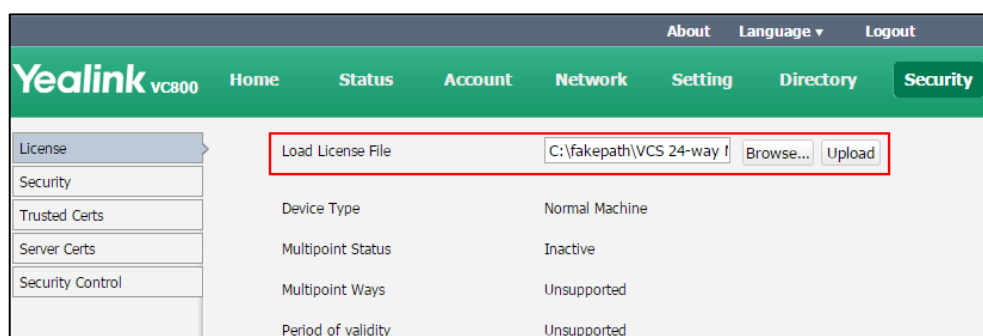

3. Click **Upload** to complete importing the multipoint license.

To view multipoint license status via the remote control:

1. Select  (**More** menu).
2. Press  or  to scroll to **Status** and then press  to enter submenu.

3. Press ▲ or ▼ to scroll to **License** and then press (OK) .

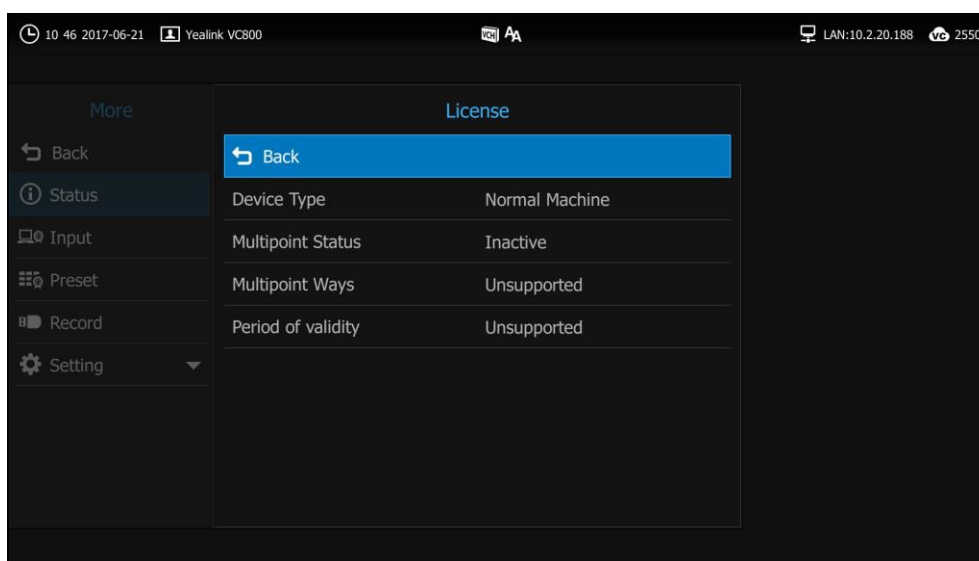

Parameter	Description
Device Type	Indicates that the VC800 system is a DEMO machine or a normal machine.
Multipoint Status	Indicates whether a multipoint license has been imported to the VC800 system or not. <ul style="list-style-type: none"> Active Inactive (without a multipoint license or the imported multipoint license has expired)
Multipoint Ways	Indicates the multipoint license imported to the VC800 system. <ul style="list-style-type: none"> Unsupported 8 Ways 16 Ways 24 Ways
Period of validity	Indicates the validity period of the imported multipoint license. <ul style="list-style-type: none"> Unsupported X~Y Available Eternal

To view multipoint license status via the CP960 conference phone:

1. Tap  -> **License**.

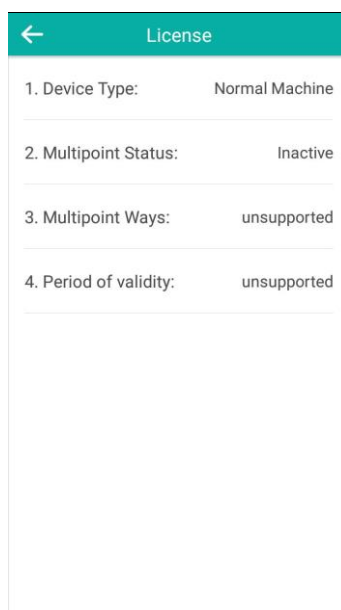

Multipoint license status can be viewed via web user interface at the path **Status->License**.

Note

Upgrading the system or performing a factory reset will not affect the imported multipoint license.

If the system has been imported a trial multipoint license and the license has not expired, and you import a permanent multipoint license to the system, the permanent multipoint license will overwrite the trial multipoint license.

If the system has been imported a permanent multipoint license, and you import a trial multipoint license to the system, the permanent multipoint license will not be overwritten.

If you import a new permanent multipoint license to the system, the previous permanent multipoint license will be overwritten.

Placing Calls

You can place a call in three ways using your VC800 video conferencing system:

- Using the remote control
- Using the CP960 conference phone
- Via web user interface

The VC800 video conferencing system supports two call modes:

- Voice Call

- Video Call

Note

The system supports placing calls using contact numbers, SIP URI, IP address, H. 323 account or extension. SIP URI and IP addresses can be up to 32 characters. For example: SIP URI:2210@sip.com, IP: 192.168.1.15.
For more information, contact your system administrator.



You can search and dial a contact from the call history or local directory. For more information, refer to [Directory](#) on page 63 and [Call History Management](#) on page 77.





If the system fails to call, you can troubleshoot the problems according to the following prompts:

Prompts	Description
Call Failed Busy Here	<ul style="list-style-type: none"> • Remote system rejects your SIP call. • Remote system does not answer your SIP call. • Remote system has reached maximum sessions when you place a SIP call.
Call Failed Remote endpoint refused call	<ul style="list-style-type: none"> • Remote system rejects your H.323 call • Remote system does not answer your H.323 call. • Remote system has reached maximum sessions when you place an H.323 call.
Network disconnected	Local network is disconnected.
Maximum number of sessions reached	Local system has reached maximum sessions.

Placing a Call Using the Remote Control

To place a call using the remote control:

1. Select  (**Dial** menu) or press  to enter the pre-dialing screen.
2. Select the desired account type from the pull-down list of **Call Type** before calling.
If you select **Auto**, the system will select the desired account type according to the priority.
If you dial an account, the priority is: **Cloud platform**>**H.323 account**>**SIP account**. For more information, refer to [Account Polling](#) on page 91.
If you dial an IP address, the priority is: **H.323 IP Call**>**SIP IP Call**.
3. Enter the desired number using the keypad or the on-screen keyboard.
You can also select the desired record from the recent call history.

4. Press  to select  (video call) or  (voice call), and then press  .

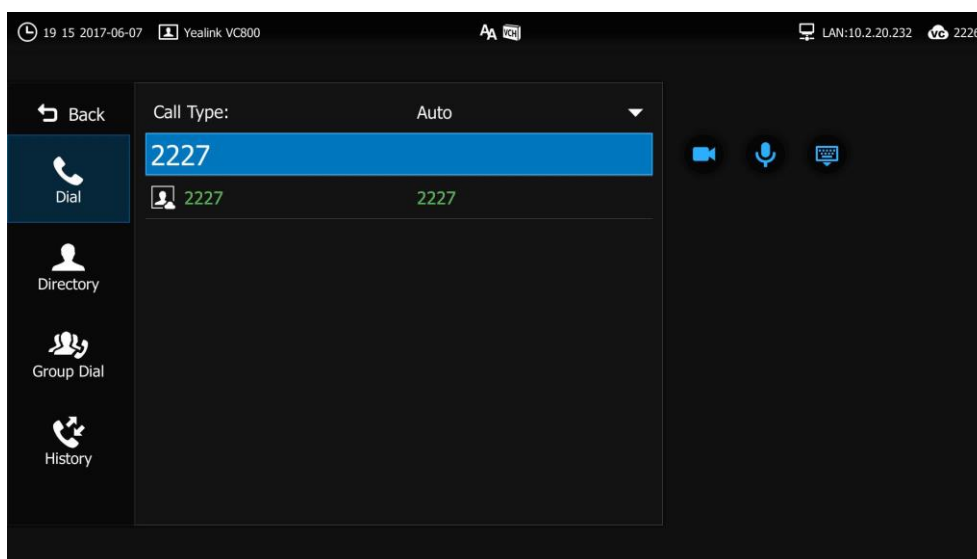

Placing a Call Using the CP960 conference phone

To place a call using the CP960 conference phone:

1. Tap  .
2. Tap the **Auto** field.
3. Tap the desired account type in the pop-up dialog box.

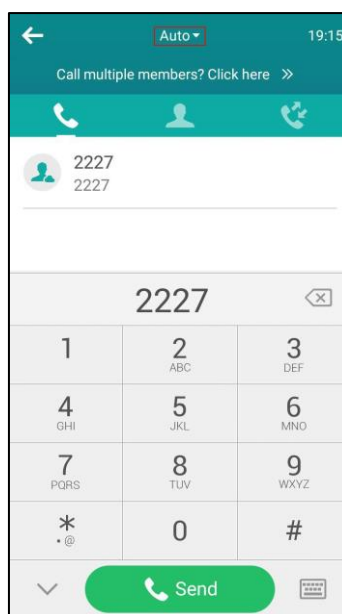

4. Enter the desired number using the keypad.
5. Tap **Send**.

Placing a Call via Web User Interface

To place a call via web user interface:

1. Click **Home**.
2. Enter the desired number in the **Enter Number** field.
3. (Optional.) Select the desired account type.
4. (Optional.) Select the desired bandwidth.
If you select **Auto**, the system will select the appropriate bandwidth automatically.
5. Click **Video Call** or **Voice Call**.

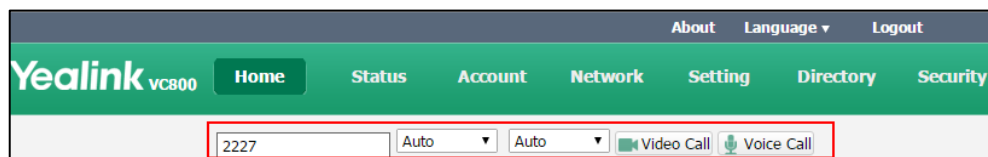







Initiating a Conference

With a multipoint license, you can initiate a conference by dialing a group or inviting participants during a call.

You can initiate a conference via the remote control, CP960 conference phone or web user interface.

Initiating a Conference by Dialing a Group

To dial a group via the remote control:

1. Select  (**Dial** menu) or press  to enter the pre-dialing screen.
2. Press  to return to the menu.
3. Press  or  to scroll to **Group Dial** and then press  to enter submenu.
4. Select the desired contacts you want to call.

The number of contacts in the group depends on the imported multipoint license.

For example, if you import a 24 ways license to your VC800 system, you can select up to 24 contacts. For more information on multipoint license, refer to [Multipoint License](#) on page 93.

5. Press  to enter submenu

6. Select **Start conference call**, and then press  .

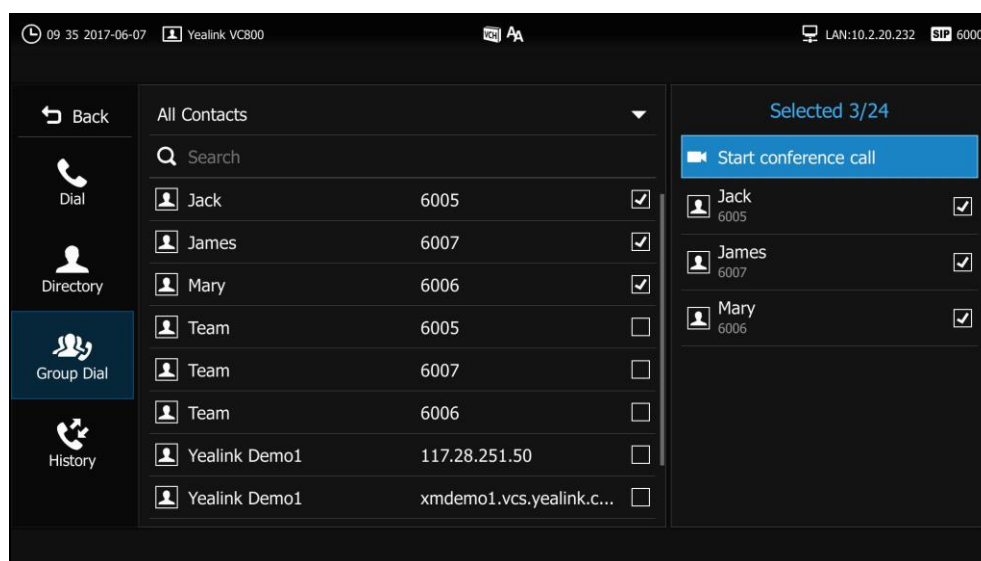

To dial a group via the CP960 conference phone:

1. Tap  .
2. Tap the **Call multiple members? Click here** field.

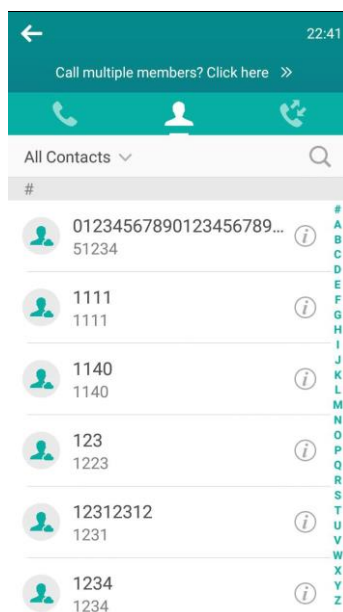

3. Tap the desired contacts you want to call.





The number of contacts in the group depends on the imported multipoint license.

For example, if you import a 24 ways license to your VC800 system, you can select up to 24 contacts. For more information on multipoint license, refer to [Multipoint License](#) on page 93.

4. Tap  .

Initiating a Conference by Inviting Participants

To invite participants during a call via the remote control:

1. Using your preferred dialing method, call the first site.
2. Press  or  to open **Talk Menu**.
3. Press  or  to scroll to **New Call** and then press  to expand the menu.
4. Do one of the following:

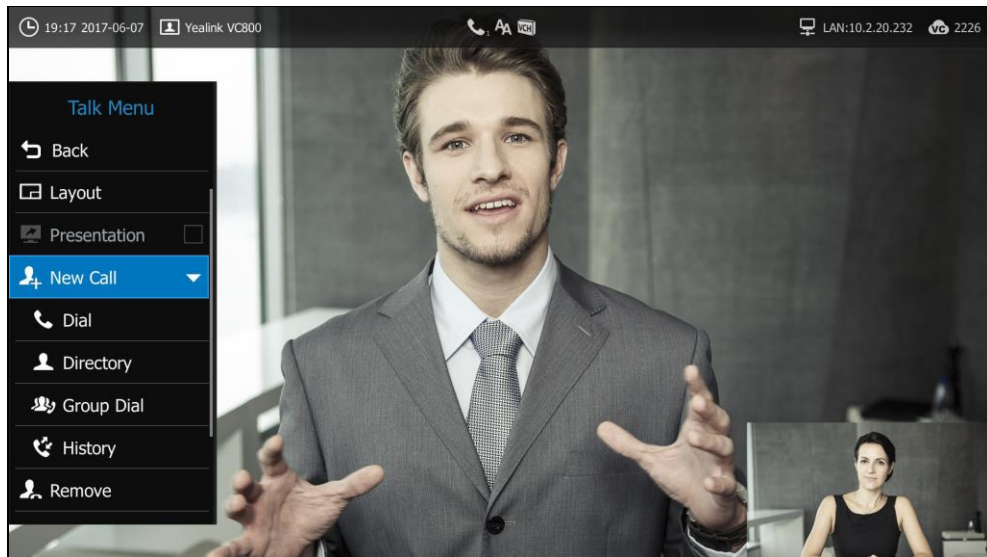

- If you select **Dial**, enter a phone number, and then dial out.
 - If you select **Directory**, select a desired contact, and then dial out.
 - If you select **Group Dial**, check the desired contacts' checkboxes, and then select **Start conference call**.
 - If you select **History**, select the desired history record, and then dial out.
5. Repeat the above steps until all participants have been added.

Note

You can press  to enter the pre-dialing screen during a call.





If you try to invite a new party when the maximum number has been reached, the system will prompt "Talking Session over max Session number!".

To invite participants during a call via the CP960 conference phone:

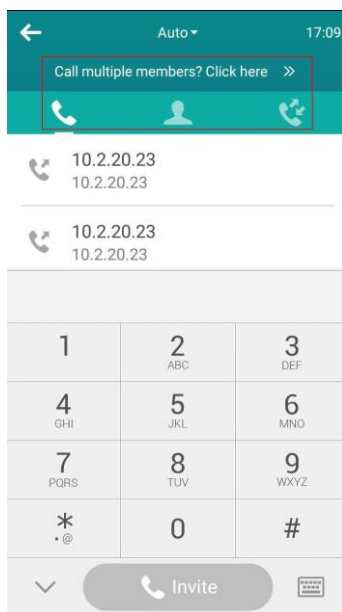
1. Using your preferred dialing method, call the first site.
2. Tap  .

3. Do one of the following:



- If you tap , enter a phone number and then tap **Invite**.
- If you tap , tap a desired contact to dial out.
- If you tap , tap the desired history record to dial out.
- If you tap **Call multiple members? Click here**, tap the desired contacts you want to call, and then tap .

4. Repeat steps 2 to 3 until all participants have been added.

Invite participants via web user interface at the path **Home**.

Conference Management

Conference Type

The VC800 video conferencing conference can host a **Regular Mode** conference or a **VMR Mode** conference.

Regular Mode Conference

In **Regular Mode** conference, the moderator can communicate with other participants.

To configure regular mode conference via web user interface:

1. Click on **Setting**->**Conference Setting**.
2. Select **Regular Mode** from the pull-down list of **Conference Type**.

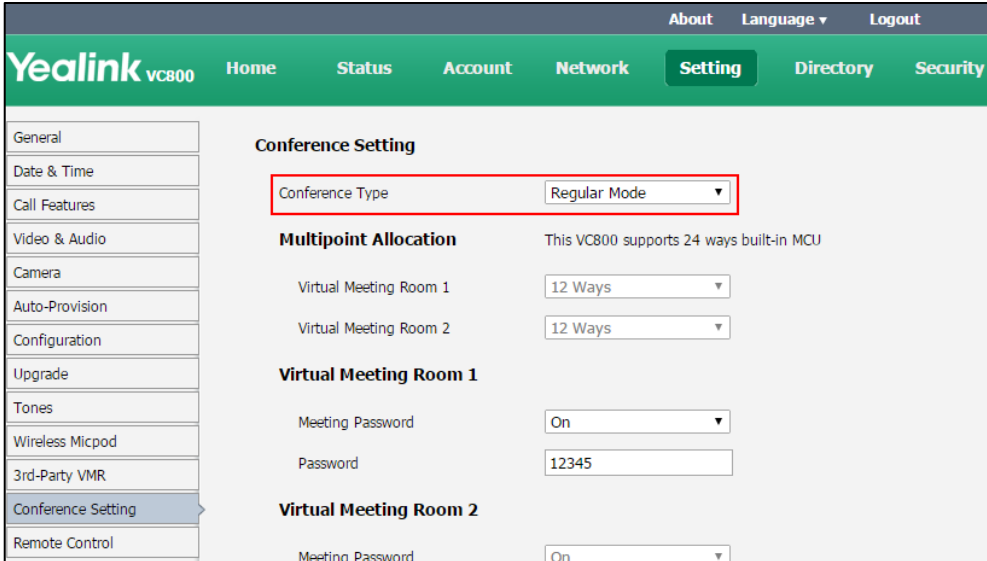

The screenshot shows the Yealink VC800 web interface. The top navigation bar includes 'About', 'Language', and 'Logout'. The main menu has 'Home', 'Status', 'Account', 'Network', 'Setting' (highlighted), 'Directory', and 'Security'. On the left, a sidebar lists various settings categories, with 'Conference Setting' selected. The main content area is titled 'Conference Setting' and contains the following configuration options:

- Conference Type:** A dropdown menu set to 'Regular Mode', highlighted with a red box.
- Multipoint Allocation:** A note states 'This VC800 supports 24 ways built-in MCU'. Below it, 'Virtual Meeting Room 1' and 'Virtual Meeting Room 2' are each set to '12 Ways' via dropdown menus.
- Virtual Meeting Room 1:**
 - Meeting Password: 'On' (dropdown)
 - Password: '12345' (text input)
- Virtual Meeting Room 2:**
 - Meeting Password: 'On' (dropdown)

3. Click **Confirm** to accept the change.

The number of participants depends on the multipoint license you imported. The maximum value can be 8, 16 or 24. For more information on multipoint license, refer to [Multipoint License](#) on page 93.

For more information on how to join a regular mode conference, refer to [Note Joining the Meeting](#) on page 106.

VMR Mode Conference

In VMR mode conference, the MCU of moderator can be used to host two independent conferences (corresponding to virtual meeting room 1 and virtual meeting room 2).

- Virtual meeting room 1: the moderator can communicate with other participants.

- Virtual meeting room 2: the moderator does not join this meeting and only provides MCU resource for the participants.

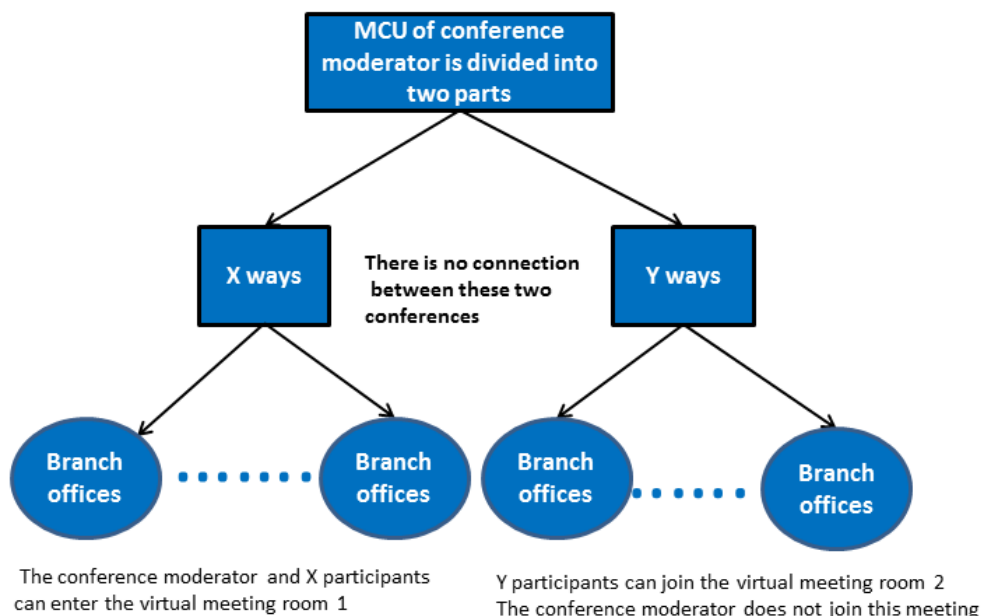

If you import a multipoint license to the VC800 system, you can allocate the MCU ways between two virtual meeting rooms.

- If you import an 8 ways multipoint license, $X+Y \leq 8$.
Two virtual meeting rooms support up to 8 ways video calls.
- If you import a 16 ways multipoint license, $X+Y \leq 16$.
Two virtual meeting rooms support up to 16 ways video calls.
- If you import a 24 ways multipoint license, $X+Y \leq 24$.
Two virtual meeting rooms support up to 24 ways video calls.

To configure VMR mode conference via web user interface:

- Click on **Setting**->**Conference Setting**.
- Select **VMR Mode** from the pull-down list of **Conference Type**.
- Select the MCU ways from the pull-down list of **Virtual Meeting Room 1**.
For example, if you select 12, a moderator and 12 participants can join the virtual meeting room 1 at most.
- Select the MCU ways from the pull-down list of **Virtual Meeting Room 2**.

For example, if you select 12, the moderator does not join this meeting, 12 participants can join the virtual meeting room 2 at most.

The screenshot shows the Yealink VC800 web interface. The top navigation bar includes 'About', 'Language', and 'Logout'. The main menu has 'Home', 'Status', 'Account', 'Network', 'Setting' (highlighted), 'Directory', and 'Security'. On the left, a sidebar lists various settings categories, with 'Conference Setting' selected. The main content area is titled 'Conference Setting' and contains the following configuration options:

- Conference Type:** VMR Mode (dropdown menu)
- Multipoint Allocation:** This VC800 supports 24 ways built-in MCU.
 - Virtual Meeting Room 1: 12 Ways (dropdown menu)
 - Virtual Meeting Room 2: 12 Ways (dropdown menu)
- Virtual Meeting Room 1:**
 - Meeting Password: Off (dropdown menu)
 - Password: (text input field)
- Virtual Meeting Room 2:**
 - Meeting Password: Off (dropdown menu)

By default, the MCU ways are distributed equally between two virtual meeting rooms.

5. Click **Confirm** to accept the change.

For more information on how to join a VMR mode conference, refer to [Joining the Meeting](#) on page 106.

Meeting Password

Depending on how a conference call is set up, you might be required to enter a meeting password to join the call. You can also require far-end systems to enter a meeting password to prevent unauthorized participants from joining conference calls hosted by your system.

If you host a regular mode conference, you need to configure password for virtual meeting room 1. If you host a VMR mode conference, you need to configure passwords for virtual meeting room 1 and virtual meeting room 2.

To set up a meeting password via web user interface:

1. Click on **Setting**->**Conference Setting**.
2. Select **On** from the pull-down list of **Meeting Password**.

- Enter meeting password in the **Password** field.

The screenshot shows the Yealink VC800 web interface with the 'Setting' tab selected. The 'Conference Setting' page is displayed. The 'Virtual Meeting Room 1' and 'Virtual Meeting Room 2' sections are highlighted with a red box. In the 'Virtual Meeting Room 1' section, the 'Meeting Password' is set to 'On' and the 'Password' field contains '12345'. In the 'Virtual Meeting Room 2' section, the 'Meeting Password' is set to 'On' and the 'Password' field contains '54321'.

- Click **Confirm** to accept the change.

Note

You can add specified users to the meeting whitelist. Users in the whitelist can dial your virtual meeting room 1 directly without meeting password. But users in the whitelist still need meeting password to enter the virtual meeting room 2. For more information on meeting whitelist, refer to [Meeting Whitelist](#) on page 106.

Joining the Meeting

Participants can dial **IP##meeting password** or **meeting password@IP** to enter the virtual meeting room.

For example:

- The IP address of moderator is 10.3.6.201.
- 123 is meeting password for virtual meeting room 1.
- 456 is meeting password for virtual meeting room 2.

Participants can dial **10.3.6.201##123** or **123@10.3.6.201** to enter the virtual meeting room 1.

Participants can dial **10.3.6.201##456** or **456@10.3.6.201** to enter the virtual meeting room 2.

Without a meeting password or with a wrong meeting password, the call will fail.

Meeting Whitelist

You can add the IP address, account or domain name of the remote system to the meeting

whitelist. Users in the whitelist can join your conference call directly without meeting password even if you have enabled the meeting password feature. VC800 video conferencing system supports up to 100 whitelist records. Meeting whitelist is configurable via web user interface only.

To add the meeting whitelist numbers via web user interface:

1. Click on **Directory**->**Meeting Whitelist**.
2. Enter the user's IP, account or domain name in the **Meeting Whitelist Number** field.

The screenshot shows the Yealink VC800 web interface. The navigation menu includes 'Home', 'Status', 'Account', 'Network', 'Setting', 'Directory', and 'Security'. The 'Directory' menu is expanded, showing options like 'Local Directory', 'History', 'LDAP', 'Meeting Whitelist', 'Meeting Blacklist', and 'Setting'. The 'Meeting Whitelist' option is selected. In the main content area, there is a table with two columns: 'Meeting Whitelist Number' and 'Operation'. The 'Meeting Whitelist Number' column contains the IP address '10.2.5.36'. The 'Operation' column contains a '+ Add' button, which is highlighted with a red box.

3. Click **Add**.
4. Repeat step 2-3 to add more numbers to the meeting whitelist.

Note

Users in the whitelist can join virtual meeting room 1 without a password. If moderator hosts a VMR mode conference, users in the whitelist still need password to join virtual meeting room 2.

To delete the meeting whitelist numbers via web user interface:

1. Click on **Directory**->**Meeting Whitelist**.
2. Click **Delete** beside the numbers that you want to delete.

The screenshot shows the Yealink VC800 web interface. The navigation menu includes 'Home', 'Status', 'Account', 'Network', 'Setting', 'Directory', and 'Security'. The 'Directory' menu is expanded, showing options like 'Local Directory', 'History', 'LDAP', 'Meeting Whitelist', 'Meeting Blacklist', and 'Setting'. The 'Meeting Whitelist' option is selected. In the main content area, there is a table with two columns: 'Meeting Whitelist Number' and 'Operation'. The 'Meeting Whitelist Number' column contains the IP address '10.2.5.36'. The 'Operation' column contains a '- Delete' button, which is highlighted with a red box.

The web user interface prompts the message "Warning: Are you sure delete the white number?".

3. Click **Confirm**.

Meeting Blacklist

You can add the IP address, account or domain name of the remote system to the meeting

blacklist. VC800 will refuse incoming calls from the blacklist automatically. If the user is in both meeting whitelist and meeting blacklist, the blacklist has higher priority. VC800 will still refuse incoming calls from this user. VC800 will not remind incoming calls and save call history from blacklist.

VC800 supports up to 100 blacklist records. Blacklist is configurable via web user interface only.

To add the blacklist numbers via web user interface:

1. Click on **Directory**-> **Meeting Blacklist**.
2. Enter the user's IP address, account or domain name in the **Meeting Blacklist Number** field.

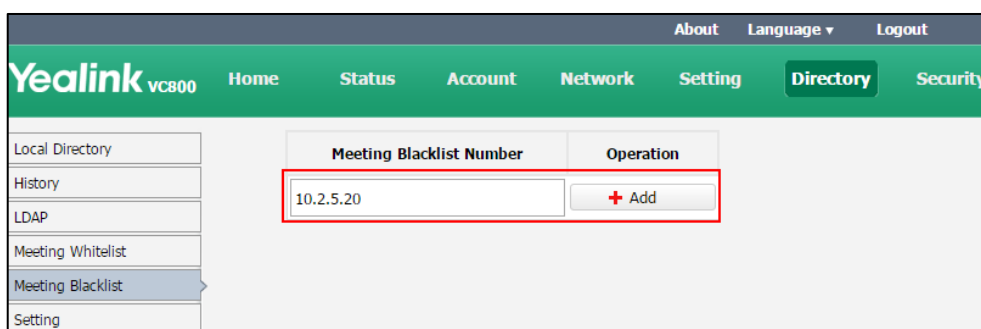

3. Click **Add**.
4. Repeat step 2-3 to add more numbers to the meeting blacklist.

To delete the blacklist numbers via web user interface:

1. Click on **Directory**->**Meeting Blacklist**.
2. Click **Delete** beside the numbers that you want to delete.

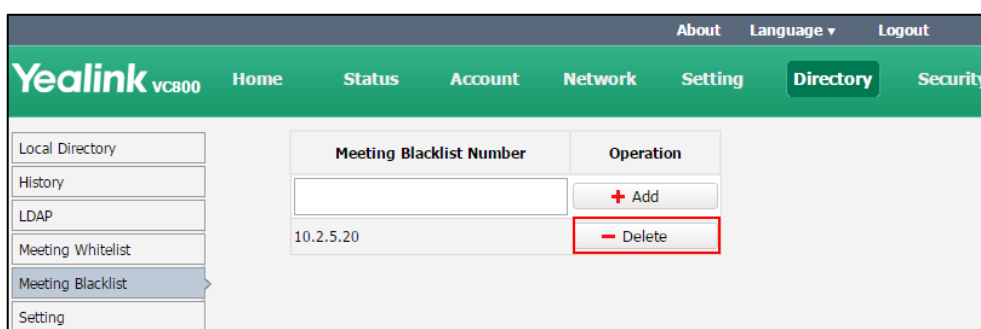









The web user interface prompts the message "Warning: Are you sure delete the black number?".

3. Click **Confirm**.

Editing Number before Calling

You can edit numbers before calling when the VC800 video conferencing system is on the pre-dialing screen.

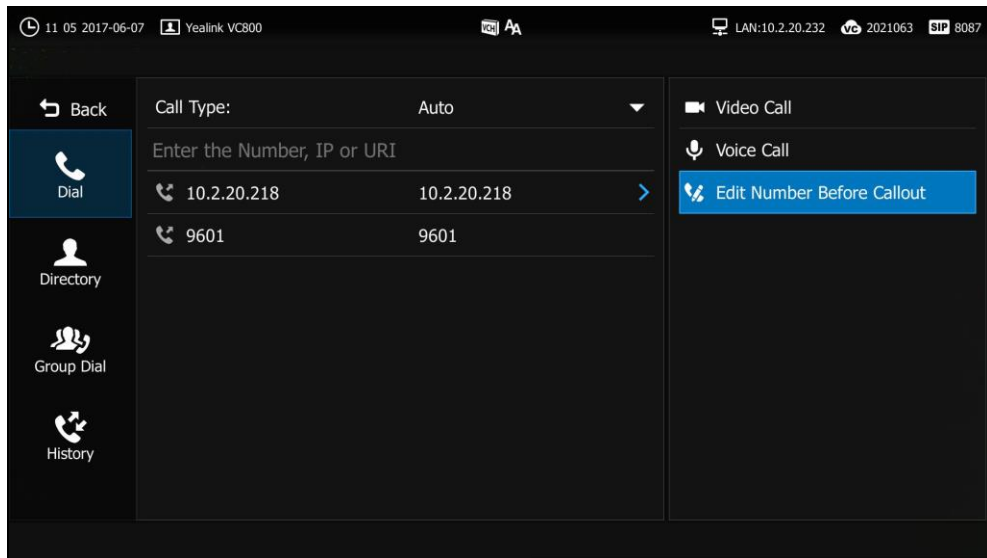

To edit number before calling via the remote control:

1. Select  (**Dial** menu) or press  to enter the pre-dialing screen.
2. Press  or  to scroll to the desired history record and then press  to open submenu.
3. Press  or  to scroll to **Edit Number Before Callout** and then press .



4. Edit numbers using the keypad or the on-screen keyboard, and then dial out.

To edit number before calling via the CP960 conference phone:

1. Tap  .
The touch screen displays all call records.
2. Tap  after the desired call records.
3. Tap **Edit before calling**.

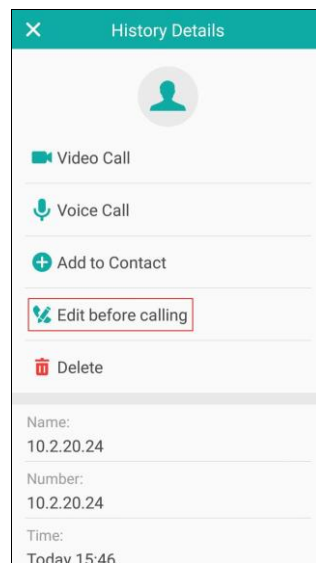

4. Edit the number and tap **Send**.

Answering or Rejecting Calls

When the system is receiving a call, you can answer or reject the call in the following ways:

- Using the remote control
- Using the CP960 conference phone

If the system accepts multiple calls, a conference call will be established.



To answer a call:

Do one of the following:

- Press  on the remote control.
- Tap **Answer** on the CP960 conference phone.

To reject a call:

Do one of the following:

- Press  or select **Reject** first, and then press  on the remote control.
- Tap **Reject** on the CP960 conference phone.

Auto Answer







You can enable the auto answer feature for the system to automatically answer the first incoming call.



Auto answer features you need to know:

Parameters	Description
Auto Answer	Enables or disables the system to automatically answer the incoming point-to-point call.
Auto Answer Mute	Enables or disables the system to be muted when a call connects. This feature can be enabled only when the auto answer feature is enabled.
Auto Answer Multiway	Enables or disables the system to automatically answer the incoming multipoint call. This feature is available only when the auto answer is enabled.

Auto answer is configurable via the remote control or web user interface.

To configure auto answer via the remote control:

1. Select  (**More** menu).
2. Press  or  to scroll to **Setting** and then press  to expand the menu.
3. Press  or  to scroll to **Call Features** and then press  to enter submenu.

4. Press ▲ or ▼ to scroll to **Auto Answer**, and then press  to enable or disable this feature.
5. Press ▲ or ▼ to scroll to **Auto Answer Mute**, and then press  to enable or disable this feature.
6. Press ▲ or ▼ to scroll to **Auto Answer Multiway**, and then press  to enable or disable this feature.

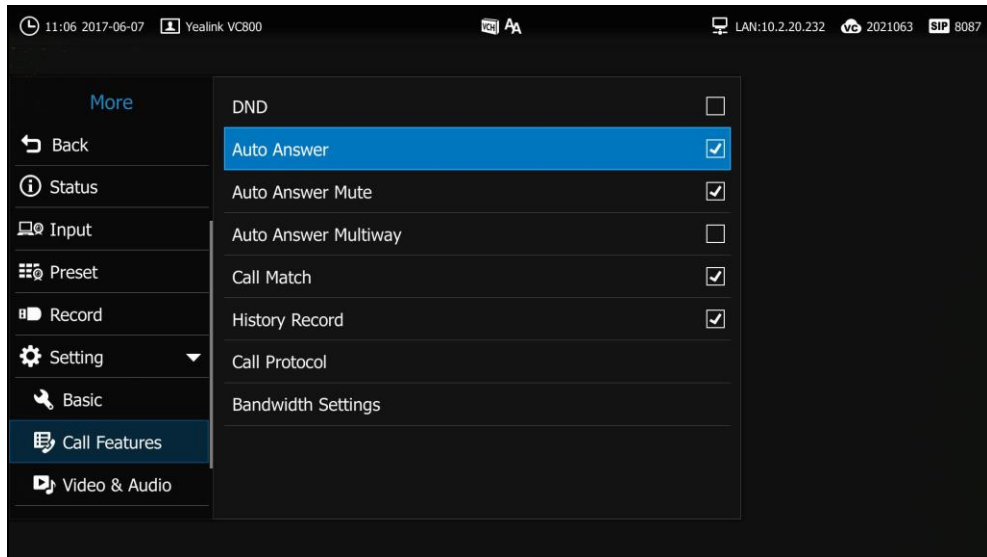



7. Press  to return to the idle screen.

If the auto answer feature is enabled, the  icon will appear on the status bar of the display device.

To configure auto answer via the CP960 conference phone:

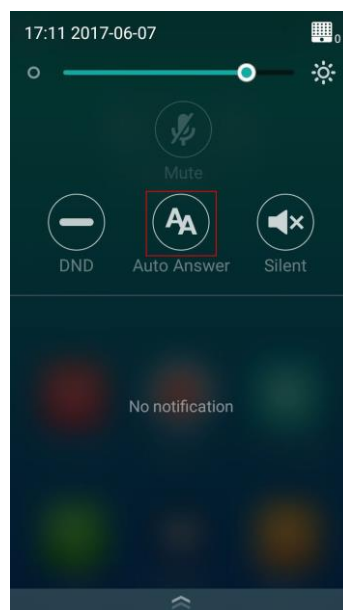
1. Swipe down from the top of the screen.
2. Tap  to enable or disable auto answer.



If the auto answer feature is enabled, the  icon will appear on the status bar of the touch screen.











Auto answer is configurable via web user interface at the path **Setting-> Call Features->Auto Answer/Auto Answer Mute/Auto Answer Multiway**.

Do Not Disturb (DND)



You can use DND to reject incoming calls automatically on the system. Callers will receive a busy message.

You can enable/disable DND for the system via the remote control, CP960 conference phone or web user interface. You can also enable DND for the system to reject incoming call automatically during an active call.

To enable the DND mode via the remote control:

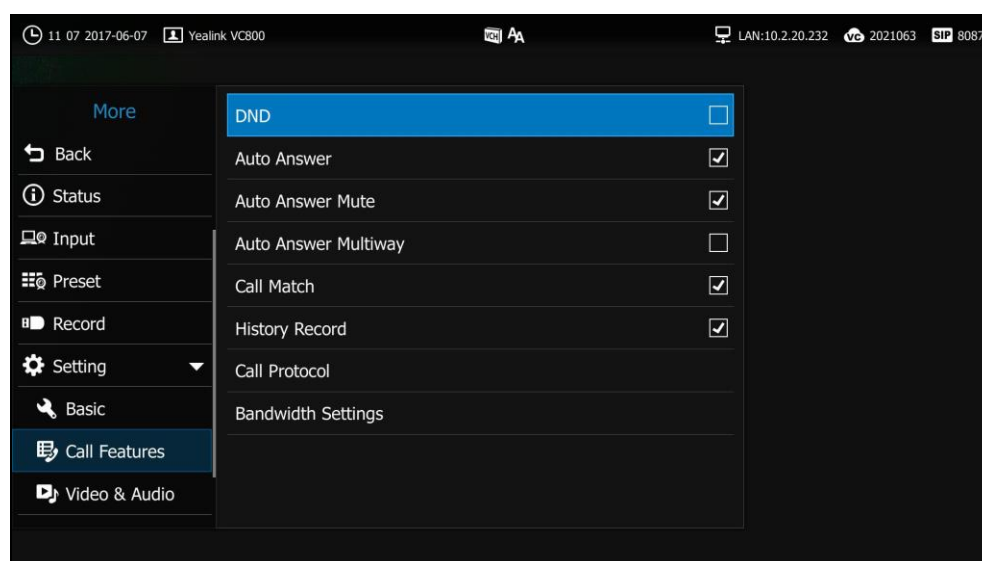
1. Select  (**More** menu).
2. Press  or  to scroll to **Setting** and then press  to expand the menu.
3. Press  or  to scroll to **Call Features** and then press  to enter submenu.
4. Press  or  to scroll to **DND**, and then press  to enable or disable this feature.



5. Press  to return to the idle screen.
The  icon will appear on the status bar of display device, and "Do not disturb now!" will be prompted at intervals.

The system will reject all incoming calls automatically, and the icon and numbers of missed calls are displayed on the status bar of the display device. If the system places a call, after the call is established, the DND mode will be disabled automatically.

To enable the DND mode via the CP960 conference phone:

1. Swipe down from the top of the screen.

2. Tap  to enable DND.

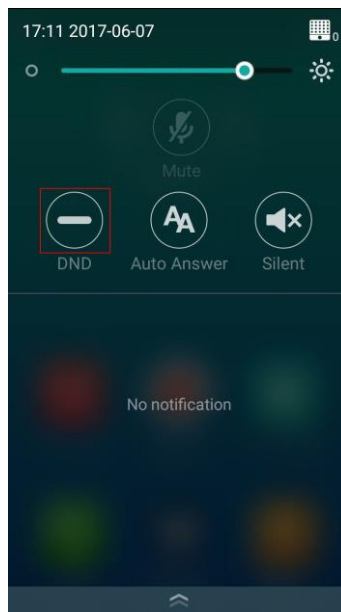

If the DND feature is enabled, the touch screen prompts “  DND mode is enabled”.

To disable the DND mode via the CP960 conference phone:

1. Do one of the following:
 - Swipe down from the top of the screen.
 - Tap  to disable DND.
 - When the CP960 is idle, tap **Exit DND mode** to disable DND.

DND is configurable via web user interface at the path **Setting->Call Features->DND**.

DND during an active call

You can use the DND mode to reject incoming calls automatically during an active call.

You can enable/disable the DND mode for the system via the remote control, CP960 conference phone or web user interface. The DND mode will be disabled after the call ends.

To enable the DND mode during an active call via the remote control:

1. Press  or  to open **Talk Menu**.

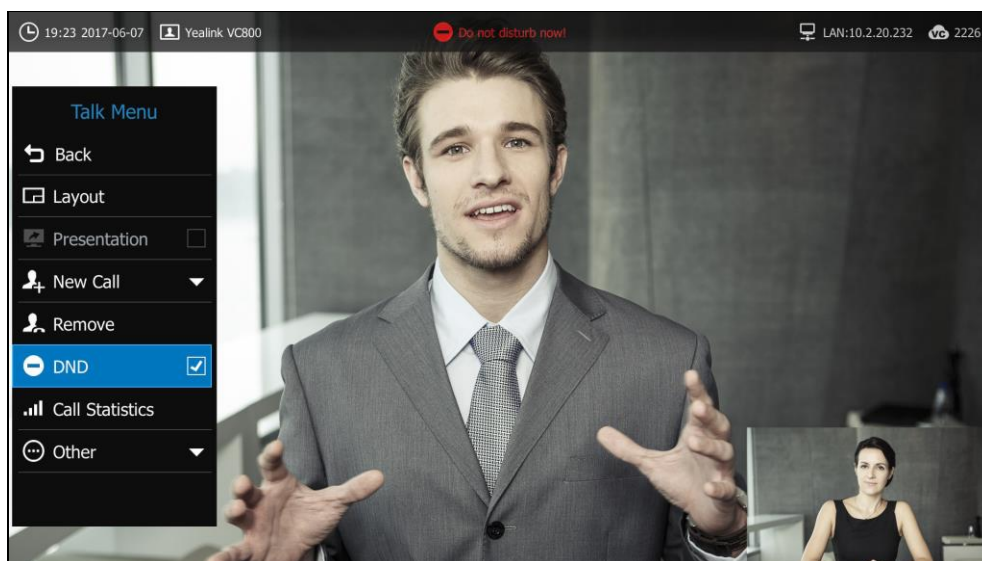

2. Press ▲ or ▼ to scroll to **DND** and then press  .



The  icon will appear on the status bar of display device, and “Do not disturb now!” will be prompted at intervals.

3. Press  to return.

To enable or disable the DND mode during an active call via the CP960 conference phone:

1. Tap  during a call to enable DND.
The  icon will appear on the status bar of touch screen.
2. Tap  during a call to disable DND.



DND during an active all feature is configurable via web user interface at the path **Home->DND**.

Ending Calls

During a two-way call, do one of the following to end the call.

- Press  on the remote control.
- Tap **EndCall** on the CP960 conference phone.
- Click **Hang Up All** button on the web user interface.
The interface prompts “Hang up?”
Click **Confirm** to end the call.

During a multi-way call, do one of the following to end the call.

- Press  on the remote control.
The display device prompts “End all active calls?”
Select **OK**, and then press .
- Tap **EndCall** on the CP960 conference phone.

The CP960's touch screen prompts "End all active calls?"

Tap **OK** to end all calls.





- Click **Hang Up All** button on the web user interface.

The interface prompts "Hang up?"

Click **Confirm** to end the call.

During a multi-way call, you can remove any party via the remote control, CP960 conference phone or web user interface.

To remove any party via the remote control:

1. Press  or  to open **Talk Menu**.
2. Press  or  to scroll to **Remove** and then press  to enter submenu.

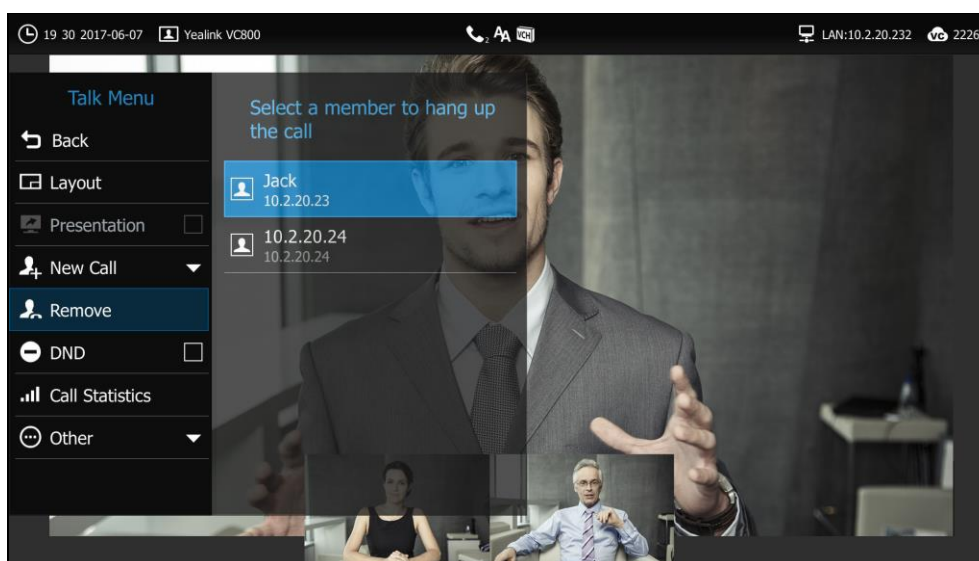



3. Select the party you want to remove, and then press .

To remove any party via the CP960 conference phone:

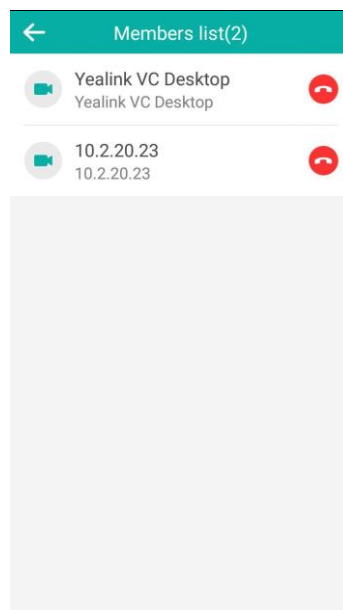
1. Tap  -> .



2. Tap  after the desired party to remove.

To remove any party from a multi-way call via web user interface, go to the path **Home** (Hover your cursor over of the number of remote system, and then click ).

Call Management





You can enable mute mode, record video, control the video and change video layout during an active call.

Call Mute

You can enable mute mode to mute the microphone of the active audio device during an active call, and then the other party cannot hear you.

To mute a call during a call:

Do one of the following:

- Press  on the remote control.
- Tap  on the CP960 conference phone to mute the call.
- Tap  on the CP960's touch screen to mute the call.
- Tap  on the CPW90 wireless expansion mic to mute the call.
- Tap  on the CPE90 wired expansion mic to mute the call.

- Log into the web user interface, check the **Mute** checkbox.

If video conferencing system is muted, the  icon will appear on the local video.

Network Quality Tip

During a call, if the packet loss that you receive is more than 5%, the device display will prompt "high packet loss rate".

This tip disappears after 3 seconds. Please check your network, and make sure your network meets the requirements.







Call Statistics

If voice quality is poor during a call, you can enter the Call Statistics screen to view the current status of the call to find out why.

Codec, bandwidth, total packet lost and other parameters about presentation are included in the call statistics. For example, when a delay occurs or the video has a 'mosaic' look, you can view the total packet loss to check whether the packet has been lost.

Call statistics is configurable via the remote control, CP960 conference phone or web user interface.

To view call statistics via the remote control:

1. Press  or  to open **Talk Menu**.
2. Press  or  to scroll to **Call Statistics** and then press .
3. Press  or  to view call statistics for every participant.



Type	Total Bandwidth	Recv (130 kb/s)	Send (215 kb/s)
Video	Resolution	640 x 360	352 x 288
	Codec	H264HP	H264HP
	Bandwidth	82 kb/s	167 kb/s
	Frame Rate	2 fps	30 fps
	Jitter	51 ms	0 ms
	Total Packet Lost	0	0
Audio	Codec	G7221C	G7221C
	Bandwidth	48 kb/s	48 kb/s
	Sample Rate	32 k	32 k
	Jitter	0 ms	0 ms
	Total Packet Lost	0	0
	Packet Lost(%)	0%	0%
Share	Resolution	--	--
	Codec	--	--
	Bandwidth	--	--
	Frame Rate	--	--

Protocol: H323
Total Talk Number: 2

Device Info: Yealink VCDesktop 1.23.0.15 38/2
Total Bandwidth: Recv (185 kb/s), Send (1852 kb/s)

4. Press  to return.

To view call statistics via the CP960 conference phone:

1. Tap  ->  during a call.
The touch screen displays all participants.
2. Tap the desired participant to view call statistics.

Statistics	
Recieved	Send
159 kb/s	343 kb/s
video	
Resolution	640 x 360
Codec	H264HP
Bandwidth	111 kb/s
Frame rate	2 fps
Jitter	51 ms
Total packet lost	0
Packet lost	0%
Audio	
Codec	G7221C
Bandwidth	48 kb/s
Sample rate	32 k
Jitter	5 ms
Total packet lost	0
Packet lost	0 %
Share	
Resolution	-

To view call statistics via web user interface, go to the path **Home** (Hover your cursor over the other party on the left side of the screen, and then click ).

Changing the Video Input Source





VC800 video conferencing system supports these video input sources: camera and PC.

You need to connect a PC to the VCH50 video conferencing hub for sharing contents. When the VC800 system is idle, the display device displays PC content by default.

If two display devices are connected to the VC800 codec, local video image is shown on the main display device, and the PC content is shown on the secondary display device.

During a call, the display device will display differently depending on whether a secondary display device is connected and the video input source you select. You can change the video input source via the remote control and web user interface.

To change video input when the system is idle via the remote control:

1. If  is set to **Input** key, press  to open video input source.
For more information on how to customize the key, refer to [Custom Key Type](#) on page 61.
The display device shows Camera and PC input sources.
2. Press  or  to select the desired input source, and then press .
The display device shows the selected source.



To change video input during a call via the remote control:



1. Do one of the following to open video input source:

- If  is set to **Input** key, press .

For more information on how to customize the key, refer to [Custom Key Type](#) on page 61.



- Press  or  to open **Talk Menu**.

Press  or  to scroll to **Other** and then press  to expand the menu.

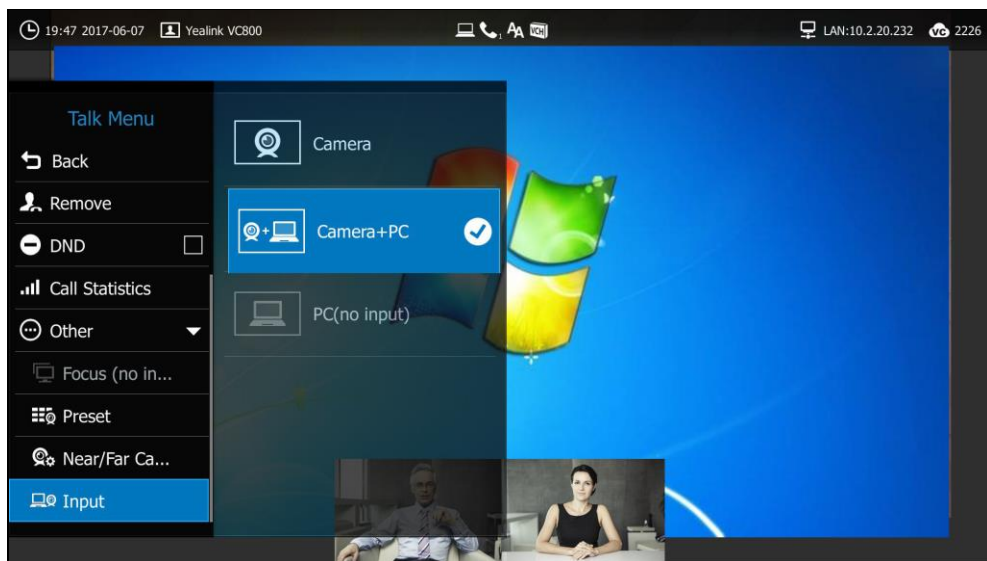
Press  or  to scroll to **Input** and then press  to enter submenu.



The display device shows **Camera**, **Camera +PC** and **PC** input sources.

2. Press  or  to select the desired input source , and then press .

- If you select **PC**, the remote video image is shown in big size, and the PC content is shown in small size.
- If you select **Camera+PC**, the PC content is shown in big size, and other video images are shown in small size.
- If you select **Camera**, the layout is shown in the PIP (Picture-in-Picture).

3. Press  to return.

Video input is configurable via web user interface at the path **Home->Input**.

Presentation

The system supports sharing video and documents on a PC while simultaneously displaying the main video. We recommend using dual display devices for sharing contents.





During a call, if a PC is connected to the VCH50 video conferencing hub, the VC800 system will start presentation automatically. You can also start/stop presentation manually during a call via

the remote control or CP960 conference phone. The presentation stops automatically if the PC is disconnected from the system.

During a voice call, only local display device displays the PC content. During a video call, both local and remote display devices display PC contents. Only one content can be shared at a time. A presentation started later will replace the previous one.









To start/stop presentation manually when the system is idle:

If a PC is connected to the VCH50 video conferencing hub, but a presentation does not start automatically, do one of the following to start or stop a presentation manually:

- If  is set to **Presentation** key, press  to start or stop presentation.
For more information on how to customize the key, refer to [Custom Key Type](#) on page 61.
- Tap  on the CP960 conference phone to start presentation.
- Tap  on the CP960 conference phone to stop presentation.

To start/stop presentation manually during a call:

If a PC is connected to the VCH50 video conferencing hub, but a presentation does not start automatically, do one of the following to start or stop a presentation manually:

- If  is set to **Presentation** key. Press  to start or stop presentation.
For more information on how to customize the key, refer to [Custom Key Type](#) on page 61.
- Press  or  to open **Talk Menu**.
Press  or  to scroll to **Presentation**, and then press  to start or stop presentation.
- Tap  on the CP960 conference phone to start presentation.
- Tap  on the CP960 conference phone to stop presentation.

Note

You can also start a presentation by changing the video layout. For more information, refer to [Changing Video Layout](#) on page 132.

Configuring Camera Presets

Camera presets are stored camera pan, tilt, and zoom settings. Presets enable you to quickly point a camera at pre-defined locations. Presets remain in effect until you change them. Up to 12 presets can be saved.

Camera presets are configurable via the remote control or web user interface.

Storing a Camera Preset

To store a camera preset during a call:

1. Press  or  to open **Talk Menu**.

2. Press ▲ or ▼ to scroll to **Other** and then press (OK) to expand the menu.
3. Press ▲ or ▼ to scroll to **Preset** and then press ► to enter submenu.
4. Select **New Preset**, and then press (OK).

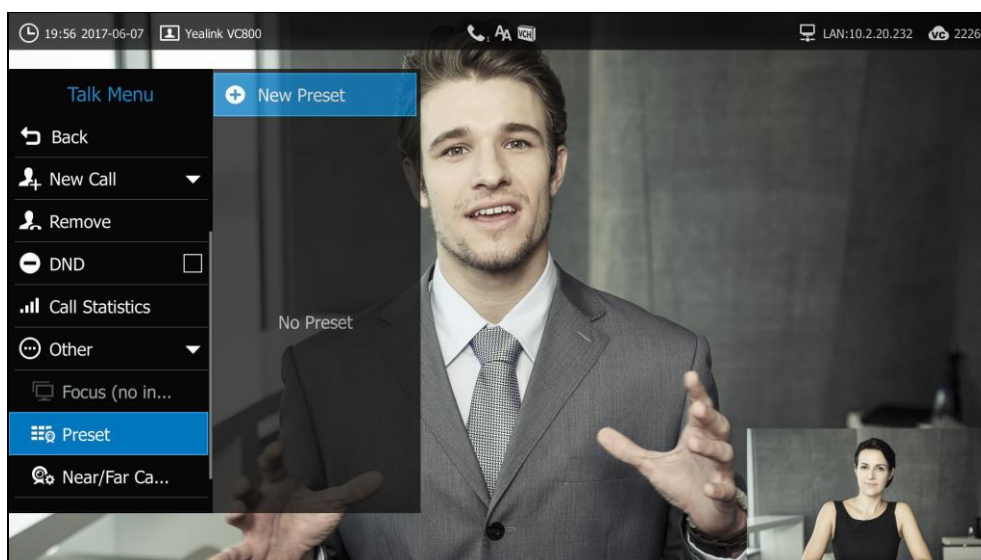

5. Press the navigation key to adjust the angle of the camera or press ⊕ or ⊖ to adjust the focus of the camera.
6. Press (OK) to store the camera preset.

Moving Local Camera to a Preset Position

To move the local camera to a preset position during a call:

1. Press ☰ or (OK) to open **Talk Menu**.
2. Press ▲ or ▼ to scroll to **Other** and then press (OK) to expand the menu.
3. Press ▲ or ▼ to scroll to **Preset** and then press ► to enter submenu.
4. Select a stored preset, and then press (OK) to move local camera to this stored preset.

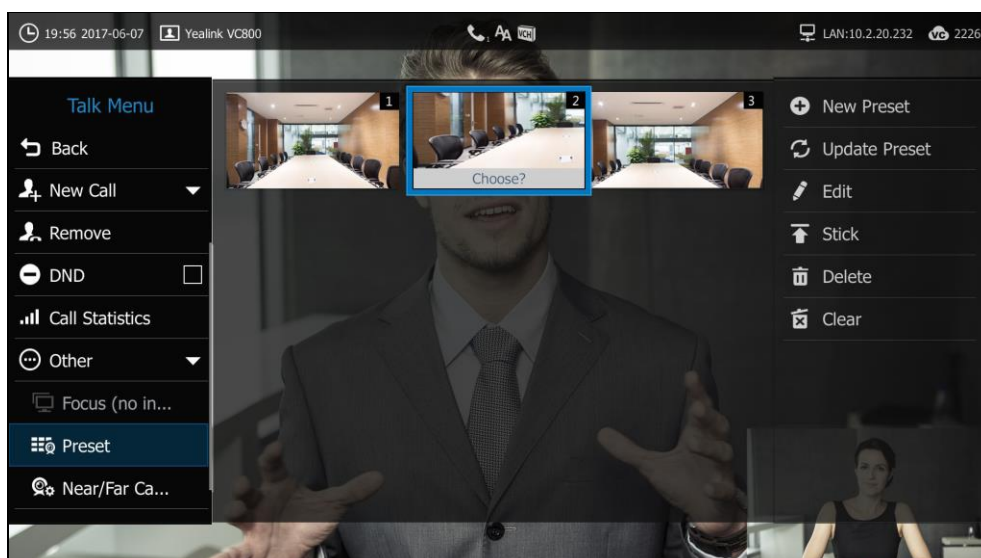

You can also press the numeric key that is already associated with a preset. But in this way, you can only move local camera to 10 preset positions (corresponding to 0 to 9 key on the remote control) at most.

To move the local camera to a preset position via web user interface:









1. Click **Home**.
2. Hover your cursor over yourself on the left side of the screen, and then click  .
3. Click a number to move local camera to this stored preset.

You can move local camera to 12 preset positions (corresponding to 0 to 12 key on the web user interface).

Updating the Stored Preset

You can update the stored presets to see the current preview screens. It helps you decide where you want your camera to move.

To update the stored preset during a video call:

1. Press  or  to open **Talk Menu**.
2. Press  or  to scroll to **Other** and then press  to expand the menu.
3. Press  or  to scroll to **Preset** and then press  to enter submenu.
4. Select **Update Preset**, and then press  .

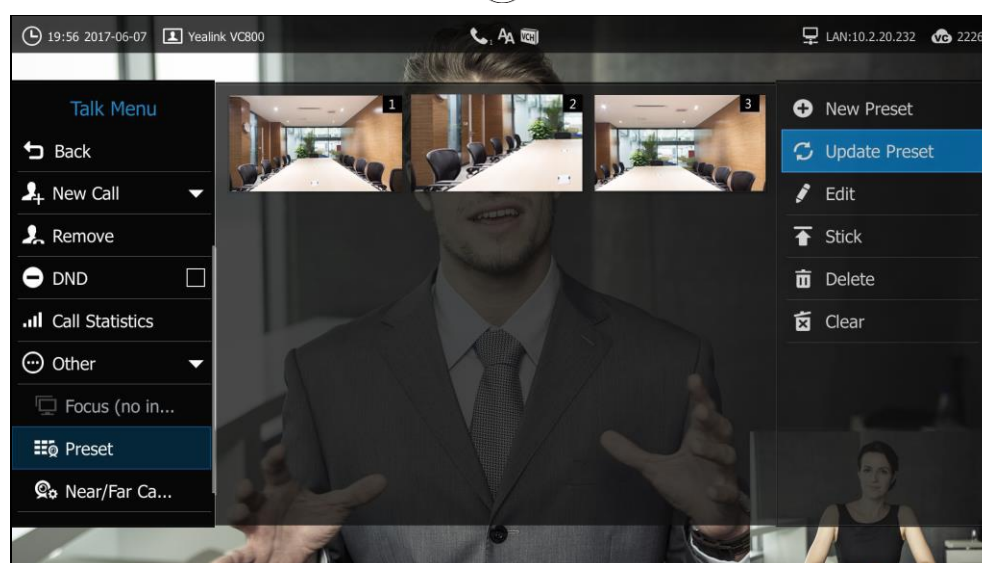





All preview screens will be updated.

Editing the Stored Preset

You can edit the stored presets to adjust camera angle and focus.

To edit the stored preset during a video call:

1. Press  or  to open **Talk Menu**.
2. Press  or  to scroll to **Other** and then press  to expand the menu.

3. Press ▲ or ▼ to scroll to **Preset** and then press ► to enter submenu.
4. Select **Edit**, and then press (OK).

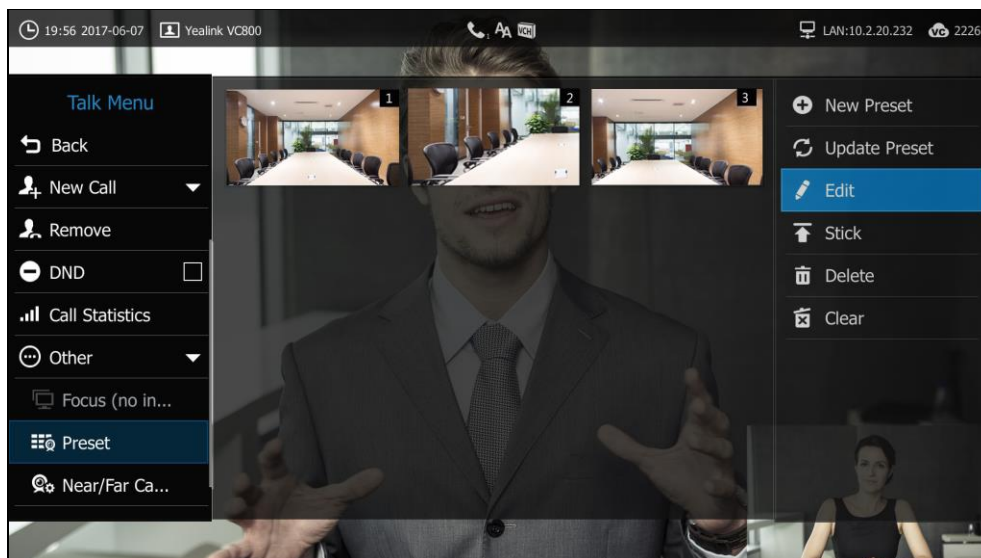

5. Select a preset, and then press (OK).
6. Press the navigation key to adjust the angle of the camera or press ⊕ or ⊖ to adjust the focus of the camera.
7. Press (OK) to store the camera preset.
8. Press (Back) to return.

Placing a Preset at the Top

To place a preset at the top list during a video call:

1. Press (Menu) or (OK) to open **Talk Menu**.
2. Press ▲ or ▼ to scroll to **Other** and then press (OK) to expand the menu.
3. Press ▲ or ▼ to scroll to **Preset** and then press ► to enter submenu.

4. Select **Stick**, and then press **OK** .

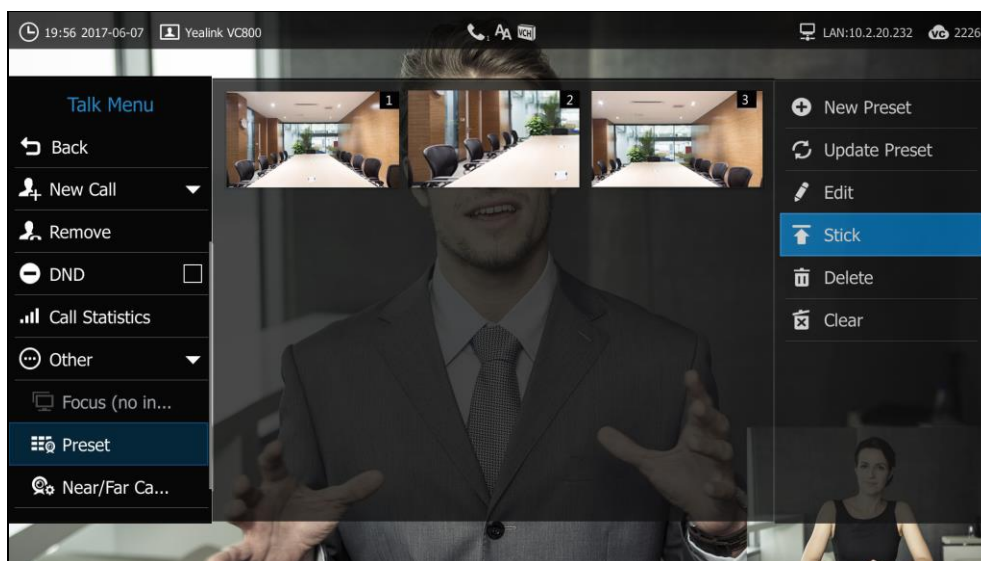

5. Select a preset, and then press **OK** .
The selected preset is placed at the top.
6. Press **Back** to return.

Deleting the Stored Preset

To delete the stored presets during a video call:

1. Press **Menu** or **OK** to open **Talk Menu**.
2. Press **Up** or **Down** to scroll to **Other** and then press **OK** to expand the menu.
3. Press **Up** or **Down** to scroll to **Preset** and then press **Right** to enter submenu.
4. Select **Delete** and then press **OK** .

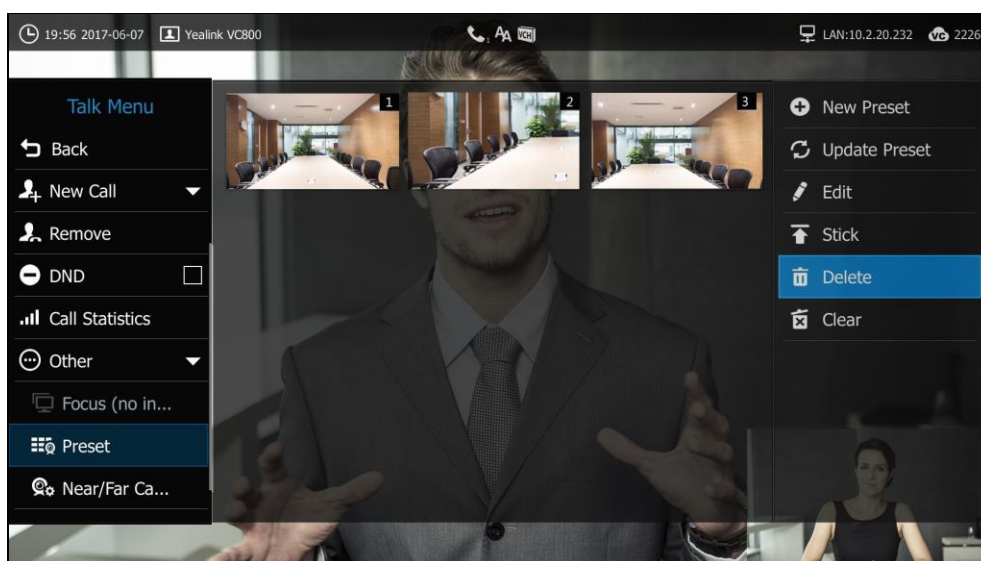



5. Select the stored presets, and then press **OK** .

6. Press ▲ or ▼ to scroll to **OK** and then press **OK** to delete selected presets.
7. Press  to return.

Clearing the Stored Preset

To clear the stored presets during a video call:

1. Press  or **OK** to open **Talk Menu**.
2. Press ▲ or ▼ to scroll to **Other** and then press **OK** to expand the menu.
3. Press ▲ or ▼ to scroll to **Preset** and then press  to enter submenu.
4. Select **Clear** and then press **OK**.

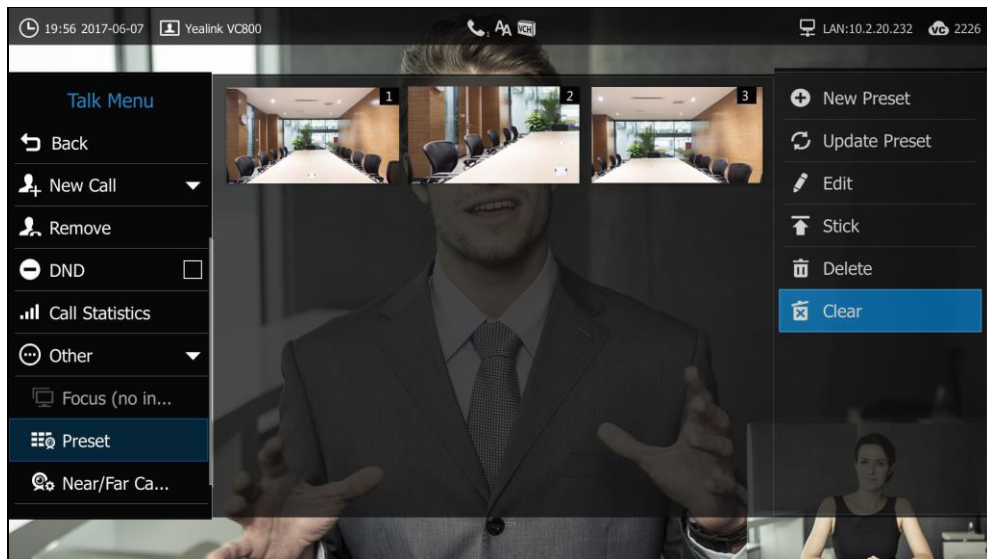

5. Press ▲ or ▼ to scroll to **OK** and then press **OK** to clear all presets.
6. Press  to return.

Video Recording

Before recording video, make sure a USB flash driver is connected to VC800 codec, VCH50 video conferencing hub or CP960 conference phone and the USB feature is enabled. For more information, please refer to [USB Configuration](#) on page 62.

The recorded video will be saved in .mkv format and named as the recorded time and date. Video can be played on either the system itself or on a computer using an application capable of playing .wav files.

Note The system supports FAT32 and NTFS format USB flash drive or removable hard drive. When using the NTFS format, only the first partition is supported.

After the USB flash drive is connected and the USB feature is enabled, the display device will prompt "USB device available now". The  icon will appear on the status bar of the display device.

Before recording video, you need to know the following:

- When recording video, it is not allowed to play or delete the video from the menu.
- When recording video, it is not allowed to capture screenshots, but you can view and delete screenshots.
- When playing video recording, it is not allowed to record again.
- When receiving or making a call, it is not allowed to record.
- If you answer an incoming call during recording, the system will go on recording.
- When recording during a video call, the record will be finished automatically after the call ends.
- When playing, recording or pausing video, the system will not go to sleep automatically.
- If you remove the working USB flash drive or insert another USB flash drive during recording, the recording will be stopped.

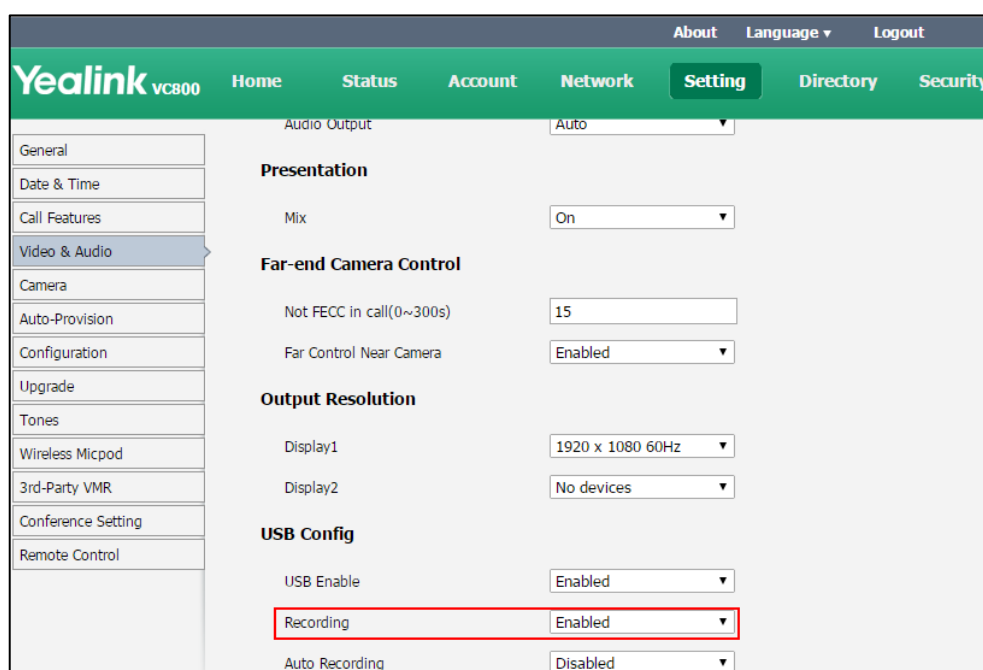

To configure video recording via web user interface:

1. Click on **Setting->Video & Audio**.
2. Select the desired value from the pull-down list of **Recording**.





3. Click **Confirm** to accept the change.



To record video via the remote control when the system is idle or during a call:

1. Press  to start recording and then press  again to stop recording.
When you start recording, the display device will show  and the recording time. When you stop recording, the recording icon disappears from the screen. The display device prompts "USB Record Succeeded".



















To record video via the CP960 conference phone when the system is idle:

1. Tap  to start recording and then tap  to stop recording.

To record video via the CP960 conference phone when the system is during a call:

1. Tap  to start recording and then tap  or **Recording** to stop recording.
When you start recording, the status bar of touch screen will prompt "Recording". When you stop recording, the display device prompts "USB recording successfully".











To view recorded video via the remote control:

1. Select  (**More** menu).
2. Press  or  to scroll to **Record** and then press  to enter submenu.
3. Press  or  to scroll to **Video** and then press .
4. Press  or  to select desired video, and then press  or select .
5. You can do the following:
 - Select  to pause the video.
 - Select  to continue playing video.
 - To skip forward the video, press . Press once to skip forward 4 seconds.
 - To rewind the video, press . Press once to rewind 4 seconds.
 - To adjust the volume of the speakerphone, press  or .
 - Select  to stop playing video.

You can also press  on the remote control to stop playing video.

When receiving an incoming call while you are playing video, the system will stop playing video automatically.

To delete recorded video via the remote control:

1. Select  (**More** menu).
2. Press  or  to scroll to **Record** and then press  to enter submenu.
3. Press  or  to scroll to **Video** and then press .
4. Press  or  to scroll to a video.
5. Select  to delete the video.

The display device prompts “Delete this video?”

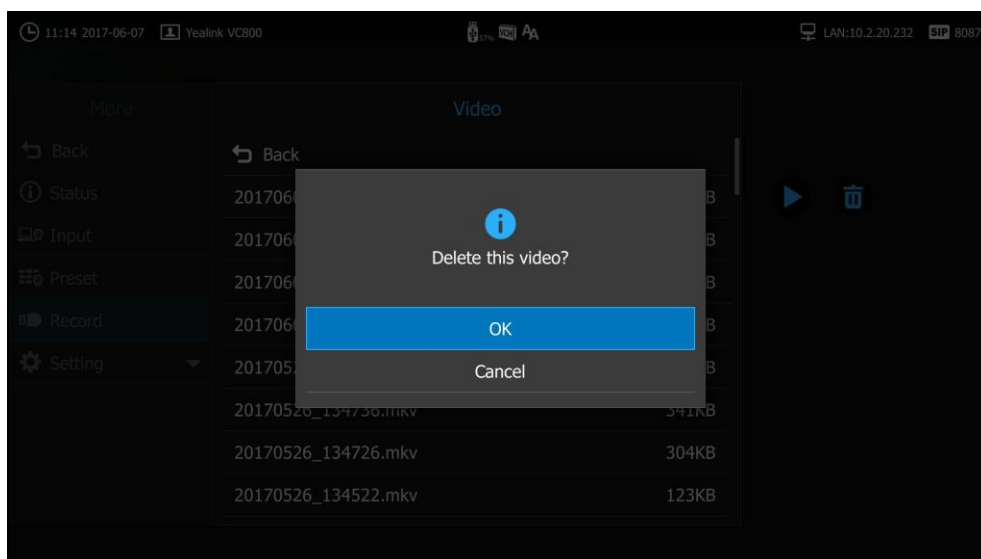

6. Press ▲ or ▼ to scroll to **OK** and then press **OK**.

Auto Recording

Auto recording feature is available only when the recording feature is enabled. If it is enabled, the system will start recording automatically once a call is established. Make sure a USB flash drive is connected and the USB feature is enabled. You can configure auto recording feature via web user interface only.

To configure auto recording feature via web user interface:

1. Click on **Setting->Video & Audio**.
2. Select the desired value from the pull-down list of **Auto Recording**.

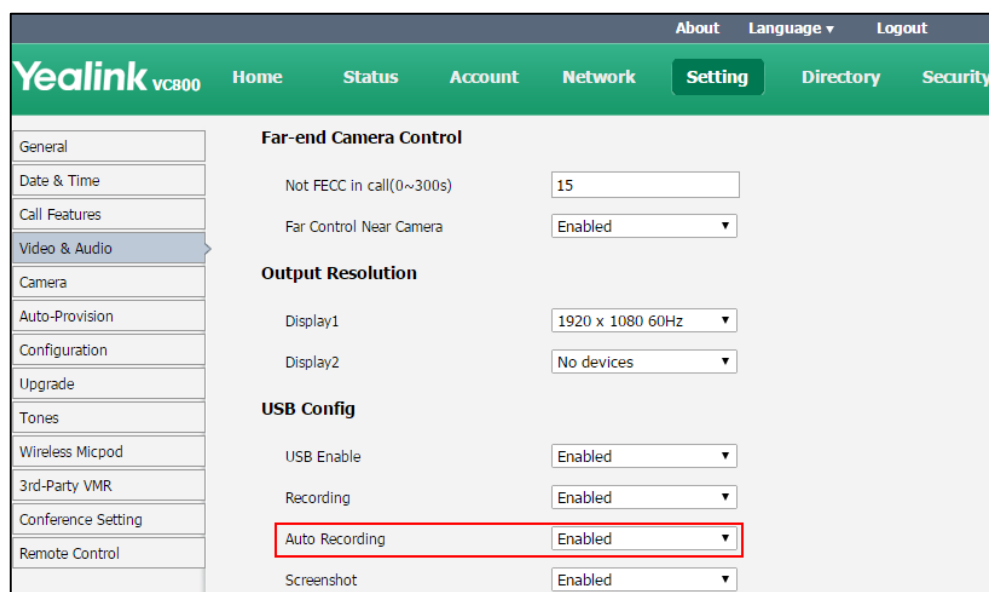

3. Click **Confirm** to accept the change.

Screenshot

You can capture the screenshot from the camera via the remote control, CP960 conference phone or web user interface. Make sure a USB flash driver is connected to VC800 codec, VCH50 video conferencing hub or CP960 conference phone and the USB feature is enabled. For more information, please refer to [USB Configuration](#) on page 62.

You can view, delete or scale the screenshots via the remote control.

When you capture a screenshot via web user interface, you can save the screenshots to the computer. The stored screenshot will be saved in .jpg format and named as the captured time and date. You can view the screenshot using an application capable of viewing .jpg pictures.

Note

The system supports FAT32 and NTFS format USB flash drive or removable hard drive. When using the NTFS format, only the first partition is supported.

After the USB flash drive is connected and the USB feature is enabled, the display device will prompt "USB device available now". The  icon will appear on the status bar of the display device.

Before capturing screenshots, you need to know the following:

- When receiving or making a call, it is not allowed to capture screenshots.
- When recording video, it is not allowed to capture screenshots.
- If multiple USB flash drives are connected, and you remove the working USB flash drive, the remained one can continue to work seamlessly.

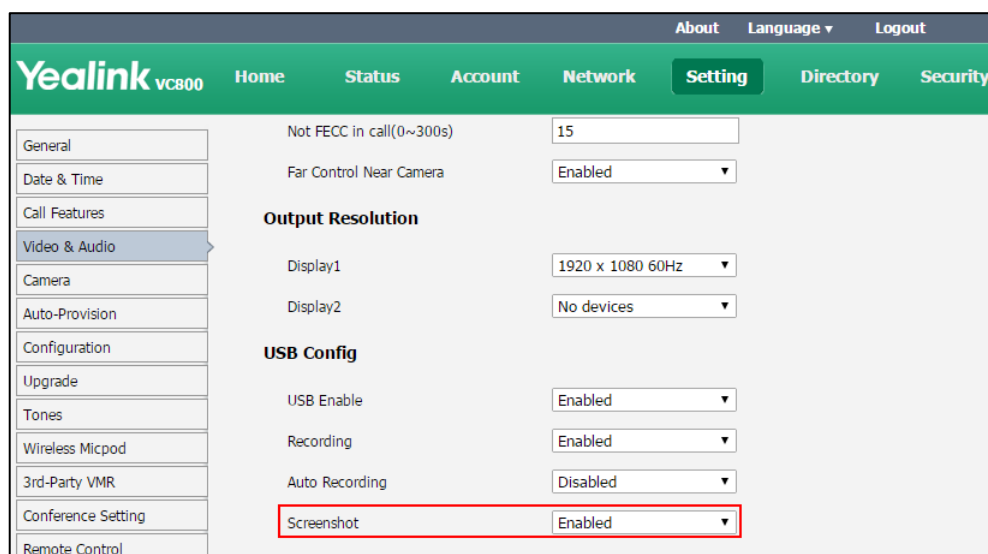

To configure screenshot feature via web user interface:

1. Click on **Setting**->**Video & Audio**.
2. Select the desired value from the pull-down list of **Screenshot**.



3. Click **Confirm** to accept the change.

To capture screenshots via the remote control when the system is idle or during a call:

1. If  is set to **Screenshot** key, press  to capture screenshot.
For more information on how to customize the key, refer to [Custom Key Type](#) on page 61.

















To capture screenshots via the CP960 conference phone when the system is during a call:

1. Tap  -> .

Capturing the screenshot via web user interface at the path **Home->Screenshot**.











Viewing Screenshots

To view screenshots via the remote control:

1. Select  (**More** menu).
2. Press  or  to scroll to **Record** and then press  to enter submenu.
3. Press  or  to scroll to **Screenshot**, and then press .
4. Press  or  to select desired screenshots, and then press  or select .
5. You can do the following:
 - Press  or  to view previous or next screenshot.
 - Press  or  to zoom screenshot in/out.
 - Select  to exit.
You can also press  on the remote control to exit.

Deleting Screenshots

To delete screenshots via the remote control:

1. Select  (**More** menu).
2. Press  or  to scroll to **Record** and then press  to enter submenu.
3. Press  or  to scroll to **Screenshot**, and then press .
4. Press  or  to select desired screenshots, and then select .

The display device prompts "Delete this screenshot?"

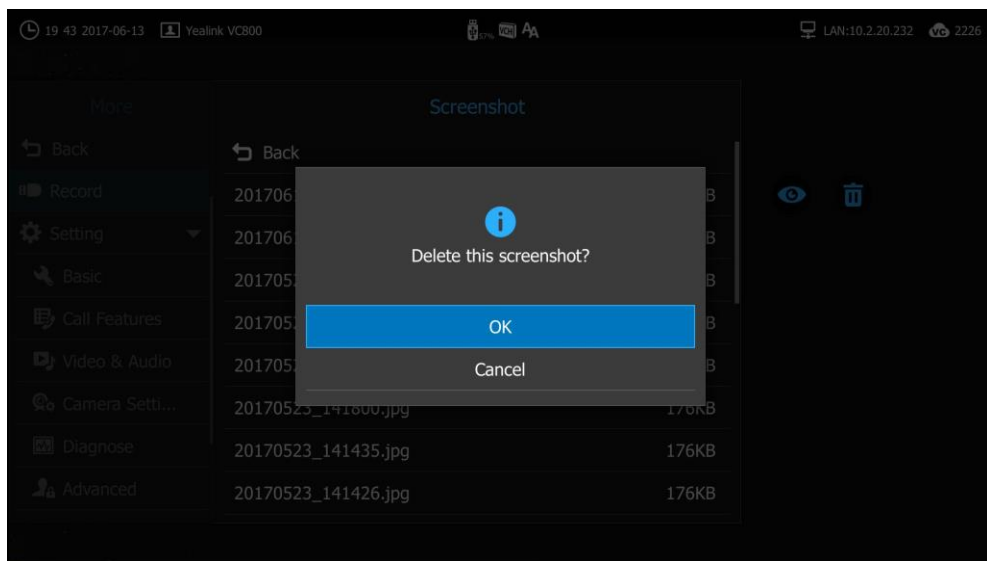





5. Press ▲ or ▼ to scroll to **OK** and then press **OK**.

Video Layout

The total number of available screen layouts depends on the number of connected callers, whether a single display or a dual display is used, and whether a presentation is being viewed.

Screen layouts appear as one of the following types:

- OnePlusN** (): In this layout, the assigned participant is given prominence in the largest pane regardless of who is currently speaking. Other participants are displayed in a strip beside the assigned speaker.
- Selected Speaker** (): In this layout, only the selected speaker is seen in a large pane.
- Equal N×N** (): In this layout, every participant is given equal prominence in equal-sized panes.
- Picture-in-Picture** (): During two-way video calls, the far end or your site (the near end) is shown in full screen, while the other participant is shown in the PIP (Picture-in-Picture).
- Speaker View** (): During multi-way video calls, the active speaker is given prominence in the largest pane. Other participants are displayed in a strip beside the active speaker.

Changing Video Layout

To change screen layout via the remote control:

1. Press  during a call.

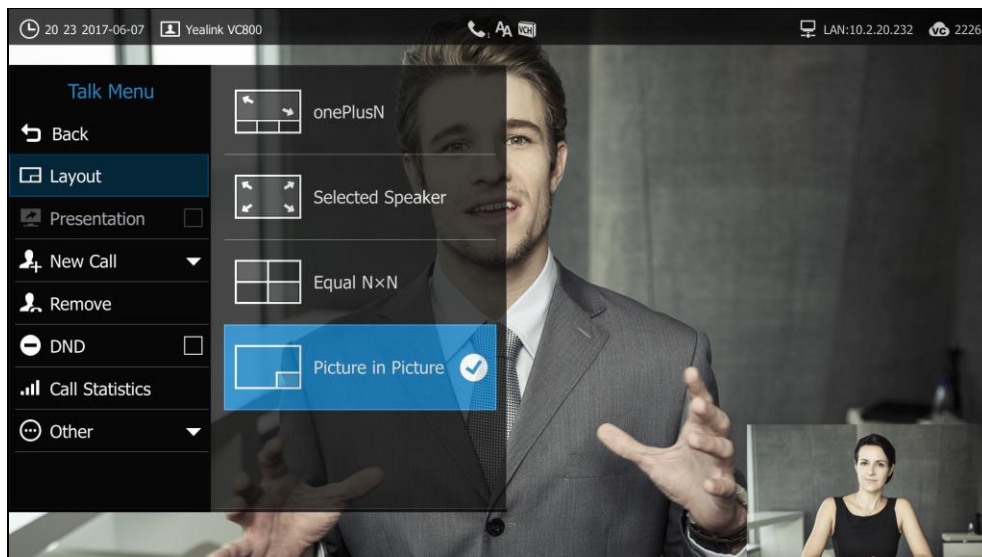

2. Select the desired layout, and then press  .

To change screen layout via the CP960 conference phone:

1. Tap  during a call.
2. Tap the desired layout.

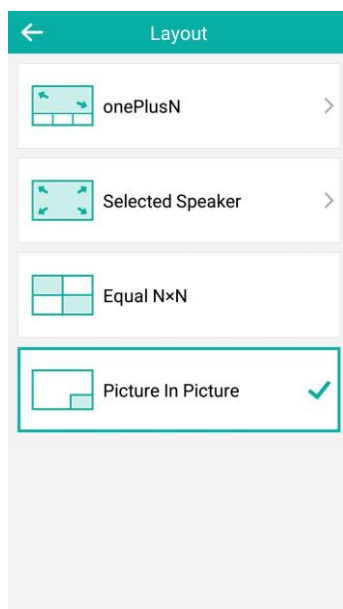

Single Display Screen Layouts

Two-way Video Calls

Picture-in-picture layout is used by default.

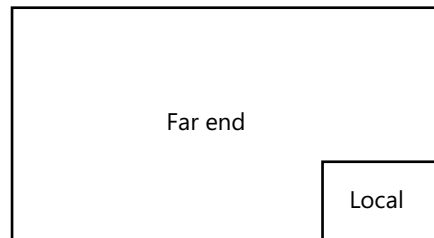

Two-way Video Call with a Presentation

The PC content is given prominence in the largest pane. Other participants are displayed in a strip beside the PC content.

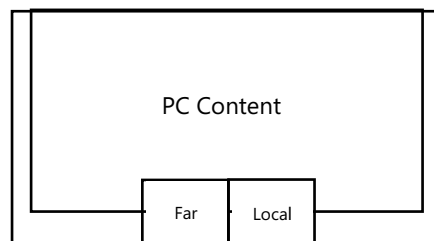

Multi-way Video Calls

Take four-way video calls as an example.

Voice activation layout is used by default. The active speaker is given prominence in the largest pane. Other participants are displayed in a strip beside the active speaker.

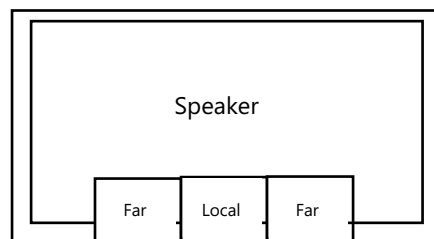

Multi-way Video Call with a Presentation

Take four-way video calls as an example.

Voice activation layout is used by default. The PC content is given prominence in the largest pane. Other participants are displayed in a strip beside the PC content. The speaker is fixed at the bottom-left corner.

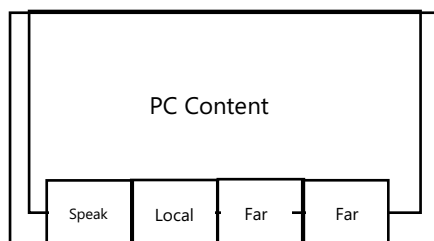

Dual Display Screen Layouts

To make it easier for users to view video images, users can connect two display devices to Display1 and Display2 ports respectively. When two display devices are connected to the VC800 codec, the status bar of the primary display device will display  icon.

Two-way Video Calls

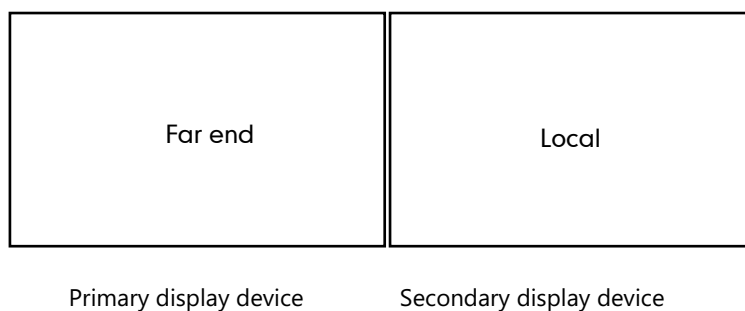

Two-way Video Call with Presentation

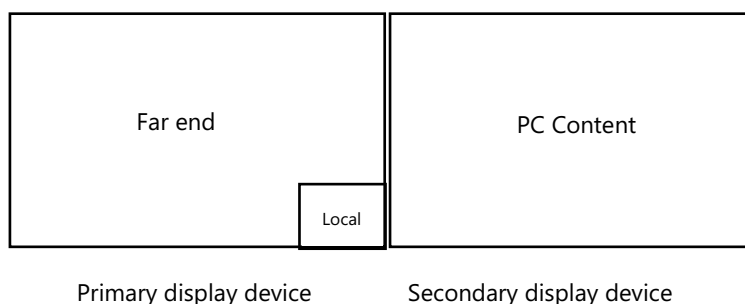

Multi-way Video Calls

Take four-way video calls as an example. Voice activation layout is used by default.

Primary display device: The active speaker is given prominence in the largest pane. Other participants are displayed in a strip beside the active speaker.

Secondary display device: local image is seen in a large pane.

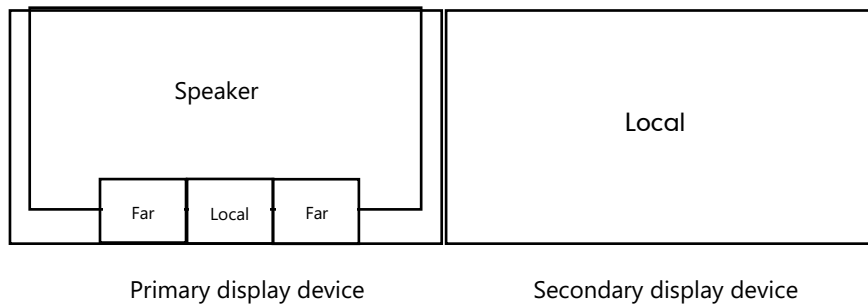

Multi-way Video Call with Presentation

Take four-way video calls as an example. Voice activation layout is used by default.





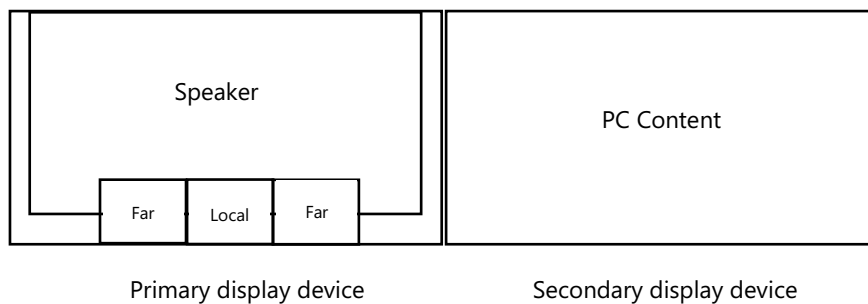





Primary display device: The active speaker is given prominence in the largest pane. Other participants are displayed in a strip beside the active speaker.

Secondary display device: PC content is seen in a large pane.



Specifying Content to the secondary display device

To specify the content to be displayed on the secondary display device via the remote control:

1. Press  or  to open **Talk Menu**.
2. Press  or  to scroll to **Other**, and then press  to expand the menu.
3. Press  or  to scroll to **Focus (Display2)** and then press  to enter submenu.
4. Press  or  to scroll to select the desired content, and then press .

The secondary display device displays the selected content. The  icon is displayed on the focus content.

After reassigning the content, the PC content on the second display device will automatically be displayed on the primary display device.

Voice Activation

Voice activation displays the active speaker in largest pane. Other participants are displayed in a strip beside the active speaker. To minimize the changes in the layout, when a new speaker is identified, the previous speaker is replaced by the new speaker. You can configure voice

activation via web user interface only.

To configure the voice activation via web user interface:

1. Click on **Setting**->**Conference Setting**.
2. Select the desired value from the pull-down list of **Voice Activation**.
3. Select the desired value from the pull-down list of **Video Hold Active Duration**.

When a participant's voice duration is greater than this duration (1 second), the system refreshes the display and replaces the last active speaker with the active speaker.

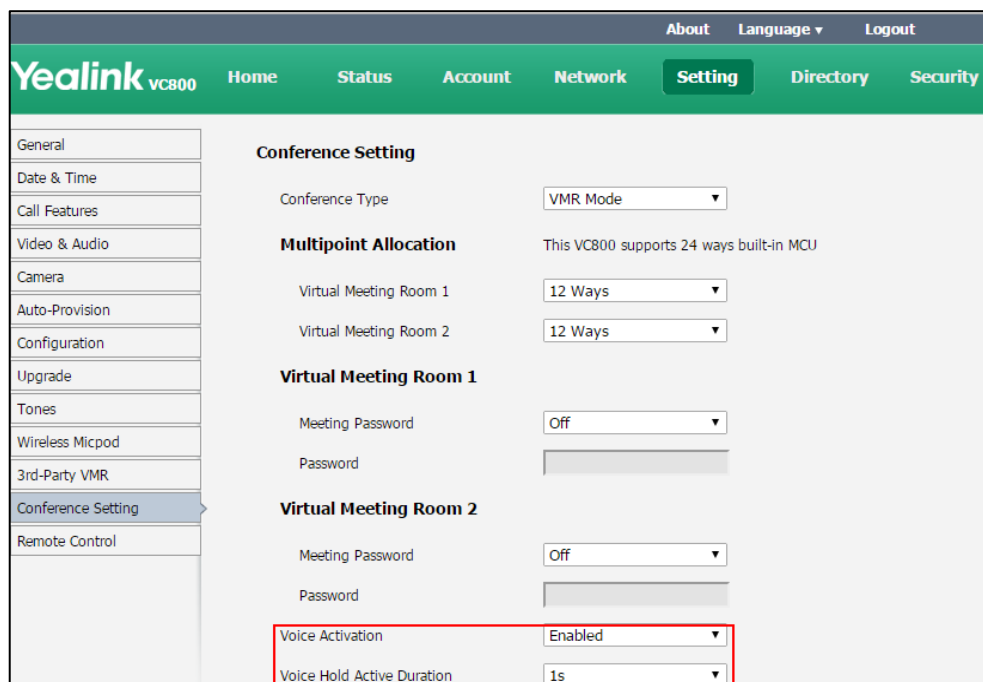

4. Click **Confirm** to accept the change.

Note Voice activation takes effect only when there are more than two participants in a conference call.

View Switching

View switching enables to switch video images on the display device automatically. The switching is initiated when the number of participants exceeds the number of windows in the selected video layout. You can configure view switching via web user interface only.

Average Mode

Up to 9 video images can be displayed in **Equal N×N** layout. When the number of participants exceeds 9, all participants' video images will be switched automatically.

To configure view switching via web user interface:

1. Click on **Setting**->**Conference Setting**.

- In the **Average Mode** field, select the desired value from the pull-down list of **View Switching Interval**.

By default, the video images will be switched automatically every 30 seconds.

- Do one of the following:

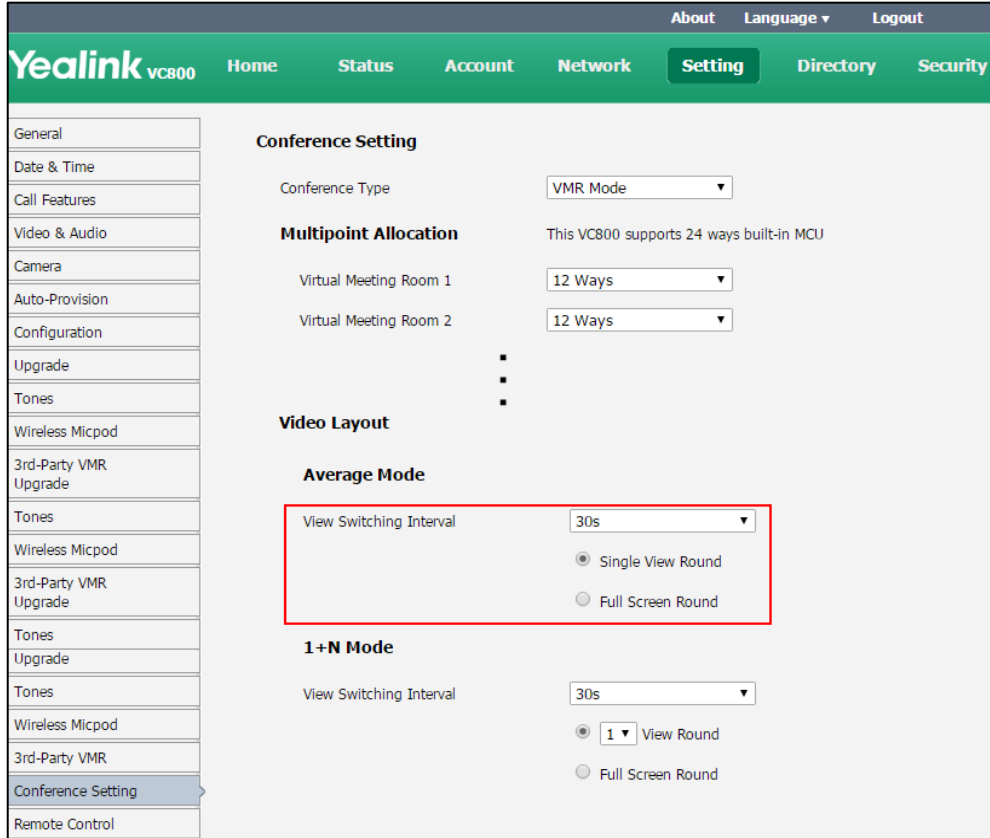

- Mark the **Single View Round** radio box to switch one video image at a time.
- Mark the **Full Screen Round** radio box to switch all video images at a time.

- Click **Confirm** to accept the change.

Note

In **Equal N×N** layout, video image of the active speaker is indicated by an orange border. If you shares content in **Equal N×N** layout, the location of PC content is fixed at the top-left corner and will not be switched automatically.

1+N Mode

Up to 8 video images can be displayed in **Speaker View** layout and **OnePlusN** layout. When the number of participants exceeds 8, all participants' video images (except the active speaker) will be switched automatically.

To configure view switching via web user interface:

- Click on **Setting->Conference Setting**.

- In the **1+N Mode** field, select the desired value from the pull-down list of **View Switching Interval**.

By default, the video images will be switched automatically every 30 seconds.

- Do one of the following:

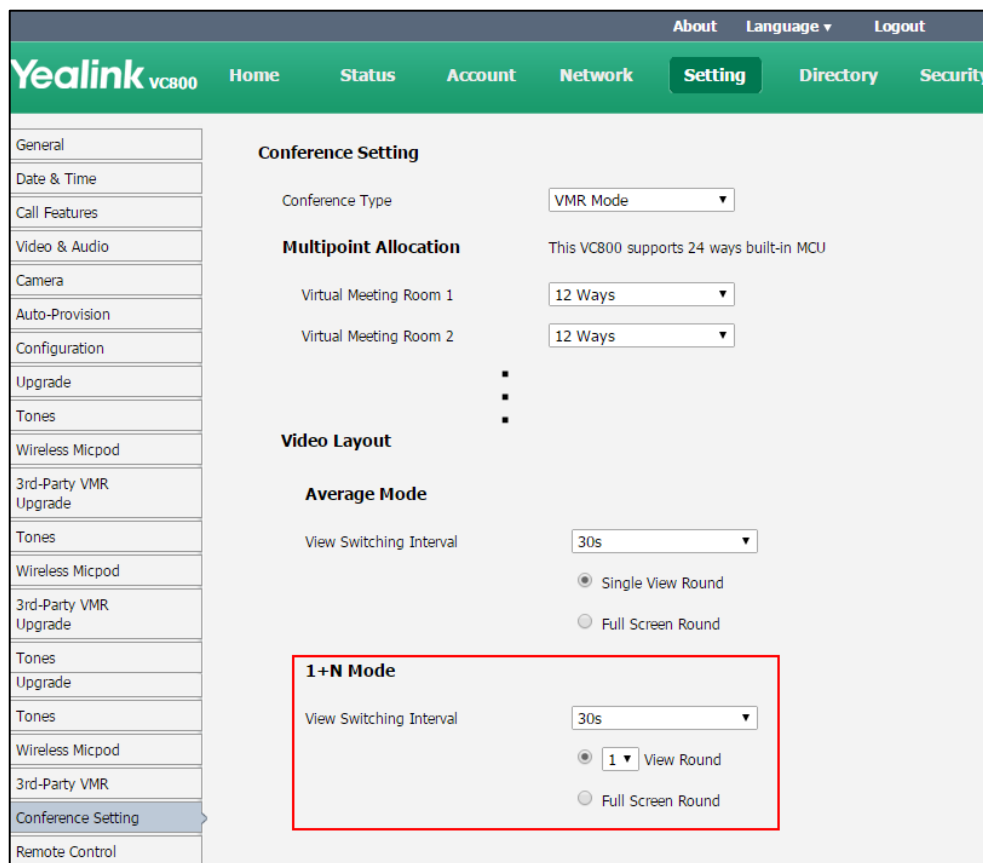

- Select the desired value from the pull-down list of **View Round**.
You can configure how many video images to be switched at a time.
- Mark the **Full Screen Round** radio box to switch all video images at a time.

- Click **Confirm** to accept the change.

Note

If you share content in **Speaker View** layout and **OnePlusN** layout, the PC content is given prominence in the largest pane. The active speaker is fixed at the bottom-left corner, and other video images will be switched automatically.

Video Conference Platform

Yealink video conferencing system can log into the Yealink VC Cloud Management Service/Yealink Meeting Server/StarLeaf/Zoom/Pexip/BlueJeans/Mind/Custom platform.

Users can access Virtual Meeting Rooms(VMR) using Yealink video conferencing system, whilst benefiting from both the features provided by Yealink, such as 1080p HD video and audio, and features provided by StarLeaf/Zoom/Pexip/BlueJeans/Mind, including high end customization & interoperability.

If you don't log into Cloud platform or you only log into the Yealink VC Cloud Management Service platform/Yealink Meeting Server, you can configure the address of the third-party platform in advance. So that your dialing screen will appear this third-party platform, even if you don't log into the third-party platform, you can still select the desired third-party platform to call corresponding VMRs quickly. For more information, refer to [Yealink VC800 Full HD Video Conferencing System Administrator Guide](#).

This chapter provides the information about using the Cloud platform. Topics include:



- [Using the Yealink VC Cloud Management Service Platform](#)
- [Using the Yealink Meeting Server](#)
- [Using the StarLeaf Cloud Platform](#)
- [Using the Zoom Cloud Platform](#)
- [Using the BlueJeans Cloud Platform](#)
- [Using the Pexip Platform](#)
- [Using the Mind Platform](#)
- [Using the Custom Platform](#)

Using the Yealink VC Cloud Management Service Platform

You can log into the Yealink VC Cloud Management Service platform, and dial other Yealink Cloud accounts to establish calls.





Dialing Yealink Cloud Accounts

To dial Yealink Cloud numbers via the remote control:

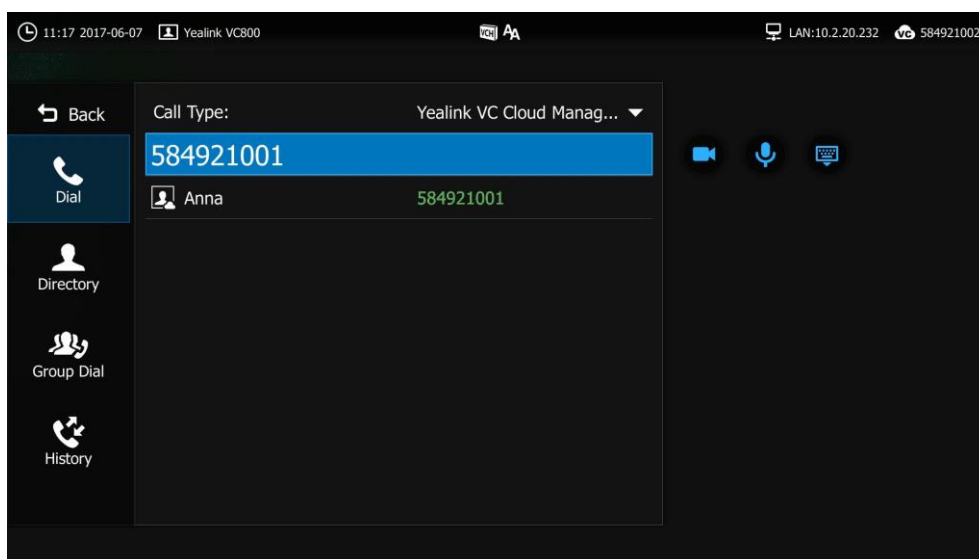
1. Select  (Dial menu) or press  to enter the pre-dialing screen.
2. Select **Yealink VC Cloud Management Service** from the pull-down list of **Call Type** before calling.

3. Enter the desired Yealink Cloud number using the keypad or the on-screen keyboard.



7. Press  to select  (video call) or  (voice call), and then press  to dial out the number.

To dial Yealink Cloud numbers via the CP960 conference phone:

1. Tap  .
2. Tap the **Auto** field.
3. Tap **Yealink VC Cloud Management Service** in the pop-up dialog box.

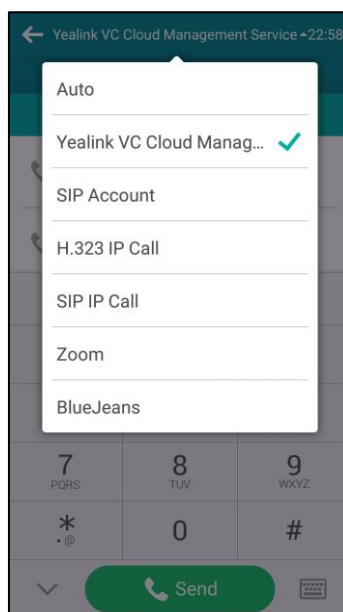

4. Enter the desired Yealink Cloud number.

5. Tap **Send**.

Note

If you want to place a call to a Yealink Cloud contact who is in the same Yealink Cloud directory as you, you can enter the 9-digit Cloud number or the extension (the last four Cloud number) to place a call. If you want to place a call to a Cloud contact who is in different Yealink Cloud directory from you, you should enter the 9-digit Cloud number to place a call.

If you log into Yealink VC Cloud Management Service platform using the built-in Cloud number, your directory will not include the Yealink Cloud contacts, but you can dial other Yealink Cloud accounts.

Cloud call is encrypted by default. You will see an encryption icon  during a Cloud call.

Using the Yealink Meeting Server



You can register a YMS account.

When you are using the YMS account, you can:



- Dial the other YMS accounts to establish a conversation.
- View and Join a scheduled conference.
- Initiate or join a meet now conference.
- Manage the YMS video conference

Dialing YMS Accounts

To dial a YMS account using the remote control:

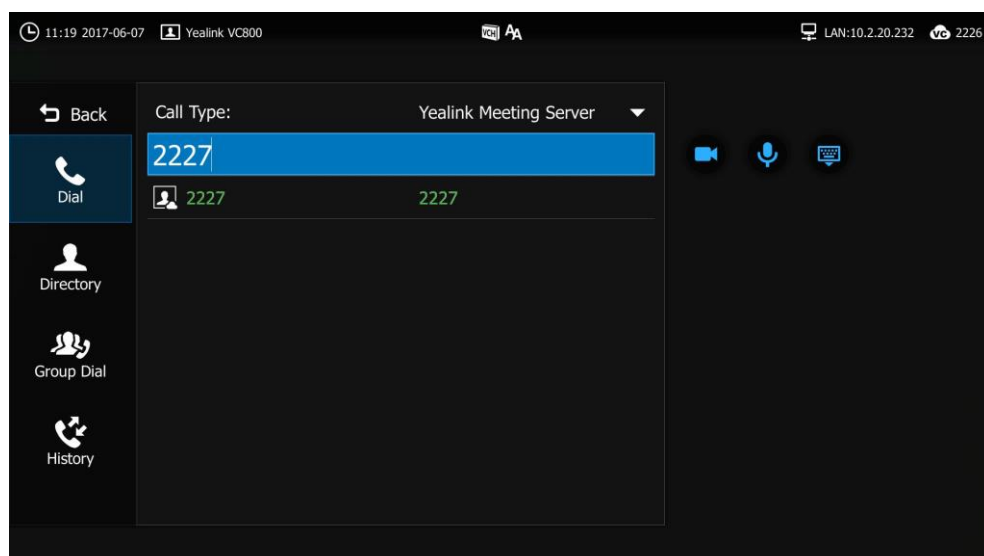
1. Select  (**Dial** menu) or press  to enter the pre-dialing screen.
2. Select **Yealink Meeting Server** from the pull-down list of **Call Type** before calling.
3. Enter the desired YMS account using the keypad or the on-screen keyboard.



8. Press ► to select  (video call) or  (voice call), and then press  to dial out the number.

To dial a YMS account via the CP960 conference phone:

1. Tap  .
2. Tap the **Auto** field.
3. Tap **Yealink Meeting Server** in the pop-up dialog box.

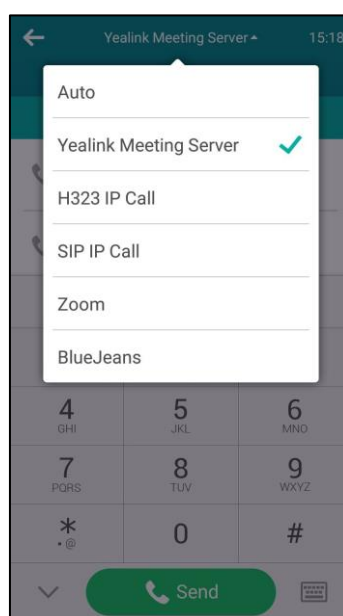

4. Enter the desired YMS account.
5. Tap **Send**.

YMS Video Conference

When you register a YMS account, you can use video conference feature.

There are two types of YMS video conference:

- Scheduled conference: You should schedule the conference using the Yealink Meeting Server or Microsoft Outlook software.
- Meet Now: You can initiate a meet now conference at any time, without a reservation.

Note

If more than one IP phone registered the same YMS account join the same conference, the former IP phone which joined the conference will leave the conference automatically. The conference only allows one of them to join the conference.

Scheduled Conference

You can schedule a conference using the Yealink Meeting Server or Microsoft Outlook software. After you schedule the conference, the scheduled conference will be added to all invitees' video

conferencing system. And invitee whose YMS account is associated with an email address, will receive an email about how to join the conference.

For more information on how to schedule a conference using the Yealink Meeting Server or Microsoft Outlook software, refer to [Yealink Meeting Server User Guide](#).

Viewing Conference Schedules

When you schedule a conference or receive an invitation to a conference, the conference details will appear on the idle screen and the menu.

If the conference organizer edits the conference content (e.g., time and participants) or cancel the conference via Yealink Meeting Server or Microsoft Outlook software after you have sent the invitation, the conference schedule will update in real time. Expired conferences will not be displayed on your VC800 video conferencing system and CP960 conference phone.

To view your conference schedules on the idle screen:

The idle screen of display device and CP960 conference phone displays the upcoming or ongoing conference schedules for today.

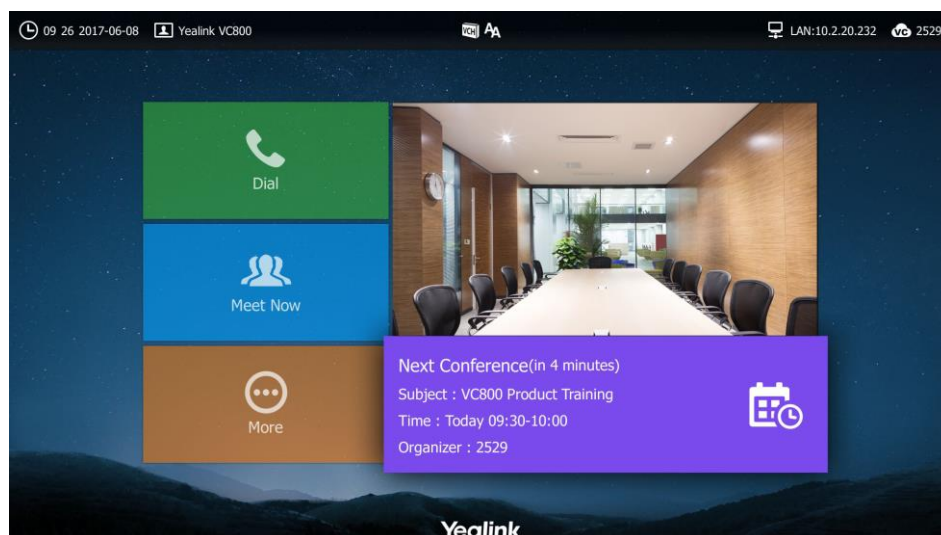

To view your conference schedules on the device display when you are sharing contents:

The idle screen will display the upcoming or ongoing conference schedules for today. And the conference schedule will be hidden in 5 seconds.

The conference schedule will appear again 30 minutes before the conference starts, and then be hidden automatically. And it will appear every 10 minutes until the conference starts. The conference schedule shows the conference details, as below:

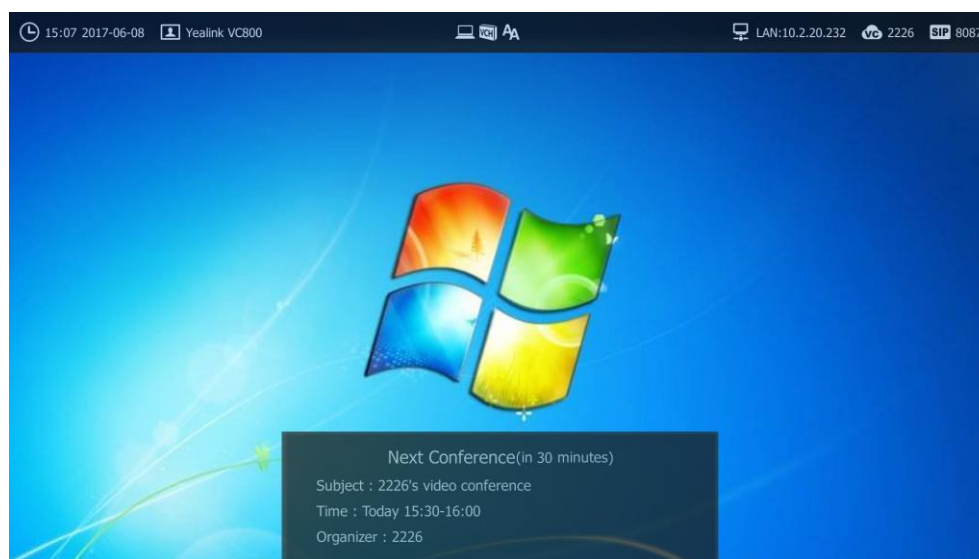

The conference reminder will appear 5 minutes before the conference starts. For more information, refer to [Joining a Scheduled Conference](#) on page 146.

To view your conference schedules on the CP960 conference phone:

1. The touch screen displays the upcoming or ongoing conference schedules for today.



To view schedule conferences in the menu via the remote control:

1. Select  (Schedule menu).

Your ongoing conferences and upcoming conferences are listed for the latest month.

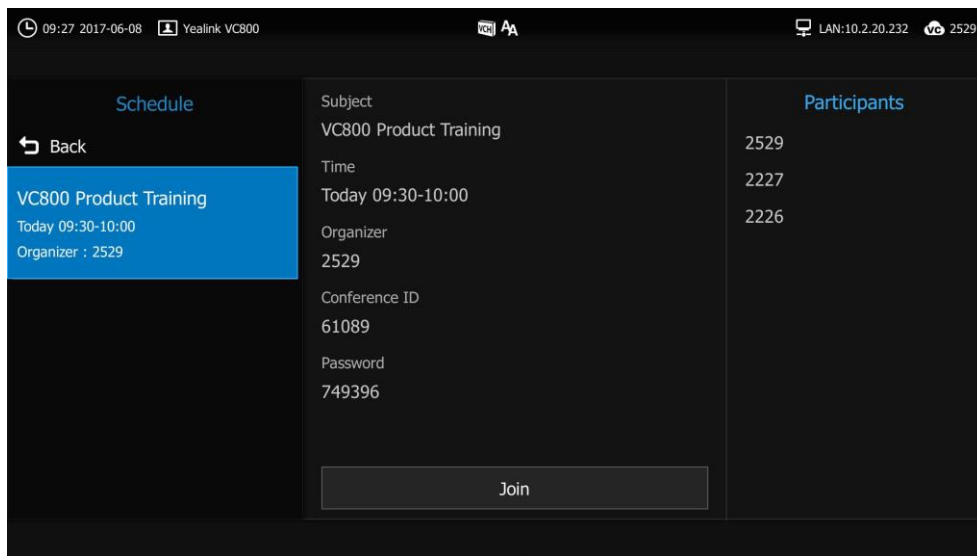

2. Press ▲ or ▼ to scroll to the desired conference.

You can view subject, time, organizer, ID, password and participants.

To view schedule conferences in the menu via the CP960 conference phone:

1. Tap  .

Your ongoing conferences and upcoming conferences are listed for the latest month.

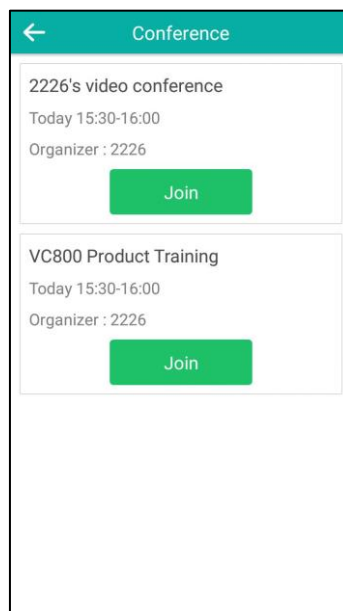

2. Tap the desired conference.

You can view subject, time, organizer, ID, password and participants.

Joining a Scheduled Conference

You can join conferences in following three ways:

- Joining a scheduled conference from a conference reminder
- Joining a scheduled conference from the conference schedule
- Joining a scheduled conference from notification center of CP960
- Dialing to join a scheduled conference

Note

By default, you can join a scheduled conference that is about to take place in 5 minutes or less. The administrator can configure when participants can join the scheduled conference. For more information, please contact your administrator.

Joining a Scheduled Conference from a Conference Reminder

A reminder pop-up is displayed 5 minutes before the conference starts. The reminder shows the main information of the schedule, including subject, date & time and organizer.

Do one of the following via the remote control:

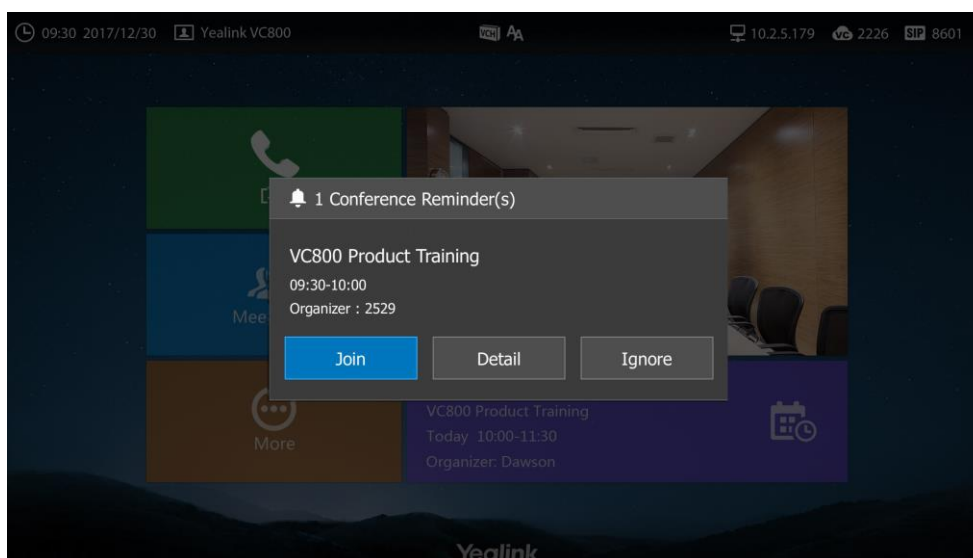

- Select **Join**, and press **OK** to join the scheduled conference.
- Select **Detail**, and press **OK** to view conference details.

- Select **Ignore**, and press  to remove the reminder from the screen and stop all future reminders for this schedule.

Do one of the following via the CP960 conference phone:

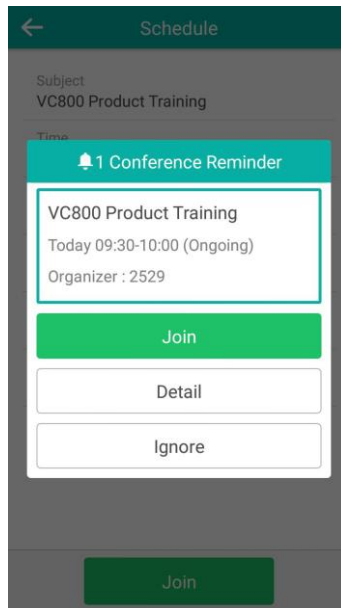

- Tap **Join** to join the scheduled conference.
- Tap **Detail** to view conference details.
- Tap **Ignore** to remove the reminder from the screen and stop all future reminders for this schedule.

Note

When the system is in a call, the conference reminder will not pop up. After the call ends and the scheduled conference is still ongoing, the reminder will pop up. But if the scheduled conference ends, the reminder will not pop up.

Joining a Scheduled Conference from Conference Schedules

To join a schedule conferences from conference schedule via the remote control:

1. Select  (**Schedule** menu).
Your ongoing conferences and upcoming conferences are listed for the latest month.
2. Press ▲ or ▼ to scroll to the desired conference.
When the conference is about to take place in 5 minutes or less, a **Join** soft key appears by default.

3. Select the **Join** soft key, and then press  .

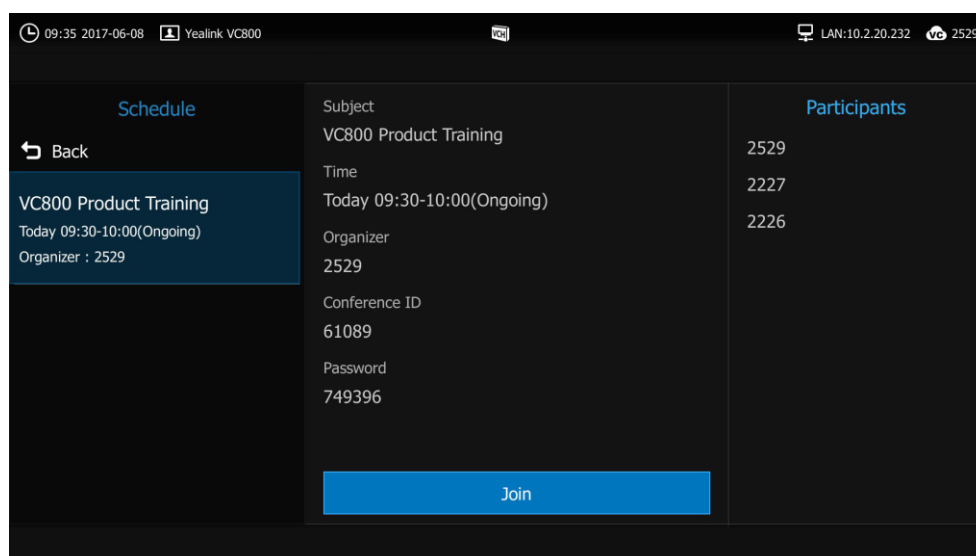

To join a schedule conferences from conference schedule via the CP960 conference phone:

1. Tap  .
2. Your ongoing conferences and upcoming conferences are listed for the latest month.
3. Tap the desired conference.
4. When the conference is about to take place in 5 minutes or less, the **Join** soft key turns green by default.
5. Tap **Join**.

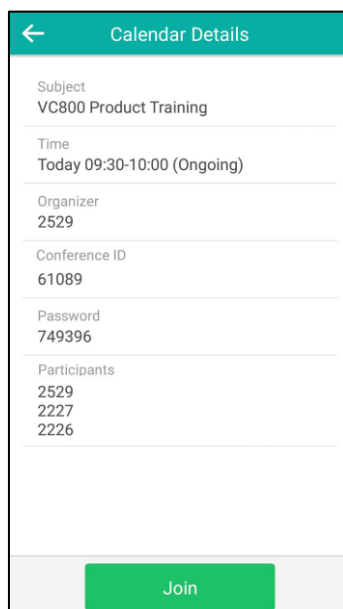

Joining a Scheduled Conference from Notification Center

By default, when the conference is about to take place in 5 minutes, the status bar displays the icon  and the notification center displays the conference information. You can tap the desired conference notification to join the conference in advance. Or during the conference, you

can tap the desired conference notification to join the conference.

To join a schedule conferences from notification center via the CP960 conference phone:

1. Swipe down from the top of the screen to enter the notification center.
2. Tap the desired conference notification to join the conference.

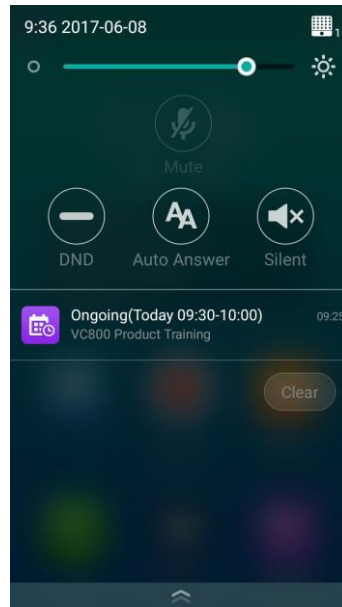

Dialing into a Scheduled Conference

If you schedule a conference or you are invited to a scheduled conference, you can obtain the conference information in following ways:

- Invitee will receive an email, which includes the IP address, conference ID and conference password.

Hello,
2529 invites you to join video conference!

Subject: VC800 Product Training
Time: 2017-06-08 09:30:00 ~ 2017-06-08 10:00:00 (UTC+08:00)
Location : 234234
ID: 61089
Password: 749396

The way to join conference:

- 1) One-button to join conference from Yealink VC device which receives conference reminder;
- 2) The device which has registered YMS account, please follow the voice prompt to enter conference ID 61089 & password 749396 , and end with # key;
- 3) The device which hasn't registered YMS account, please dial 10.2.62.200 first, then follow the voice prompt to enter conference ID 61089 & password 749396, and end with # key;
- 4) To join from a SIP device, please dial 61089**749396@10.2.62.200 and join the conference.
- 5) To join from a H.323 device, please dial 10.2.62.200##61089**749396 and join the conference.

Description:
Do not be late

- VC800 video conferencing system will display conference information, which includes the conference ID and conference password. For more information, refer to [Viewing Conference Schedules](#) on page 143.
- Contact the conference participants.

To dial into the scheduled conference, do one of the following:

- If you have registered a YMS account and you are invited to join the scheduled conference, you can dial the conference ID to join the conference.

Obtain the conference information from your VC800 video conferencing system or your email address.

- If you have registered a YMS account but you are not invited to join the scheduled conference, you can dial the conference ID, and then enter conference password to join the conference.

Obtain the conference information from the other conference participants.

- If you do not register a YMS account, you can dial IP address of the server, and then enter conference ID and conference password to join the conference.

Obtain the conference information from the other conference participants.

- To join from a SIP device, please dial conference ID** conference password@IP address of the server.

Obtain the conference information from your email address other conference participants.

- To join from a H.323 device, please dial IP address of the server ##conference ID**conference password.

Obtain the conference information from your email address other conference participants.

Note

If the system fails to join the scheduled conference, please refer to [General Issues](#) on page 186.

Applying for Speaking



When you schedule a video conference using the Yealink Meeting Server or Microsoft Outlook software, there are two modes for video conference: **Discussion mode** and **Training mode**. For more information, refer to [Yealink Meeting Server User Guide](#).

In **Discussion mode** conference, participants can speak freely.

In **Training mode** conference, all guests are muted automatically except the moderator (or the organizer). Guests need to wait for the moderator to appoint lecturers. If guests want to speak, they should apply for speaking. Only when the moderator allows the application, can they speak freely.

To apply for speaking via the remote control:

1. When enter the **Training mode** conference, muted participants' display device prompts: "Please press  to apply for speaking" in first 30 seconds.

2. Press  on the remote control.
The applicant's display device prompts "  Apply for speaking".

To apply for speaking via the CP960 conference phone:

1. When enter the **Training mode** conference, do one of the following to apply for speaking:
 - Tap  on the CP960's touch screen.
 - Tap mute key on the CP960 conference phone.
 - Tap mute key on the CPW90 Wireless Expansion Mic.
 - Tap mute key on the CPE90 Wired Expansion Mic.
 The touch screen prompts "Apply to speak, please wait".

Processing the Application

If you are the moderator (or an organizer) of video conference in training mode, you can allow or refuse the applicant to speak via the CP960 conference phone.

To process application via the CP960 conference phone:

1. Do one of the following:
 - Tap **Allow** to allow the applicant to speak.

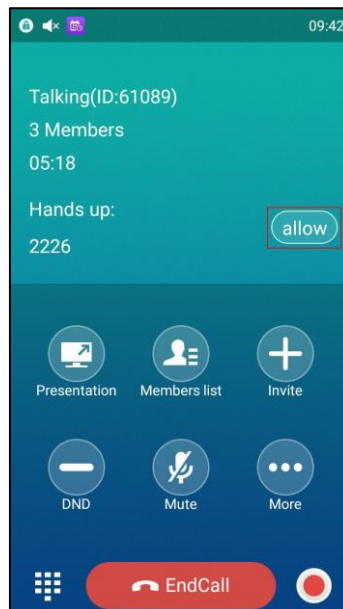

- Tap  during a call.

Tap  to allow the applicant to speak or tap **Clear handup** to clear all request.

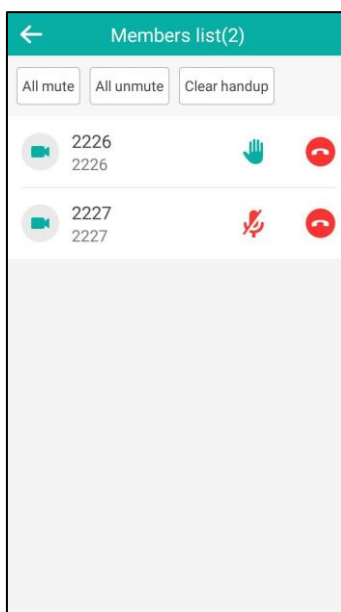

Meet Now

When you log into the VC800 system using an YMS account, you can use **Meet Now** feature.

Initiating a Meet Now Conference

You can initiate a meet now conference at any time.

In meet now conference, if you receive a call from YMS contacts, a reminder will prompt that you can allow or refuse the contact to join the conference.

To initiate the meet now conference via the remote control:

1. Select  (**Meet Now** menu).
The conference is initiated successfully.

To initiate the meet now conference via the CP960 conference phone:

1. Tap  .
The conference is initiated successfully.

Dialing to Join a Meet Now Conference

You can dial to join a meet now conference that is initiated by others. And you can obtain the conference information from the conference participants.

To dial to join a meet now conference:

1. Do one of the following:
 - If you register a YMS account, you can dial the conference ID to join the conference.

- Dial conference ID**@IP address of the server to join the conference.
- Dial IP address of the server ##conference ID to join the conference.





YMS Video Conference Management

This chapter introduces how to manage YMS video conference (scheduled conference and meet now conference).

Inviting Conference Participants

During the YMS video conference, you can use the remote control or CP960 conference call to invite other YMS contacts to join the conference.



To invite participants during a YMS video conference via the remote control:

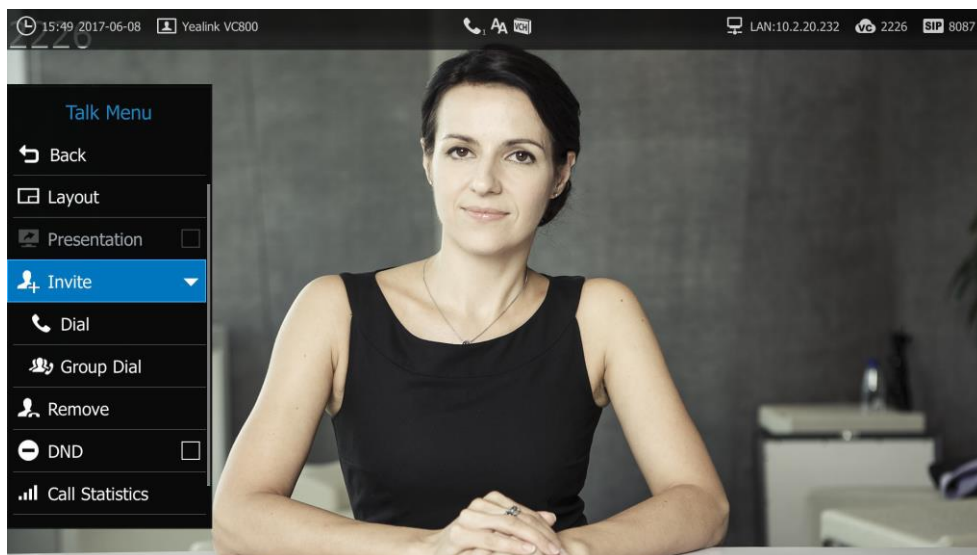

1. Press  or  to open **Talk Menu**.
2. Press  or  to scroll to **Invite** and then press  to expand the menu.



3. Do one of the following:
 - If you select **Dial**, enter a YMS account, and then dial out.
 - If you select **Group Dial**, check the desired YMS contacts' checkboxes, and then press  to select **Start conference call**.
4. Repeat above steps until all participants have been added.

To invite participants during a YMS video conference via the CP960 conference phone:

1. Tap .
2. Do one of the following:
 - If you tap , tap the desired YMS contacts, and then tap  to dial out.





- If you tap  , enter a YMS account, and then tap **Add Members**. Repeat this step to add more members, and then tap  to dial out.

Note If you fail to send invitation, you can re-send the invitation according to the prompt or contact your administrator.

Removing Conference Participants

If you are the organizer/moderator of a YMS video conference, you can remove conference participants via the remote control or CP960 conference phone.

To remove conference participants via the remote control:

1. Press  or  to open **Talk Menu**.
2. Press  or  to scroll to **Remove** and then press  to enter the submenu.

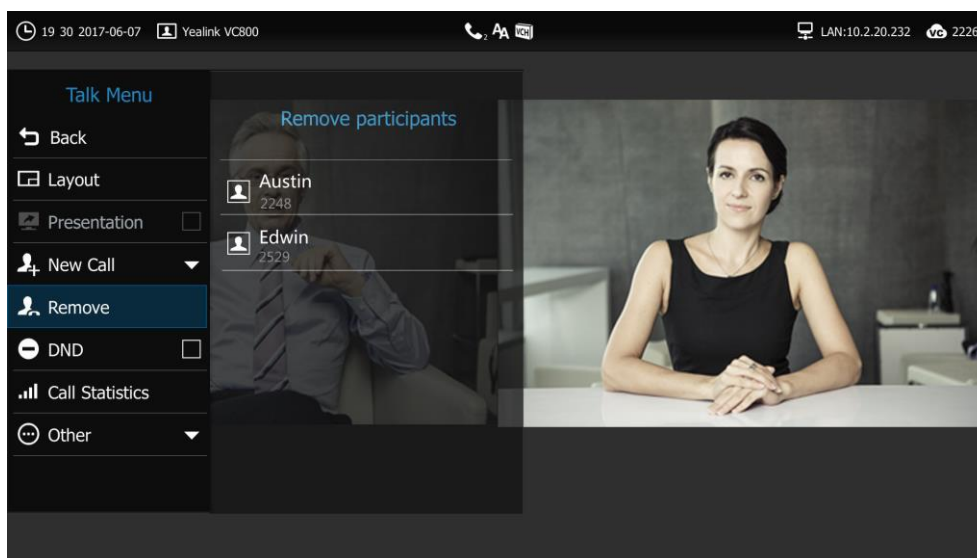

3. Select a member that you want to remove, and then press .

To remove conference participants via the CP960 conference phone:

1. Tap  during a call.
The touch screen displays all participants.

2. Tap  after the participant that you want to remove.

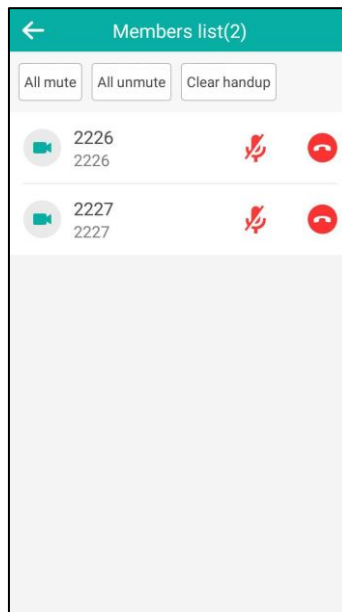

Muting or Unmuting All Conference Participants

If you are the organizer/moderator of a YMS video conference, you can use the CP960 conference phone to mute or unmute all conference participants except for yourself.

In scheduled conference, conferences participants muted by an organizer/moderator cannot unmute themselves.

To mute all conference participants via the CP960 conference phone:

1. Tap  during a call.
The touch screen displays all participants.

2. Tap **All mute** to mute all participant.

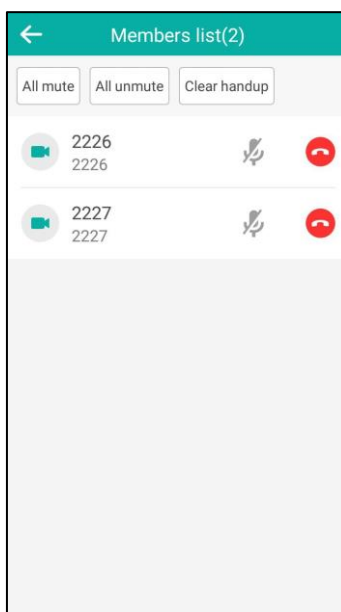

To unmute all conference participants via the CP960 conference phone:

1. Tap  during a call.
The touch screen displays all participants.
2. Tap **All unmute** to unmute all participant.

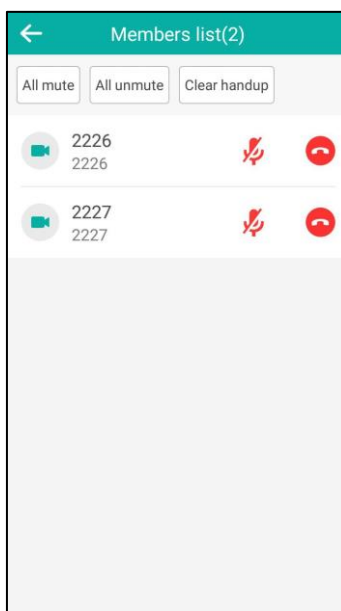



Muting or Unmuting a Conference Participant

If you are the organizer/moderator of a YMS video conference, you can use the CP960 conference phone to mute or unmute any conference participants.



In scheduled conference, conferences participants muted by an organizer/moderator cannot

unmute themselves.

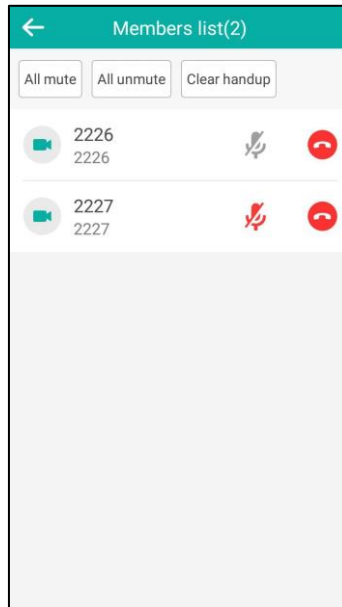

To mute a conference participant via the CP960 conference phone:

1. Tap  during a call.
The touch screen displays all participants.
2. Tap  after the participant that you want to mute.





The participant is muted, and the  icon changes to .

To unmute a conference participant via the CP960 conference phone:

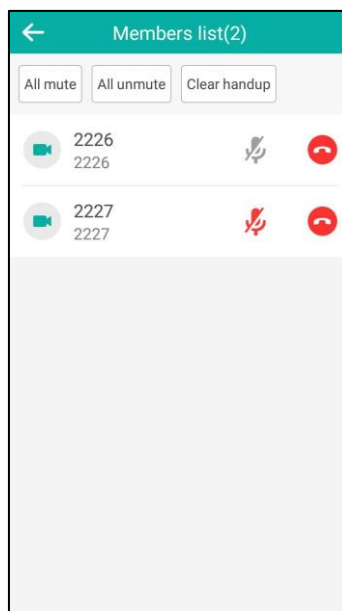
1. Tap  during a call.
The touch screen displays all participants.
2. Tap  after the participant that you want to unmute.



The participant is unmuted, and the  icon changes to .

Leaving the Conference

All participants can use the remote control or CP960 conference phone to leave the conference at any moment.

To leave the conference via the remote control:

1. Press .
2. Select **Leave, others keep going**, and then press .

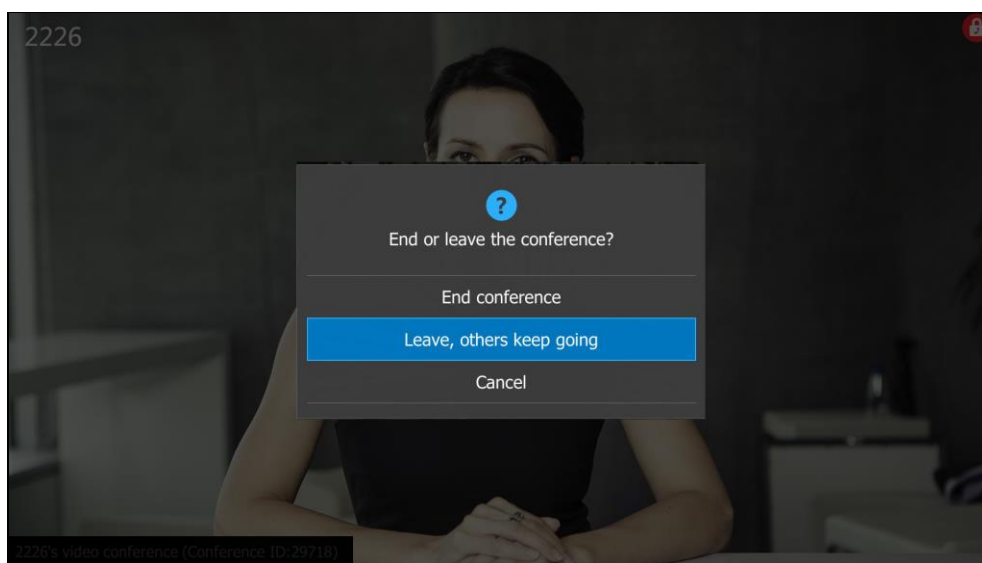

Other participants remain connected.

To leave the conference via the CP960 conference phone:

1. Tap **EndCall**.
2. Tap **Leave, others keep going**.

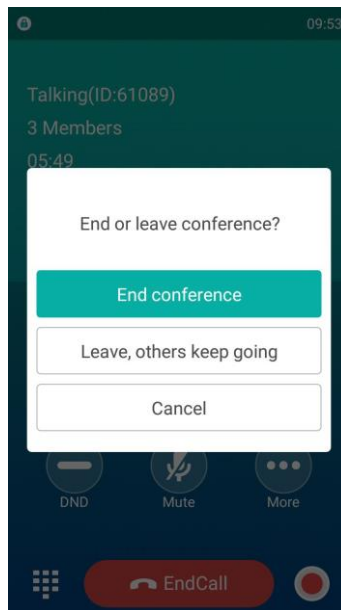

Other participants remain connected.



Ending the Conference

If you are the organizer/moderator of a YMS video conference, you can use the remote control or CP960 conference phone to end the conference.

To end the conference via the remote control:

1. Press .
2. Select **End conference**, and then press .

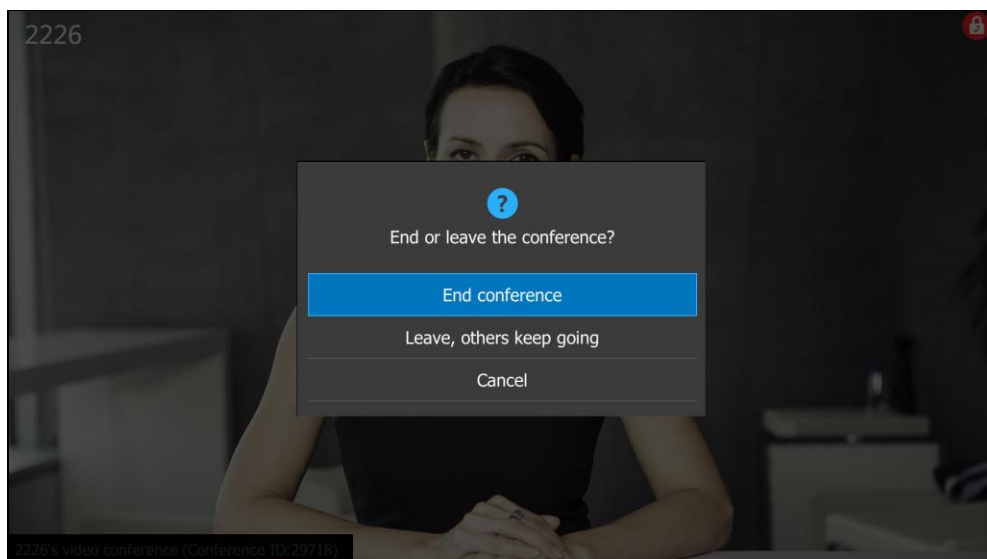

To end the conference via the CP960 conference phone:

1. Tap **EndCall**.

2. Tap **End conference**.

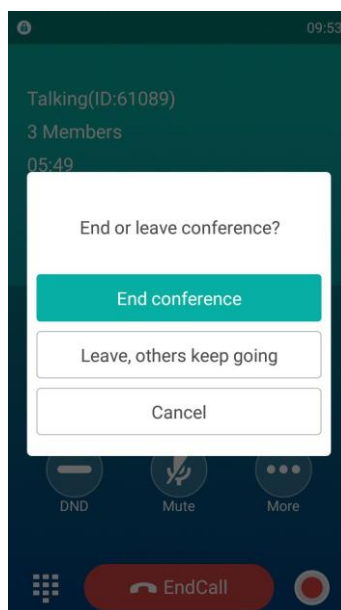

Using the StarLeaf Cloud Platform



You can log into the StarLeaf Cloud platform.

When you place a call using the StarLeaf Cloud account, you can:

- Call the other StarLeaf Cloud account to establish a point to point call.
- Call the conference ID to join the Virtual Meeting Rooms.
- Call between StarLeaf Cloud account and Microsoft Skype for Business/Lync account.



Dialing StarLeaf Cloud Numbers

To dial StarLeaf Cloud numbers via the remote control:

1. Select  (**Dial** menu) or press  to enter the pre-dialing screen.

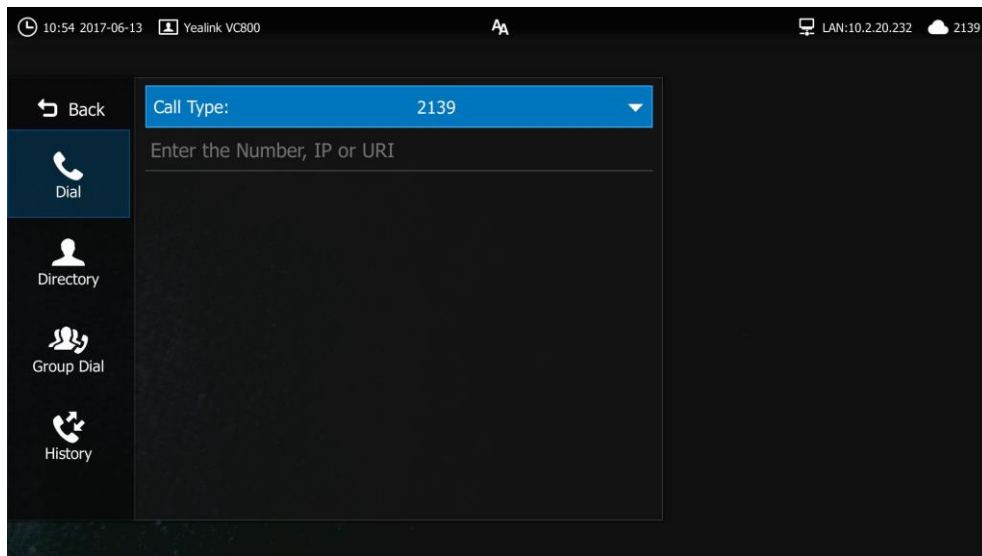
2. Select StarLeaf Cloud number from the pull-down list of **Call Type** before calling.



3. Enter a StarLeaf Cloud number using the keypad or the on-screen keyboard.
4. Press ► to select  (video call) or  (voice call), and then press  to dial out the number.

To dial StarLeaf Cloud numbers via the CP960 conference phone:

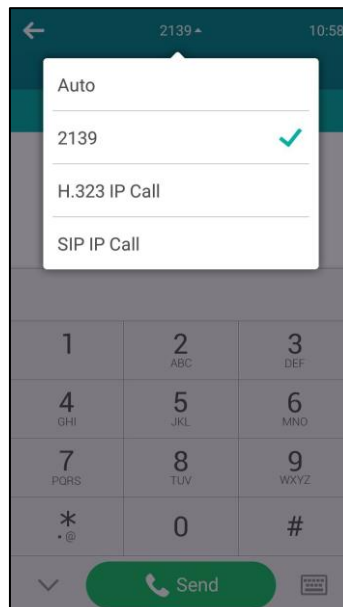

1. Tap .
2. Tap the **Auto** field.
3. Tap StarLeaf Cloud number in the pop-up dialog box.







4. Enter the desired YMS account.
5. Tap **Send**.

Joining the StarLeaf Meeting

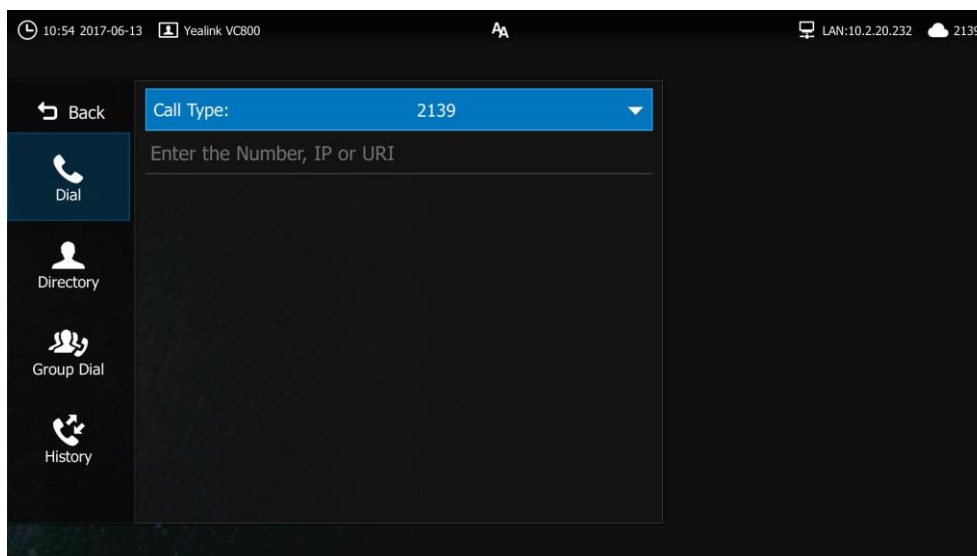
To join the StarLeaf meeting via the remote control:

1. Select  (**Dial** menu) or press  to enter the pre-dialing screen.
2. Select StarLeaf Cloud number from the pull-down list of **Call Type** before calling.



3. Enter a conference ID using the keypad or the on-screen keyboard.
4. Press  to select  (video call) or  (voice call), and then press  to dial out the number.

To join the StarLeaf meeting via the CP960 conference phone:

1. Tap  .
2. Tap the **Auto** field.

3. Tap the StarLeaf Cloud number in the pop-up dialog box.

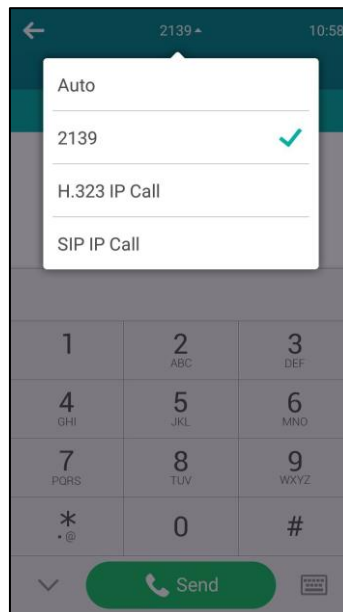

4. Enter a conference ID.
5. Tap **Send**.

Using the Zoom Cloud Platform

You can log into the Zoom Cloud platform, and join the Zoom meeting.



Joining the Zoom Meeting

To join the Zoom meeting via the remote control:

1. Select  (**Dial** menu) or press  to enter the pre-dialing screen.

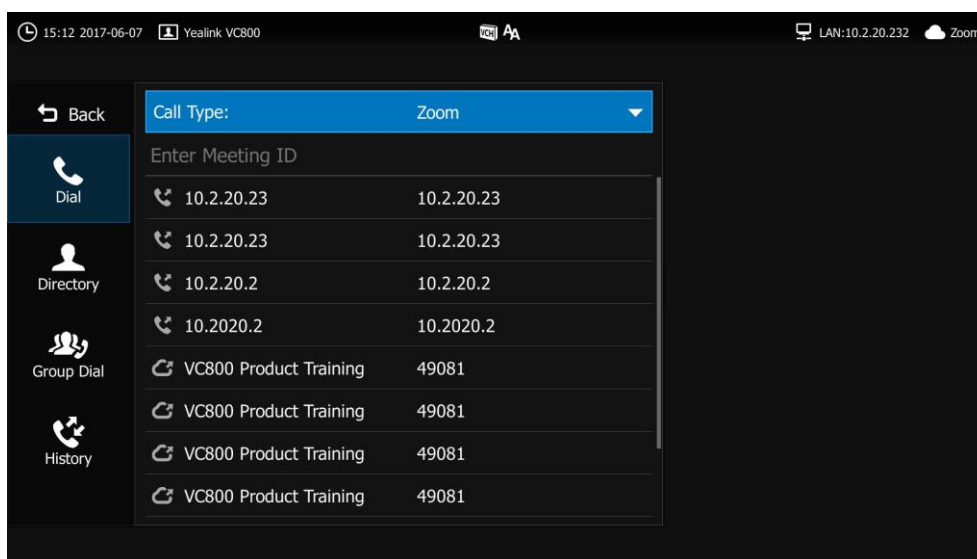
2. Select **Zoom** from the pull-down list of **Call Type** before calling.



3. Enter a conference ID using the keypad or the on-screen keyboard.
4. Press ► to select  (video call) or  (voice call), and then press  to dial out the number.
5. Follow the voice prompt to join the Zoom meeting.

To join the Zoom meeting via the CP960 conference phone:

1. Tap .
2. Tap the **Auto** field.
3. Tap **Zoom** in the pop-up dialog box.

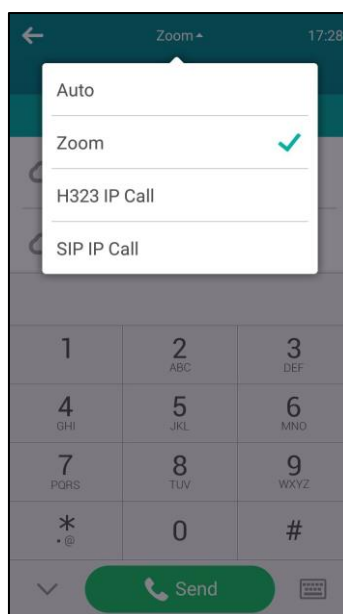

4. Enter a conference ID.
5. Tap **Send**.

- Follow the voice prompt to join the Zoom meeting.

Note



If you enter nothing or enter wrong information, you can still be sent to the Zoom welcome screen.

Using the BlueJeans Cloud Platform





You can log into the BlueJeans Cloud platform, and join the BlueJeans meeting.

Joining the BlueJeans Meeting

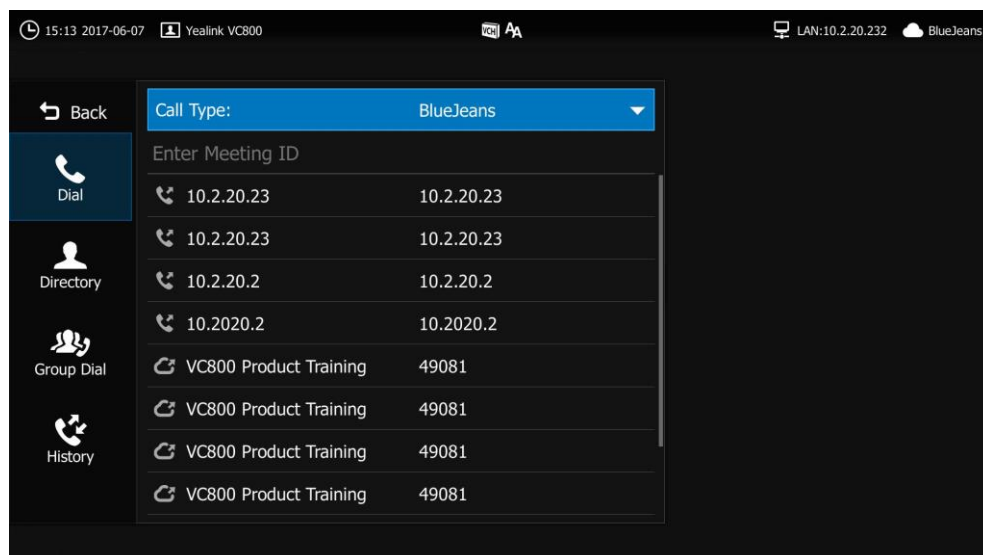
To join the BlueJeans meeting via the remote control:

- Select  (**Dial** menu) or press  to enter the pre-dialing screen.
- Select **BlueJeans** from the pull-down list of **Call Type** before calling.



- Enter a conference ID using the keypad or the on-screen keyboard.
- Press  to select  (video call) or  (voice call), and then press  to dial out the number.
- Follow the voice prompt to join the BlueJeans meeting.

To join the bluejeans meeting via the CP960 conference phone:

- Tap .
- Tap the **Auto** field.

3. Tap **BlueJeans** in the pop-up dialog box.

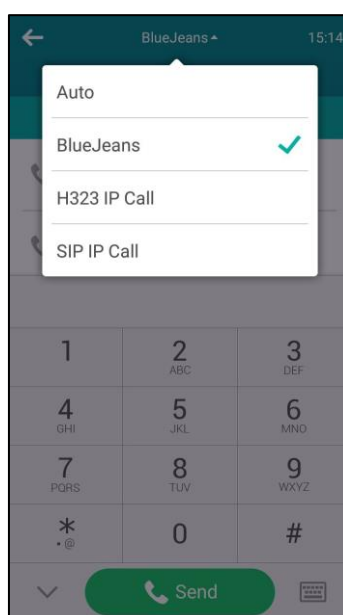

4. Enter a conference ID.
5. Tap **Send**.
6. Follow the voice prompt to join the BlueJeans meeting.

Note If you enter nothing or enter wrong information, you can still be sent to the BlueJeans welcome screen.

Using the Pexip Platform



You can register the Pexip account.

When you place a call using the Pexip account, you can:

- Call the device alias to establish a point to point call.
- Call the aliases to join the Virtual Meeting Rooms, Virtual Auditoriums or Virtual Receptions.
- Call between Pexip account and Microsoft Skype for Business/Lync account.



Dialing Pexip Alias

To dial Pexip alias via the remote control:

1. Select  (**Dial** menu) or press  to enter the pre-dialing screen.

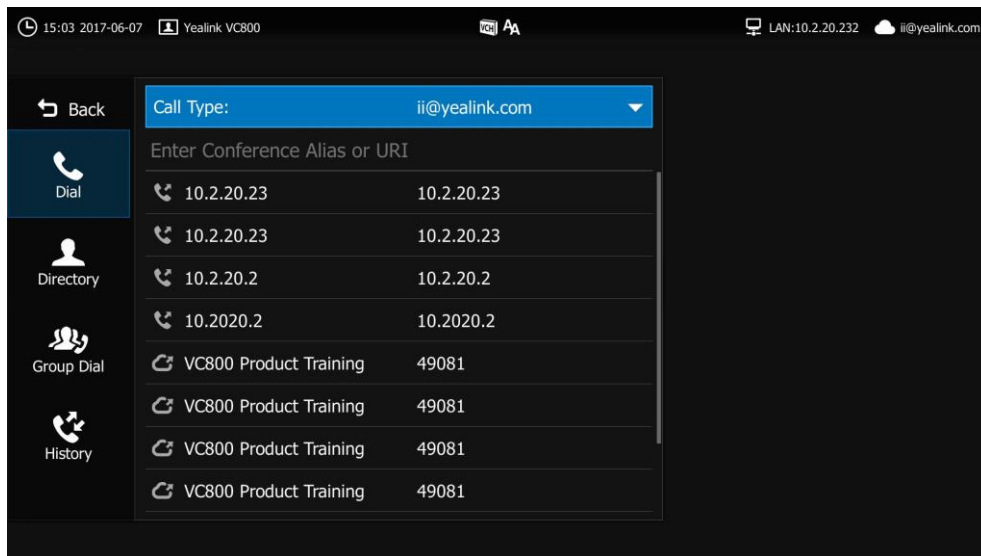
- Select the registered alias from the pull-down list of **Call Type** before calling.



- Enter the device alias or URI using the keypad or the on-screen keyboard.
- Press ► to select  (video call) or  (voice call), and then press  to dial out the number.

To dial Pexip alias via the CP960 conference phone:

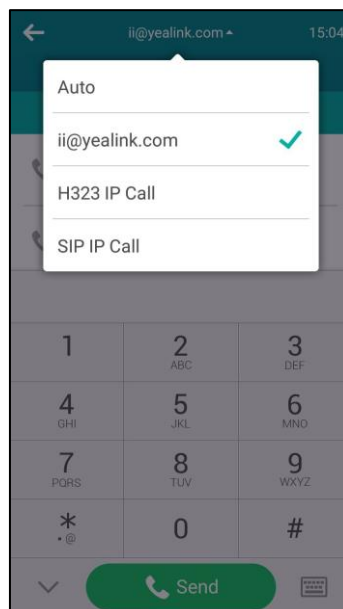

- Tap .
- Tap the **Auto** field.
- Tap the registered alias in the pop-up dialog box.







- Enter the device alias or URI.
- Tap **Send**.

Joining the Pexip Meeting

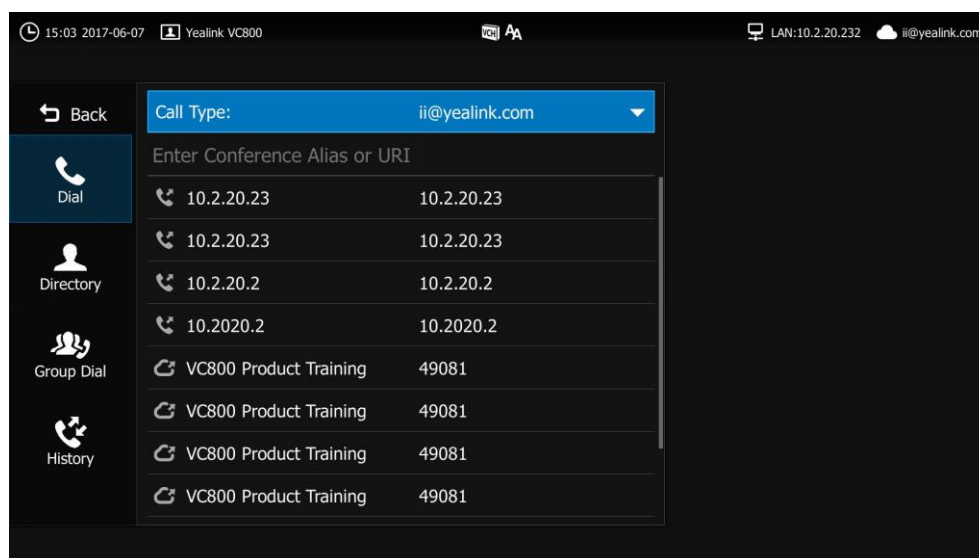
To join the Pexip meeting via the remote control:

1. Select  (**Dial** menu) or press  to enter the pre-dialing screen.
2. Select the registered alias from the pull-down list of **Call Type** before calling.



3. Enter the conference alias or URI using the keypad or the on-screen keyboard.
4. Press  to select  (video call) or  (voice call), and then press  to dial out the number.
5. Follow the voice prompt to join the Pexip meeting.

To dial Pexip alias via the CP960 conference phone:

1. Tap  .
2. Tap the **Auto** field.

3. Tap the registered alias in the pop-up dialog box.

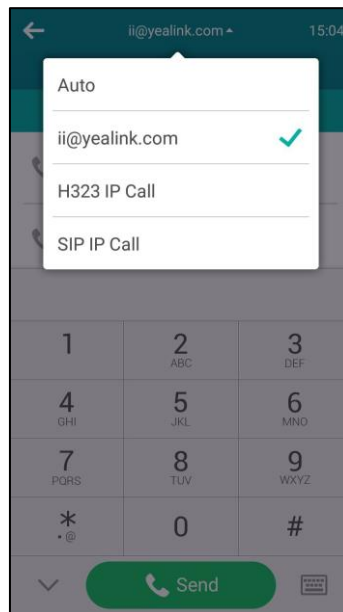

4. Enter the device alias or URI.
5. Tap **Send**.

Using the Mind Platform

You can log into the Mind platform, and join the Mind meeting.



Joining the Mind Meeting

To join the Mind meeting via the remote control:

1. Select  (**Dial** menu) or press  to enter the pre-dialing screen.

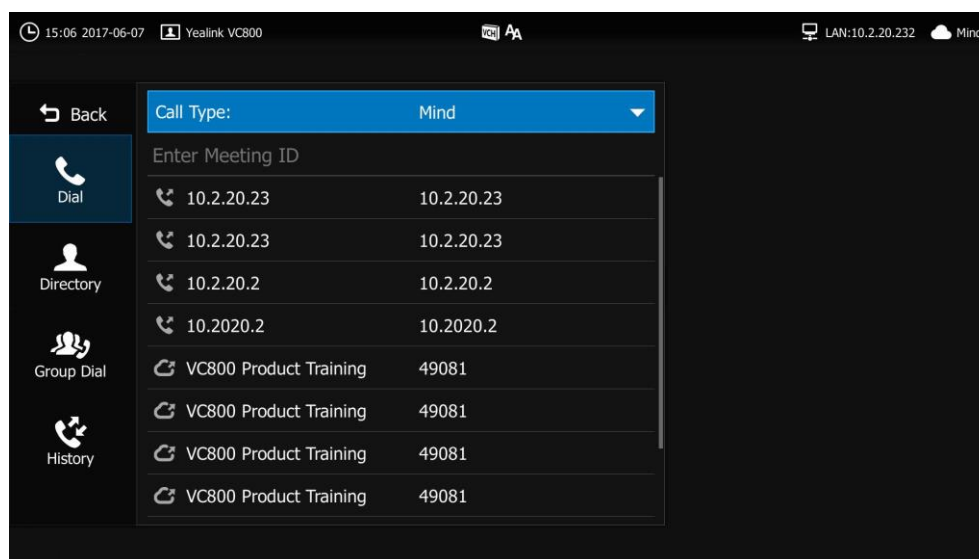
2. Select **Mind** from the pull-down list of **Call Type** before calling.



3. Enter a conference ID using the keypad or the on-screen keyboard.
4. Press ► to select  (video call) or  (voice call), and then press  to dial out the number.
5. Follow the voice prompt to join the Mind meeting.

To join the Mind meeting via the CP960 conference phone:

1. Tap .
2. Tap the **Auto** field.
3. Tap **Mind** in the pop-up dialog box.

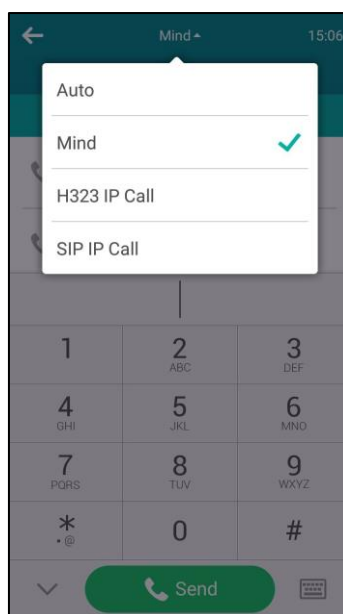

4. Enter a conference ID.
5. Tap **Send**.

6. Follow the voice prompt to join the Mind meeting.

Using the Custom Platform

When you register a custom account, you can use the corresponding platform feature.

Using the CPW90 Wireless Expansion Mic

This chapter provides basic operating instructions for the CPW90 Wireless Expansion Mic. Topics include:

- [LED Instructions](#)
- [Charging the CPW90](#)
- [Turning the CPW90 On or Off](#)
- [Registering CPW90 with the CP960 Conference Phone](#)
- [Viewing CPW90 Information](#)
- [Muting or Unmuting the CPW90](#)
- [Finding the Registered CPW90](#)
- [Working Frequency](#)

If you require additional information or assistance with your new phone, contact your system administrator.

LED Instructions

Battery indicator LED on the CPW90 wireless expansion mic:

LED Status	Description
Solid green for one second and then off	The CPW90 is turned on.
Solid green for 3 seconds and then off	The CPW90 is in the idle mode.
Solid green	The CPW90 is fully charged.
Solid red	The CPW90 is being charged.
Fast flashing red 3 times and then off	The battery capacity is too low to turn on the CPW90.
Slowly flashing red	The battery capacity is less than 10%.
Off	If you tap the mute button, the battery indicator LED on the CPW90 is still off, this means the CPW90 is turned off.

Mute indicator LED on the CPW90 wireless expansion mic:

LED Status	Description
Solid green	The CP960 conference phone enters the pre-dialing screen.

LED Status	Description
	The CP960 conference phone is in a call and unmuted.
Slowly flashing red	The CP960 conference phone is receiving an incoming call.
Solid red	The CP960 conference phone is muted.
Fast flashing yellow	The CPW90 is in the registration mode.
Slowly flashing yellow	The CPW90 has registered with the CP960 conference phone, but the CPW90 is out of range.
	The CPW90 has registered with the CP960 conference phone, but the CP960 is turned off.
Flashing red and green alternately	The CP960 conference phone is searching for the CPW90 which has registered with it.
Off	The CPW90 is in the idle mode.

Placing the CPW90

The CPW90 has a rubber pads on its base to prevent it from sliding. You can place the CPW90 on a conference table. Do the following to ensure optimal voice quality:

- For registering to CP960 conference phone successfully, make sure the CPW90 is less than 20 meters distant from the CP960 conference phone.
- Place the CPW90 on a stable surface and keep it away from obstacles so that it can effectively pick up sounds.

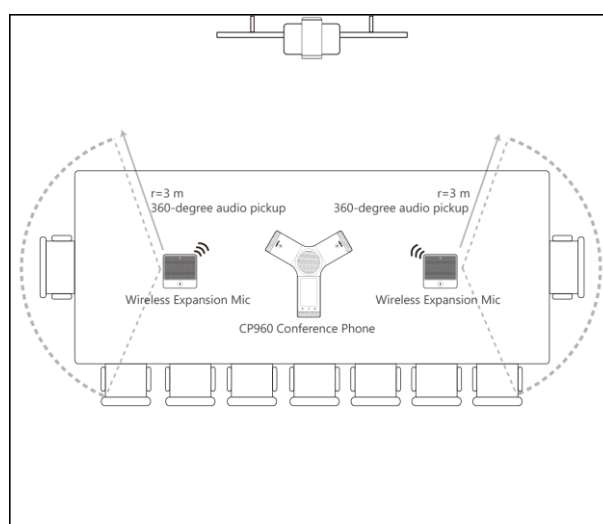

Charging the CPW90

If the CPW90 is not in use, we recommend you to charge the CPW90 even when the battery is full.

To charge the CPW90:

1. Put the CPW90 on the charging cradle.
2. Connect the micro USB port on the charging cradle to the USB port on the CP960 using a 0.3m USB cable.

During charging, the battery LED indicator on the CPW90 illuminates solid red. When the battery capacity reaches 100%, the battery LED indicator on the CPW90 will illuminate solid green.

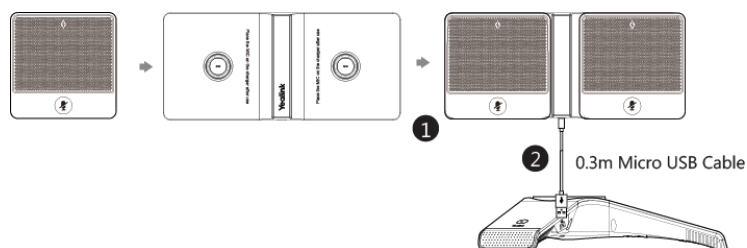
**Note**

If it is the first time you use the CPW90, you need to fully charge the CPW90 for normal use.

Turning the CPW90 On or Off

After the CPW90 starts, it registers with the CP960 conference phone automatically. You can turn off CPW90 if it is not in use for a long period of time.

To turn on the CPW90:

1. Do one of the following:
 - Put the CPW90 on a charging cradle, the CPW90 will turn on automatically.
 - Long tap the mute button on the CPW90 for 3 seconds.

To turn off the CPW90:

1. Long tap the mute button on the CPW90, until the battery indicator LED on the CPW90 illuminates solid red for 3 seconds and then goes out.

Registering CPW90 with the CP960 Conference Phone

If the CPW90 has registered with the CP960 conference phone, you can skip this chapter. If the CPW90 is not registered with the CP960 conference phone, you should register the CPW90 with the CP960 conference phone manually. So that the CPW90 can work as expansion microphone of the CP960 conference phone.

To register the CPW90 to the CP960 conference phone:

1. Do the following on the CP960 conference phone:

Tap  -> **Wireless Microphone.**

Tap **+** to search for a CPW90.

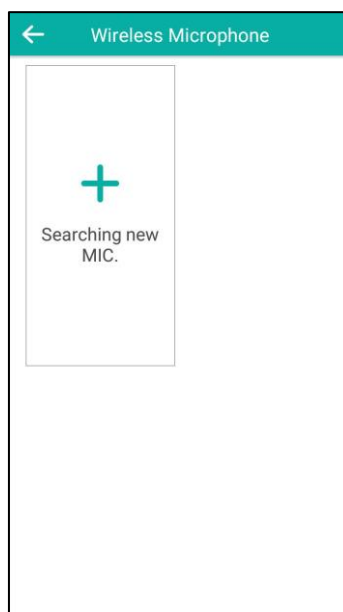

2. Turn on the CPW90.

The CPW90 enters the registration mode automatically. And the mute indicator LED on the CPW90 fast flashes yellow.

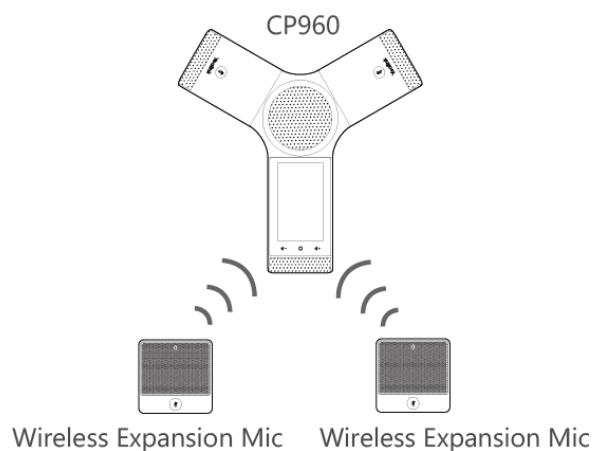

The CPW90 registers with the CP960 conference phone automatically. If the registration is successful, the mute indicator LED on the CPW90 goes out and the touch screen of CP960 conference phone prompts the CPW90 information: battery, work time and standby time.

Note

You can register up to two wireless expansion microphones to a CP960 conference phone.

To deregister the CPW90:

1. Tap  -> **Wireless Microphone**.
2. Select the desired mic, and then tap **Detail**.

3. Tap **Unbind** to deregister the CPW90.

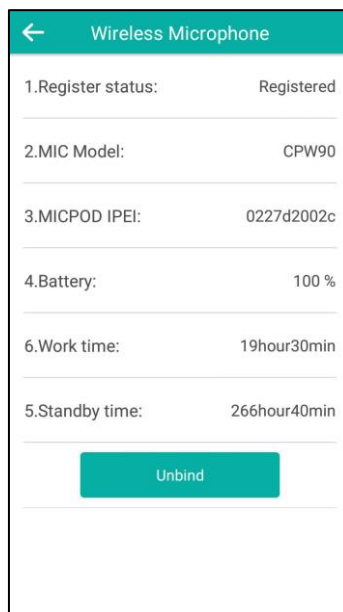

The CPW90 can only be registered with one CP960 conference phone. If you want to register the CPW90 to another CP960 conference phone, the CPW90 will be deregistered from the previous CP960 conference phone automatically.

To register the CPW90 with another CP960 conference phone:

1. Do the following on another CP960 conference phone:

Tap  -> **Wireless Microphone**.

Tap  to search for a CPW90.

2. Put the CPW90 on the charging cradle and make sure it is charging.

3. Long tap the mute button on the CPW90 for 5 seconds.

The CPW90 enters the registration mode. And the mute indicator LED on the CPW90 fast flashes yellow.

4. The CPW90 registers with the CP960 conference phone automatically.

Viewing CPW90 Information







When the CP960 conference phone and CPW90 wireless expansion mic are connected successfully, you can view CPW90 status via the remote control, CP960 conference phone or web user interface.

Available information of CPW90 includes:

- Register Status
- MIC Version
- MIC Model
- MICPOD IPEI

- Battery Status
- Work Time(estimated working time)
- Standby Time (estimated standby time)

To view the CPW90 information via the remote control:

1. Select  (**More** menu).
2. Press  or  to scroll to **Status** and then press  to enter submenu.
3. Press  or  to scroll to **Wireless Micpod** and then press  .

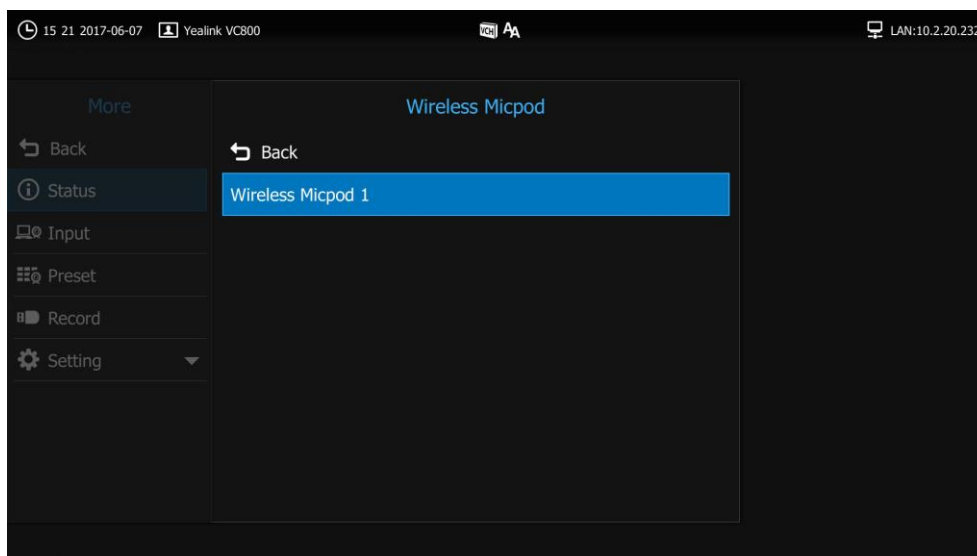

4. Select the desired wireless micpod to view details.

To view the CPW90 information via the remote control:

1. Tap  -> **Wireless Microphone**.
2. Tap **Detail** to view details.

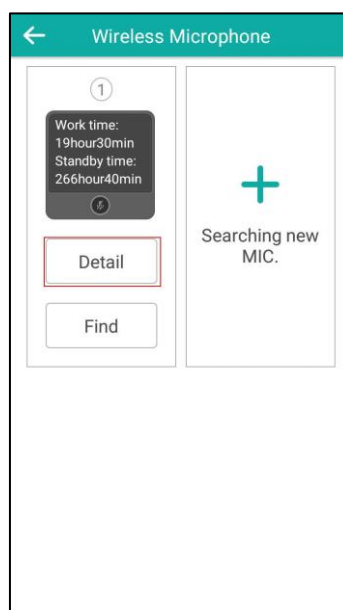

CPW90 information can be viewed via the web user interface at the path **Status-> Wireless Micpod**.

Muting or Unmuting the CPW90

If the CP960 conference phone is in a call, you can tap the mute button on the CPW90 to mute or unmute the CP960 conference phone.

Finding the Registered CPW90

You can find the CPW90 which has registered with your CP960 conference phone.

To find the registered CPW90 via the CP960 conference phone:

1. Tap  -> **Wireless Microphone**.
2. Select the desired mic, and then tap **Find**.

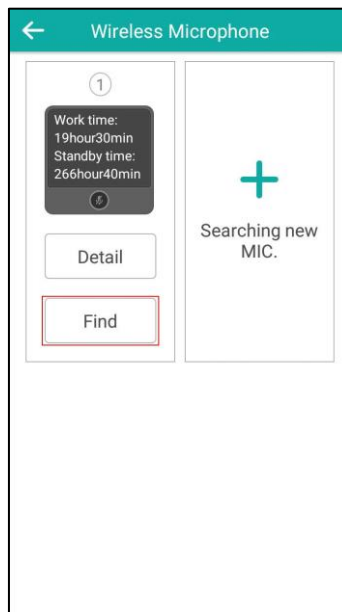

The mute indicator LED on the CPW90 flashes red and green alternately.

Working Frequency

For reference, the Frequency/Channels of CPW90 used in each Region are tabulated below:

Freq (MHz)	RF Carrier Index (DECT tester Numbering)						
	EU	Taiwan	US	LA	Korea	Brazil	Japan
1881.792	9	9					
1883.520	8	8					

Freq (MHz)	RF Carrier Index (DECT tester Numbering)						
	EU	Taiwan	US	LA	Korea	Brazil	Japan
1885.248	7	7					
1886.976	6	6					
1888.704	5	5					
1890.432	4	4					
1892.160	3	3					
1893.888	2	2					
1895.616	1						4(F1)
1897.344	0						3(F2)
1899.072							2(F3)
1900.800							1(F4)
1902.528							0(F5)
1904.256							
1905.984							
1907.712							
1909.440							
1911.168						4	
1912.896				9		3	
1914.624				8		2	
1916.352				7		1	
1918.080				6		0	
1919.808				5			
1921.536			4	4			
1923.264			3	3			
1924.992			2	2			
1926.720			1	1			
1928.448			0	0			
1787.616					8		
1789.344					7		
1791.072					6		

Using the CPE90 Wired Expansion Mic

This chapter provides basic operating instructions for the CPE90 Wired Expansion Mic. Topics include:

- [Placing the CPE90](#)
- [Muting or Unmuting the CPE90](#)

If you require additional information or assistance with your new phone, contact your system administrator.

Placing the CPE90

The CPE90 has a rubber pads on its base to prevent it from sliding. You can place the CPE90 on a stable surface and keep it away from obstacles so that it can effectively pick up sounds.

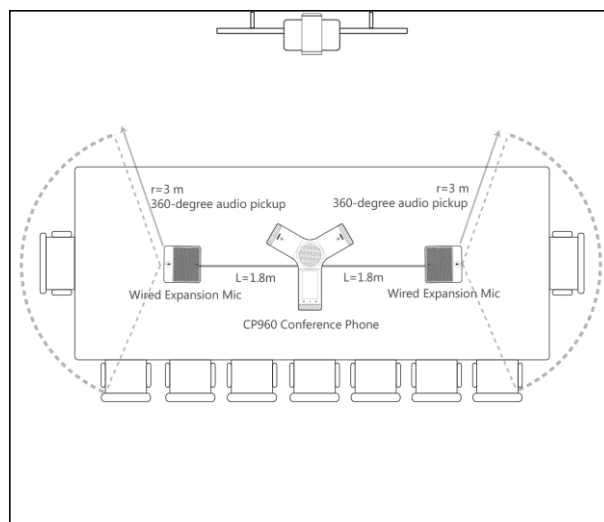

Muting or Unmuting the CPE90

If you connect the CPE90 wired expansion mic to the CP960 conference phone to expand the audio range, you can tap  on the CPE90 to mute or unmute the local voice.

Troubleshooting

This chapter provides general troubleshooting information to help you solve problems you might encounter when using your VC800 system. If you require additional information or assistance with your new phone, contact your system administrator.





Ensure the system has not been physically damaged when experiencing a problem. Check whether the cables are loose and the connections are correct and secure. These are common causes of problems.

System Diagnostics

Diagnostic menus include:

- **Audio Diagnose:** Check whether the audio output device can pick up voice and play audio normally.
- **Camera Diagnose:** Check whether the camera can pan and change focus normally.
- **Ping:** Check whether the network between the local and the remote system is connected.
- **Trace Route:** Display the route (path) and measure transit delays of packets across an Internet Protocol (IP) network.

Audio Diagnose:

1. Select  (**More** menu).
2. Press ▲ or ▼ to scroll to **Setting** and then press  to expand the menu.
3. Press ▲ or ▼ to scroll to **Diagnose** and then press  to enter submenu.
4. Press ▲ or ▼ to scroll to **Audio Diagnose** and then press .

5. Speak into the microphone.

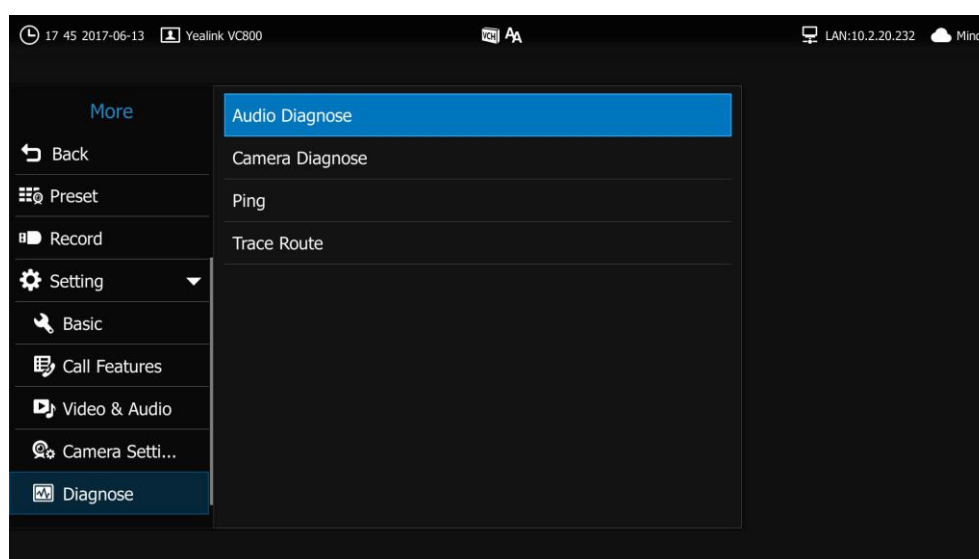



6. Check whether the microphone can pick up audio normally.
7. If the microphone picks up audio and plays back audio normally, it means that the audio works well.
8. Press **OK** to stop audio diagnostics.

Camera Diagnose:

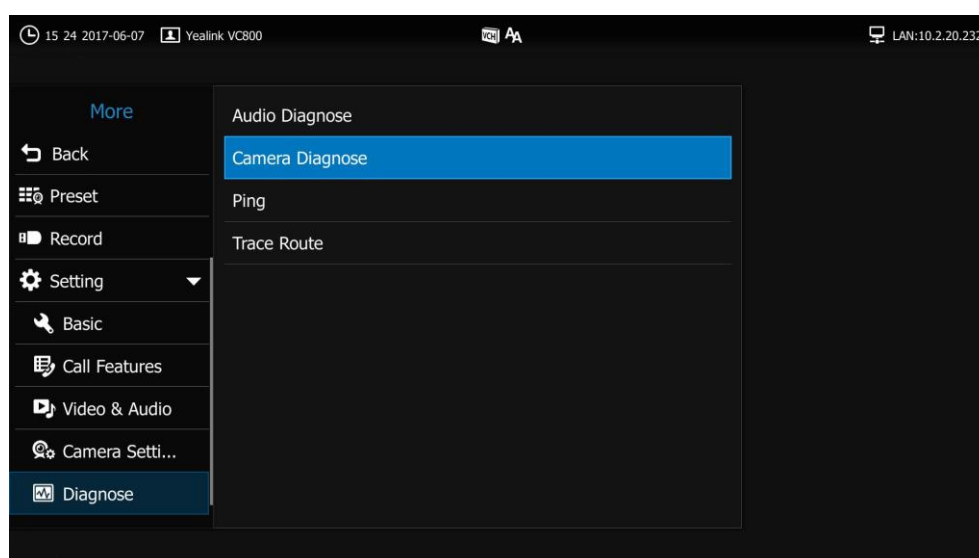











1. Select **More** (More menu).
2. Press **▲** or **▼** to scroll to **Setting** and then press **OK** to expand the menu.
3. Press **▲** or **▼** to scroll to **Diagnose** and then press **▶** to enter submenu.
4. Press **▲** or **▼** to scroll to **Camera Diagnose** and then press **OK**.



5. Press **▲** or **▼** to adjust the camera position.

6. Press  or  to adjust the focus.
7. If the camera can move and zoom normally, it means that the camera is working well.
8. Press  to stop camera diagnostics.

Network diagnosis:

1. Select  (**More** menu).
2. Press  or  to scroll to **Setting** and then press  to expand the menu.
3. Press  or  to scroll to **Diagnose** and then press  to enter submenu.
4. Press  or  to scroll to **Ping** and then press  .
5. Press  or  to scroll to **Start** and then press  .



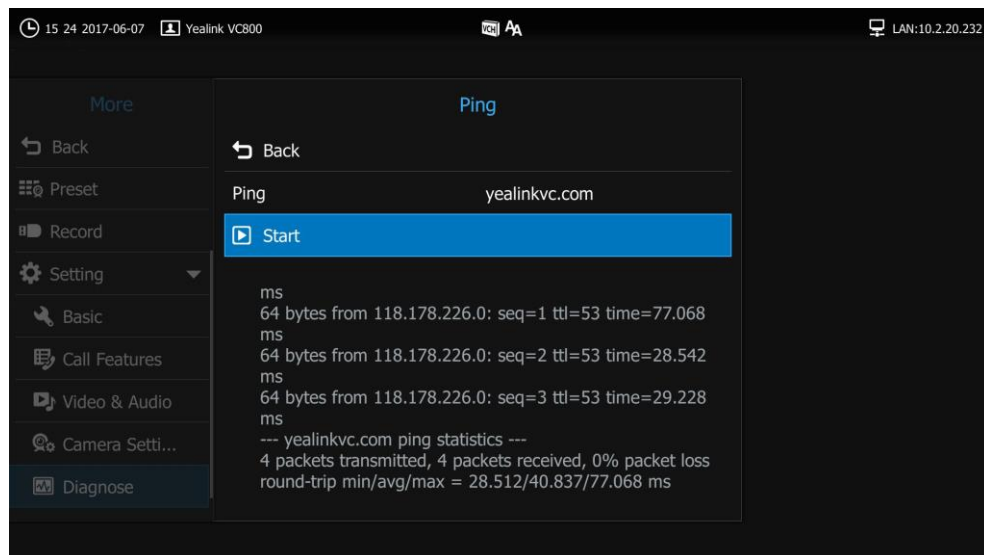









You can also enter other IP address (for example, the IP address of the remote system) in the **Ping** field.



It measures the round-trip time from transmission to reception and reports errors and packet loss. The results of the test include a statistical summary of the response packets received, including the minimum, maximum, and the mean round-trip times.

6. Press  to return to Diagnose menu.

Trace Route:

1. Select  (**More** menu).
2. Press  or  to scroll to **Setting** and then press  to expand the menu.
3. Press  or  to scroll to **Diagnose** and then press  to enter submenu.
4. Press  or  to scroll to **Trace Route** and then press  .
5. Press  or  to scroll to **Start** and then press  .

You can also enter other IP address (for example, the IP address of the remote system) in the **Trace Route** field.

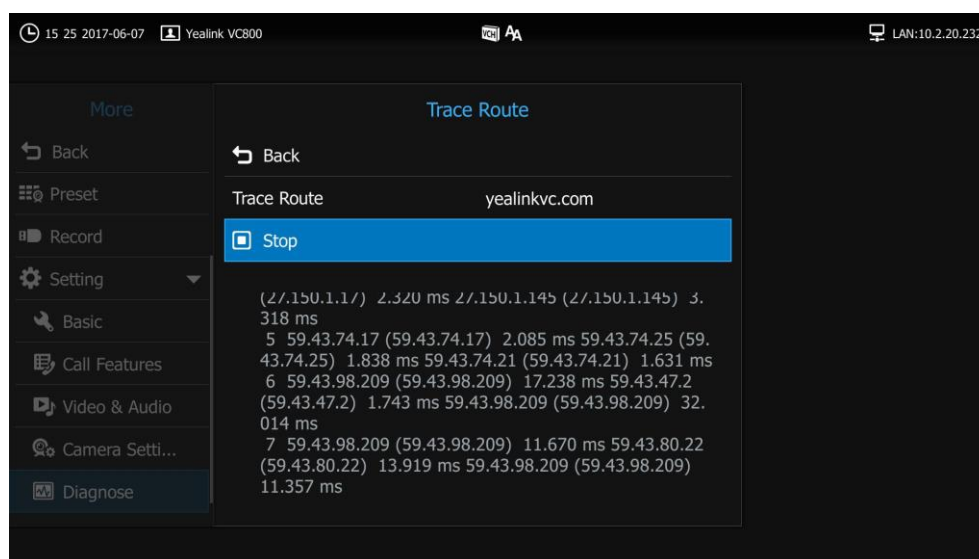

If the test is successful, the VC800 system lists the hops between the system and the IP address you entered. You can check whether congestion happens via the time cost between hops.

6. Press  to return to Diagnose menu.

General Issues

Why can't the system place a call?

- Check the network is available.
- When making a call using an account, check that the account is registered.
- Ensure the remote system supports the same call protocol as the local system. If you want to place a call using another protocol, refer to [Call Protocol](#) on page 84.

Why can't the system receive calls?

- Check the network is available.
- When receiving a call using an account, check that the account is registered.
- Check that DND (Do Not Disturb) mode is deactivated on your system. Refer to [Do Not Disturb \(DND\)](#) on page 112.



Why doesn't the display device display the time and date correctly?

Check whether you have configured the system to obtain the time and date from the SNTP server automatically. If the system fails to connect to the SNTP server, contact your system administrator for more information. You can also configure the time and date manually. For

more information, refer to [Time & Date](#) on page 50.

How to obtain the IP address of the system?

There are three ways to obtain the IP address of the system:

- The IP address of the system is shown on the top right corner of the display device.
- Select  (**More** menu).
Press ▲ or ▼ to scroll to **Status** and then press ► select **Network**.
The display device shows the network information about the system.
- Press  on the CP960 conference phone when the phone is idle and select **Network**.
The CP960's touch screen displays the network information about the system.

Why does the system fail to call the far site?

- Check whether the network of the near site is available.
- Check whether the network of the far site is available.
- Check whether the far site enables the DND feature.
- Check whether the accounts have been registered correctly, and the system uses the appropriate account to call the far site.
- Check whether the local system can ping the IP address of the remote system successfully.
- Ensure that the entered call information is correct.
- Ensure that the called party is powered on.
- Check whether the far site rejects your call.
- Check whether the firewall blocks the inbound traffics from the other site.
- Check whether the far site has already up to maximum call-in limitation.
- If the near site is forced to use encryption, ensure that the far site enables encryption too.
- Ensure that the far site supports the same call protocol as the near site.

Why does the system fail to call the far site via IP address?

- Ensure that the network is connected correctly.
- Ping the IP address of the far site. Contact your system administrator if it fails.

Camera Issues

How to adjust room lighting?

You can alter the environmental lighting and background colors of your environment to obtain the best video quality. If light levels are too low you may consider adding artificial lighting.

Reflected light from pale walls often produces excellent results.

Avoid the following situations:

- Direct sunlight on the display device, the background, or the camera lens which creates harsh contrasts.
- Colored lighting.

Why can't I adjust the camera angle and focus?

- You can adjust the camera when the system is idle or during a call. The camera cannot be adjusted when the system is in the menu screen.
- Ensure that the batteries in the remote control are in good working condition, and installed correctly.
- Aim the remote control at the sensor when you perform a task.
- Ensure that no objects are obstructing the sensor on the front of the camera.
- Ensure that the LED on the front of the camera flashes green when you use the remote control to perform a task.
- Ensure that what you are controlling is the local camera.
- Reboot the system.
- If the above suggestions cannot solve your problem, perhaps the remote control is broken. You can contact your system administrator for help.

Why is the video quality bad?

- Ensure that the display device has suitable resolution.
- Check whether the packet has been lost. For more information on packet loss, refer to [Call Statistics](#) on page 117.
- Contact your administrator to adjust the camera brightness and white balance.

Display Issues

Why is there no video on the display device?

- Ensure that the display device is turned on.
- Ensure that the display device is properly connected to VC800codec.
- Ensure that the VC800 video conferencing system is turned on.
- Ensure that you have selected the correct video input source.

Why can't the display device start presentation?

- Ensure that a PC is properly connected to the VC800 video conferencing system.



- Ensure that the PC is turned on.
- Ensure that the VCH50 video conferencing hub is not broken.
- Contact your administrator for help.

Video & Audio Issues

Why can't I hear the audio during a call?

- Ensure that the system has selected an available audio output device.
- If you select **VCS Phone** as the audio output device, ensure that the CP960 conference phone is connected to the VC800 codec, and LED indicators on the phone illuminate solid green.
- Ensure the proper volume level on the system.
- Ensure that the microphone on the remote system is not muted.

Why can't I hear a ring tone when receiving a call?

- Ensure that the system has selected an available audio output device.
- If you select **VCS Phone** as the audio output device, ensure that the CP960 conference phone is connected to the VC800 codec, and LED indicators on the phone illuminate solid green.
- Ensure that the ring volume is not set to 0. If it is, the  icon will appear on the status bar of the display device, and the  icon will appear on the CP960's touch screen.
- Adjust the ring volume when the system is idle via the remote control or CP960 conference phone. For more information, refer to [Volume Settings](#) on page 56.
- Ensure that the microphone of the remote system is not muted.

Why can't I hear the other site clearly during a call?

- Ensure that the speaker volume of the far site is not set too low.
- Muffled audio reception from the far side may be caused by highly reverberant rooms. Speak in close proximity to the phone.
- Adjust the priority order for your audio codec if you have chosen a low-bandwidth audio codec to be first.
- For best results, ensure that the caller is using a Yealink video conferencing system. Audio quality from your video conferencing system will vary when calling a non-Yealink system.
- Dust and debris may cause audio quality. Do not use any kind of liquid or aerosol cleaner on the phone. A soft, slightly damp cloth should be sufficient to clean the top surface of the phone if necessary.















Why is the voice quality poor?

Users may receive poor voice quality during a call, such as intermittent voice, low volume, echo or other noise. It is difficult to diagnosis the root causes of the voice anomalies. The possible reasons are:

- Users sit too far from or near to the microphone.
- The audio pickup device is moved frequently.
- Intermittent voice is probably caused by voice packet loss or jitter. Voice packet loss may occur due to network congestion. Jitter may occur due to information reorganization of the transmission or receiving equipment, such as, delay processing, retransmission mechanism or buffer overflow.
- Noise devices, such as computers or fans, may make it difficult to hear each other's voices clearly.
- Wires may also cause this problem. Replace the old with the new cables, and then reconnect to check whether the new cables provide better connectivity.

System Maintenance

To configure the site name via the remote control:

1. Select  (**More** menu).
2. Press  or  to scroll to **Setting** and then press  to expand the menu.
3. Press  or  to scroll to **Advanced** and then press .
4. Enter admin password (default password: 0000) in the **Password** field.
5. Press .
6. Press  or  to scroll to **Reboot & Reset** and then press .
7. Press  or  to scroll to **Reboot** and then press .

The display device prompts “Reboot the system?”.

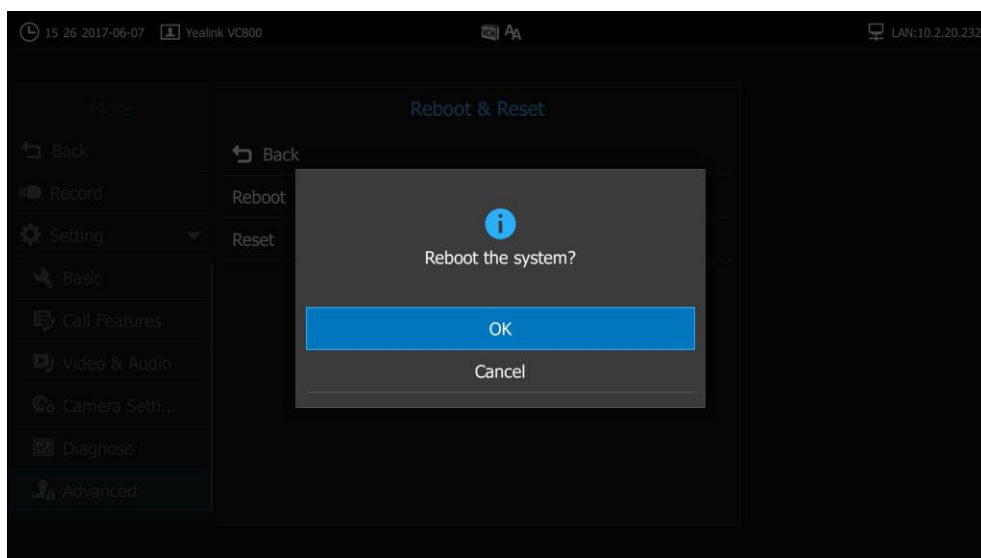

8. Select **OK**, and then press **OK**.

You can reboot the system via web user interface at the path **Setting->Upgrade->Reboot**.

How to export PCAP trace?

We may need you to provide a PCAP trace to help analyze your problem. Exporting PCAP trace is configurable via web user interface and remote control.

To capture packets via web user interface:

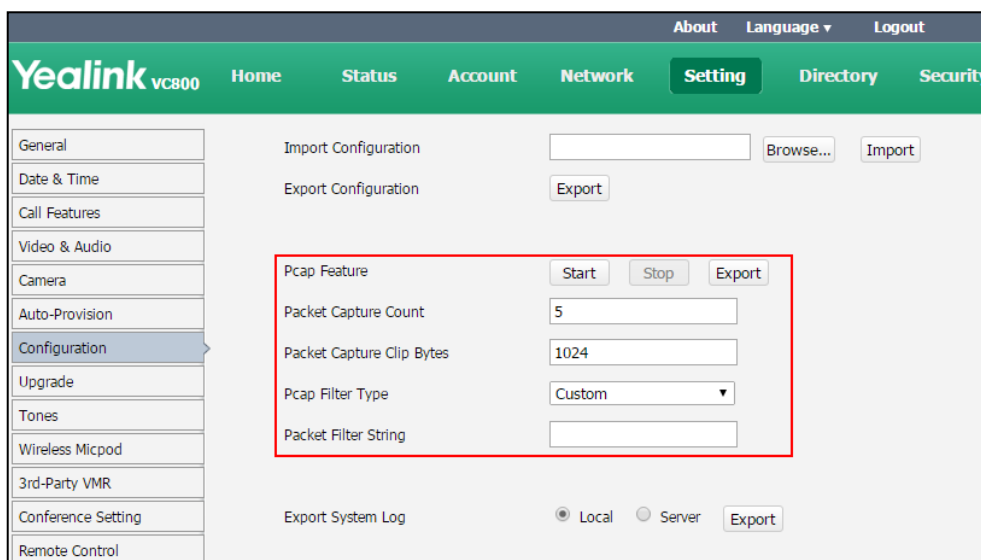

1. Click on **Setting->Configuration**.
2. Enter the desired value in the **Packet Capture Count** field.
3. Enter the desired value in the **Packet Capture Clip Bytes** field.
4. Select the desired value from the pull-down list of **Pcap Filter Type**.
If **Custom** is selected, enter the desired packet filter string in the **Packet Filter String** field.
5. Click **Start** to start capturing signal traffic.
6. Reproduce the issue to get stack traces.
7. Click **Stop** to stop capturing.

- Click **Export** to open the file download window, and then save the file to your local system.



To export a PCAP trace via remote control:

Before capturing packets, make sure a USB flash driver is connected to VC800 codec, VCH50 video conferencing hub or CP960 conference phone and the USB feature is enabled.

- Long press  when the system is idle or during a call.
The display device prompts "Onekey-capture has been turned on, press the Backspace key for 2s to turn off it".
- Long press  for 2 seconds to stop capturing packets.
The packets are saved in the yealink.debug folder on your USB flash driver.

How to export system log?

We may need you to provide your phone configurations to help analyze your problems. You can export the system log to the local system or designated log server.

To export the system log to a local PC via web user interface:

- Click on **Setting->Configuration**.
- Mark the **Local** radio box in the **Export System Log** field.
- Select **6** from the pull-down list of **System Log Level**.

The default system log level is 6.

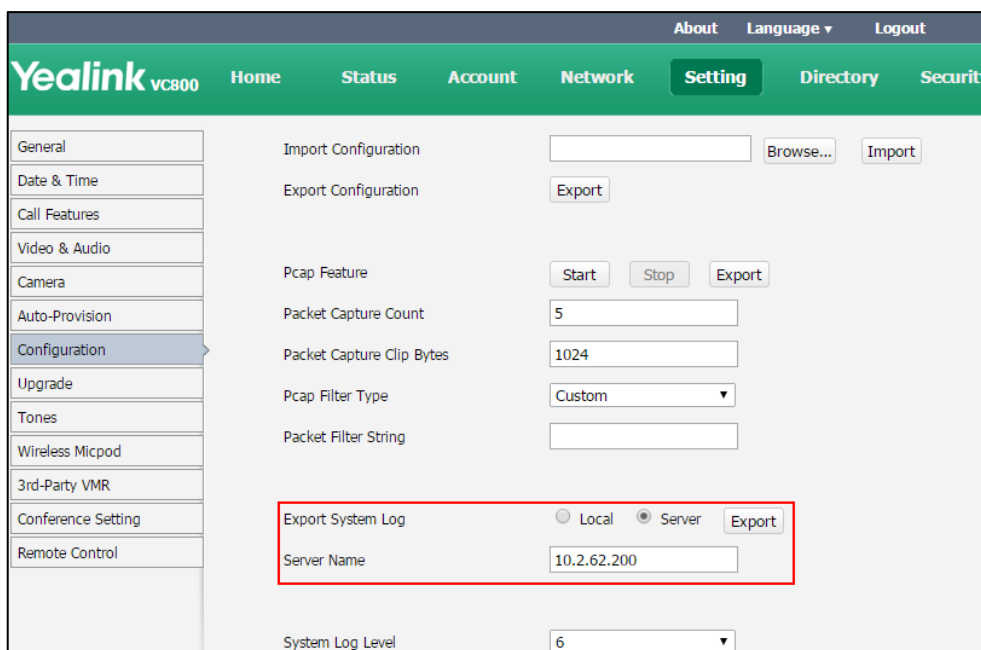

4. Click **Confirm** to accept the change.
The web user interface prompts "Operating...Please wait...".
Export the system log referring to the following steps.
5. Recreate the error to be documented in the trace.
6. Click **Export** to save the file to your local system.

How to export/import the system configurations?

We may need you to provide your system configurations to help analyze problems. In some instance, you may need to import configurations to your system.

To export the system configurations via web user interface:

1. Click on **Setting**->**Configuration**.
2. Click **Export**.
3. Click **Confirm** to export the configurations.

To import the system configurations via web user interface:

1. Click on **Setting**->**Configuration**.

2. Click **Browse** to locate a configuration file from your local system.

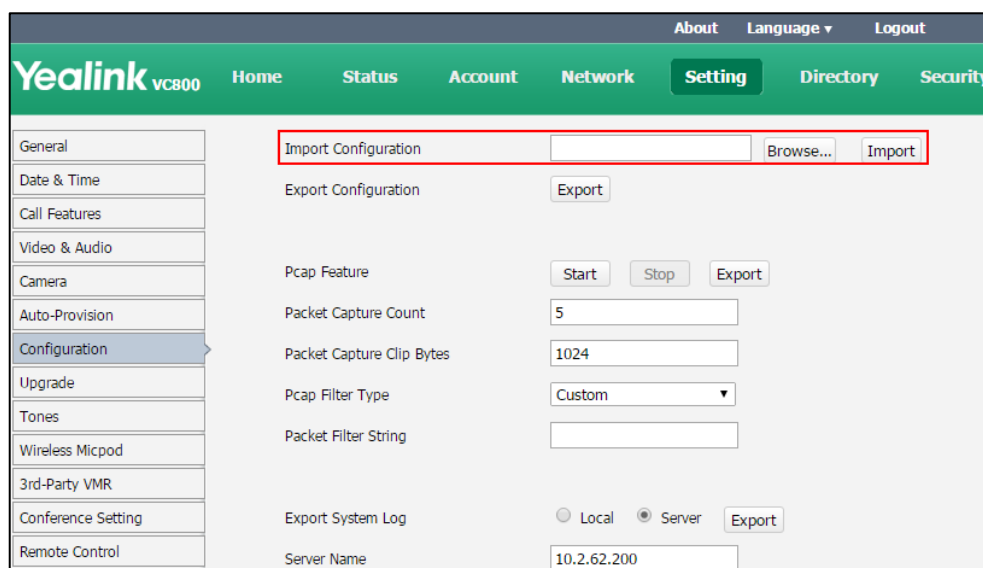

3. Click **Import** to import the configuration file.

Note

The file format of configuration file must be *.bin.

How to upgrade VC800 firmware?

To upgrade VC800 firmware via web user interface:

1. Click on **Setting**->**Upgrade**.
2. In the **Upgrade Firmware** field, click **Browse** to locate the VC800 firmware from your local system.

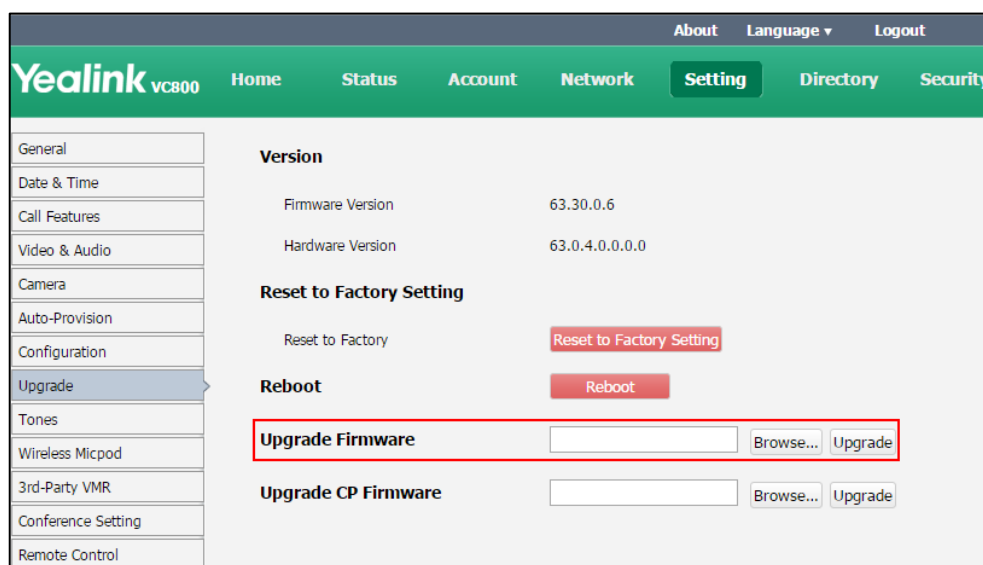

3. Click **Upgrade** to upgrade the firmware.

The browser pops up the dialog box "Firmware will be updated. It will take 5 minutes to

complete. Please don't power off!".

4. Click **Confirm** to confirm upgrading.

To upgrade CP960 firmware via web user interface:

1. Click on **Setting->Upgrade**.
2. In the **Upgrade CP Firmware** field, click **Browse** to locate the CP960 firmware from your local system.

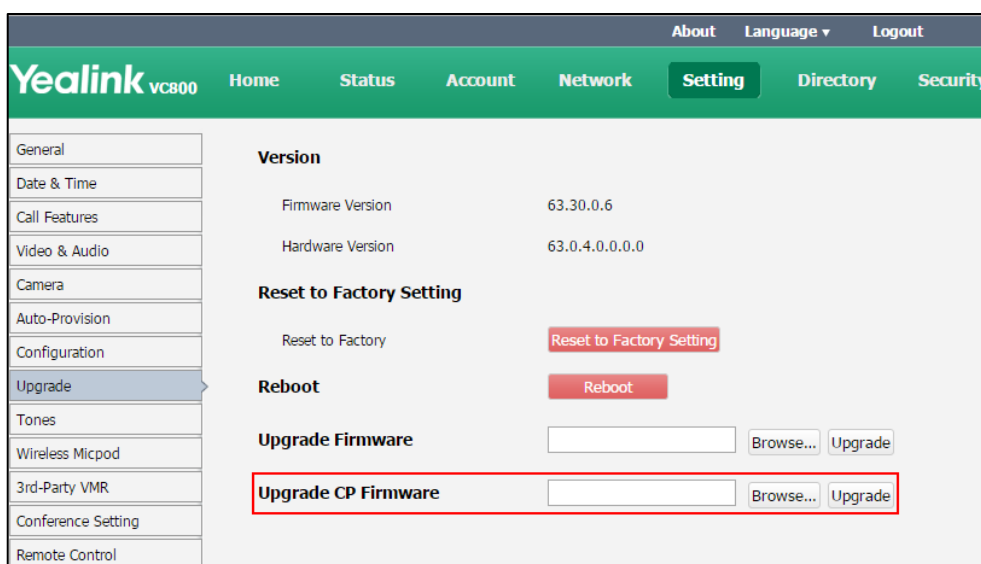















3. Click **Upgrade** to upgrade the firmware.
The browser pops up the dialog box "Firmware will be updated. It will take 5 minutes to complete. Please don't power off!".
4. Click **Confirm** to confirm upgrading.

How to reset the system?

Reset the system to factory configurations after you have tried all appropriate troubleshooting suggestions but have still do not solved the problem. You need to note that all customized settings will be overwritten after reset. You can reset the system via the remote control or web user interface.

To reset the system via the remote control:

1. Select  (**More** menu).
2. Press  or  to scroll to **Setting** and then press  to expand the menu.
3. Press  or  to scroll to **Advanced** and then press .
4. Enter admin password (default password: 0000) in the **Password** field.
5. Press .
6. Press  or  to scroll to **Reboot & Reset** and then press .
7. Press  or  to scroll to **Reset** and then press .

The display device prompts “Reset to Factory?”

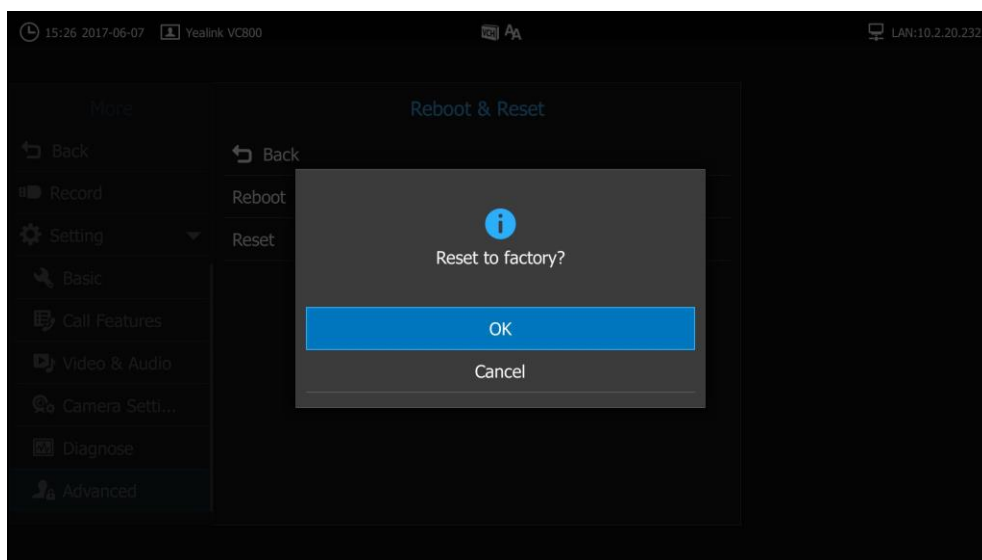

8. Select **OK**, and then press **OK**.

The system reboots automatically, The CP960's touch screen prompts “Rebooting Please wait...”. The phone will be reset to factory successfully after startup.

Note

Reset of the system may take a few minutes. Do not power off until the phone starts up successfully.

Resetting the system is configurable via web user interface at the path **Setting->Upgrade->Reset to Factory.**

Regulatory Notices

Service Agreements

Contact your Yealink Authorized Reseller for information about service agreements applicable to your product.

Limitations of Liability

TO THE FULL EXTENT ALLOWED BY LAW, YEALINK EXCLUDES FOR ITSELF AND ITS SUPPLIERS ANY LIABILITY, WHETHER BASED IN CONTRACT OR TORT (INCLUDING NEGLIGENCE), FOR INCIDENTAL, CONSEQUENTIAL, INDIRECT, SPECIAL, OR PUNITIVE DAMAGES OF ANY KIND, OR FOR LOSS OF REVENUE OR PROFITS, LOSS OF BUSINESS, LOSS OF INFORMATION OR DATA, OR OTHER FINANCIAL LOSS ARISING OUT OF OR IN CONNECTION WITH THE SALE, INSTALLATION, MAINTENANCE, USE, PERFORMANCE, FAILURE, OR INTERRUPTION OF ITS PRODUCTS, EVEN IF YEALINK OR ITS AUTHORIZED RESELLER HAS BEEN ADVISED OF THE POSSIBILITY OF SUCH DAMAGES, AND LIMITS ITS LIABILITY TO REPAIR, REPLACEMENT, OR REFUND OF THE PURCHASE PRICE PAID, AT YEALINK'S OPTION. THIS DISCLAIMER OF LIABILITY FOR DAMAGES WILL NOT BE AFFECTED IF ANY REMEDY PROVIDED HEREIN SHALL FAIL OF ITS ESSENTIAL PURPOSE.

Safety Instructions

Save these instructions. Read these safety instructions before use!

The following basic safety precautions should always be followed to reduce the risk of fire, electrical shock, and other personal injury.



General Requirements

- Before you install and use the device, read the safety instructions carefully and monitor the situation during operation.
- During the process of storage, transportation, and operation, please always keep the device dry and clean.
- During the process of storage, transportation, and operation, please avoid collision and an impact to the device.
- Please do not attempt to dismantle the device by yourself. In case of any discrepancy, please contact the appointed maintenance center for repair.
- Without prior written consent, no organization or individual is permitted to make any change to the structure or the safety design of the device. Yealink is under no circumstance liable to consequences or legal issues caused by such changes.
- Please refer to the relevant laws and statutes while using the device. The legal rights of others should be respected as well.

Environmental Requirements



- Place the device in a well-ventilated place. Do not expose the device to direct sunlight.
- Keep the device dry and free of dust.
- Place the device on a stable and level platform.
- Please do not place any heavy objects on the device in case of damage and deformation caused by the heavy load.
- Keep at least 10 cm between the device and the closest object for heat dissipation.
- Do not place the device on or near any inflammable or fire-vulnerable object, such as rubber-made materials.
- Keep the device away from any heat source or bare fire, such as a candle or an electric heater.
- Keep the device away from any household appliance with a strong magnetic field or electromagnetic field, such as a microwave oven or a refrigerator.



Operating Requirements

- Do not let a child operate the device without guidance.
- Do not let a child play with the device or any accessory in case of accidental swallowing.
- Please only use accessories provided or authorized by the manufacturer only.
- The power supply of the device shall meet the requirements of the input voltage of the device. Please only use the surge protection power socket provided.
- Before plugging or unplugging any cable, ensure that your hands are completely dry.
- Do not spill liquid of any kind on the product or use the equipment near water, for example, near a bathtub, washbowl, kitchen sink, wet basement or near a swimming pool.
- Do not tread on, pull, or over-bend any cable in case of malfunction of the device.
- During a thunderstorm, stop using the device and disconnect it from the power supply. Unplug the power plug and the Asymmetric Digital Subscriber Line (ADSL) twisted pair (the radio frequency cable) to avoid lightning strike.
- If the device is left unused for a rather long time, disconnect it from the power supply and unplug the power plug.
- When smoke or an abnormal noise or smell is emitted from the device, disconnect the device from the power supply, and unplug the power plug immediately. Contact the specified maintenance center for repair.
- Do not insert any object into equipment slots that is not part of the product or auxiliary product.
- Before connecting a cable, connect the grounding cable of the device first. Do not disconnect the grounding cable until you disconnect all other cables.



Cleaning Requirements

- Before cleaning the device, stop using it and disconnect it from the power supply.
- Use a piece of soft, dry and anti-static cloth to clean the device.

- Keep the power plug clean and dry. Using a dirty or wet power plug may lead to electric shock or other perils.

Restriction of Hazardous Substances

Restriction of Hazardous Substances (RoHS) is a Chinese government regulation which aims to restrict certain dangerous substances commonly used in electronic and electronic equipment.

The following table lists the names and content of toxic and hazardous substances or elements probably contained in the products:

Parts Name	Toxic or Hazardous Substance and Elements					
	Lead (Pb)	Mercury (Hg)	Cadmium (Cd)	Hexavalent Chromium (Cr ⁺⁶)	Polybrominated Biphenyls (PBB)	Polybrominated Diphenyl Ethers (PBDE)
Plastic and Polymeric Parts	O	O	O	O	O	O
Metal Parts	X	O	O	O	O	O
PCBA	X	O	O	O	O	O
Cables and Cable Assemblies	O	O	O	O	O	O
LCD Screen	O	O	O	O	O	O
Batteries	O	O	O	O	O	O
Packing Material	O	O	O	O	O	O

O: Indicates that toxic substances contained in all homogeneous materials in this product are below the limit requirement in GB/T26572-2011 standard.

X: Indicates that toxic substances contained in all homogeneous materials in this product are above the limit requirement in GB/T26572-2011 standard.

This table lists the toxic and hazardous substances contained in the machine. Based on the material type, the data is provided by the supplier and has already been validated by Yealink company.

Some harmful substances contained in the material cannot be replaced according to the current technology. We constantly strive to improve our products.

Appendix A - Time Zones

Time Zone	Time Zone Name
-11:00	Samoa
-10:00	United States-Hawaii-Aleutian
-10:00	United States-Alaska-Aleutian
-09:30	French Polynesia
-09:00	United States-Alaska Time
-08:00	Canada(Vancouver, Whitehorse)
-08:00	Mexico(Tijuana, Mexicali)
-08:00	United States-Pacific Time
-07:00	Canada(Edmonton, Calgary)
-07:00	Mexico(Mazatlan, Chihuahua)
-07:00	United States-Mountain Time
-07:00	United States-MST no DST
-06:00	Canada-Manitoba(Winnipeg)
-06:00	Chile(Easter Islands)
-06:00	Mexico(Mexico City, Acapulco)
-06:00	United States-Central Time
-05:00	Bahamas(Nassau)
-05:00	Canada(Montreal, Ottawa, Quebec)
-05:00	Cuba(Havana)
-05:00	United States-Eastern Time
-04:30	Venezuela(Caracas)
-04:00	Canada(Halifax, Saint John)
-04:00	Chile(Santiago)
-04:00	Paraguay(Asuncion)
-04:00	United Kingdom-Bermuda(Bermuda)
-04:00	United Kingdom(Falkland Islands)
-04:00	Trinidad&Tobago
-03:30	Canada-New Foundland(St.Johns)
-03:00	Denmark-Greenland(Nuuk)
-03:00	Argentina(Buenos Aires)
-03:00	Brazil(no DST)
-03:00	Brazil(DST)
-02:30	Newfoundland and Labrador
-02:00	Brazil(no DST)
-01:00	Portugal(Azores)
0	GMT

Time Zone	Time Zone Name
0	Greenland
0	Denmark-Faroe Islands(Torshavn)
0	Ireland(Dublin)
0	Portugal(Lisboa, Porto, Funchal)
0	Spain-Canary Islands(Las Palmas)
0	United Kingdom(London)
0	Morocco
+01:00	Albania(Tirane)
+01:00	Austria(Vienna)
+01:00	Belgium(Brussels)
+01:00	Caicos
+01:00	Chad
+01:00	Spain(Madrid)
+01:00	Croatia(Zagreb)
+01:00	Czech Republic(Prague)
+01:00	Denmark(Kopenhagen)
+01:00	France(Paris)
+01:00	Germany(Berlin)
+01:00	Hungary(Budapest)
+01:00	Italy(Rome)
+01:00	Luxembourg(Luxembourg)
+01:00	Macedonia(Skopje)
+01:00	Netherlands(Amsterdam)
+01:00	Namibia(Windhoek)
+01:00	Poland (Warsaw)
+02:00	Estonia(Tallinn)
+02:00	Finland(Helsinki)
+02:00	Gaza Strip(Gaza)
+02:00	Greece(Athens)
+02:00	Israel(Tel Aviv)
+02:00	Jordan(Amman)
+02:00	Latvia(Riga)
+02:00	Lebanon(Beirut)
+02:00	Moldova(Kishinev)
+02:00	Russia(Kaliningrad)
+02:00	Romania(Bucharest)
+02:00	Syria(Damascus)
+02:00	Turkey(Ankara)
+02:00	Ukraine(Kyiv, Odessa)
+03:00	East Africa Time
+03:00	Iraq(Baghdad)

Time Zone	Time Zone Name
+03:00	Russia(Moscow)
+03:30	Iran(Teheran)
+04:00	Armenia(Yerevan)
+04:00	Azerbaijan(Baku)
+04:00	Georgia(Tbilisi)
+04:00	Kazakhstan(Aktau)
+04:00	Russia(Samara)
+04:30	Afghanistan(Kabul)
+05:00	Kazakhstan(Aqtobe)
+05:00	Kyrgyzstan(Bishkek)
+05:00	Pakistan(Islamabad)
+05:00	Russia(Chelyabinsk)
+05:30	India(Calcutta)
+05:45	Nepal(Katmandu)
+06:00	Kazakhstan(Astana, Almaty)
+06:00	Russia(Novosibirsk, Omsk)
+06:30	Myanmar(Naypyitaw)
+07:00	Russia(Krasnoyarsk)
+07:00	Thailand(Bangkok)
+08:00	China(Beijing)
+08:00	Singapore(Singapore)
+08:00	Australia(Perth)
+08:00	Russia(Irkutsk, Ulan-Ude)
+08:45	Eucla
+09:00	Korea(Seoul)
+09:00	Japan(Tokyo)
+09:00	Russia(Yakutsk, Chita)
+09:30	Australia(Adelaide)
+09:30	Australia(Darwin)
+10:00	Australia(Sydney, Melbourne, Canberra)
+10:00	Australia(Brisbane)
+10:00	Australia(Hobart)
+10:00	Russia(Vladivostok)
+10:30	Australia(Lord Howe Islands)
+11:00	New Caledonia(Noumea)
+11:00	Russia(Srednekolymsk Time)
+11:30	Norfolk Island
+12:00	New Zealand(Wellington, Auckland)
+12:00	Russia(Kamchatka Time)
+12:45	New Zealand(Chatham Islands)
+13:00	Tonga(Nukualofa)

Time Zone	Time Zone Name
+13:30	Chatham Islands
+14:00	Kiribati

Index

A

- About This Guide [v](#)
- Account Polling [91](#)
- Adding a Local Contact from the Call History List [82](#)
- Adding Contacts [64](#)
- Adjusting Zoom Level of the Display Device [55](#)
- Answering or Rejecting Calls [110](#)
- Appendix A - Time Zones [201](#)
- Audio Input Device [88](#)
- Audio Output Device [86](#)
- Audio Setting [86](#)
- Auto Answer [110](#)
- Automatic Sleep Time [45](#)

B

- Backlight [46](#)
- Bandwidth Settings [85](#)

C

- Call History Management [76](#)
- Call Management [116](#)
- Call Mute [116](#)
- Call Protocol [84](#)
- Call Statistics [117](#)
- Camera Issues [187](#)
- Chapters in This Guide [v](#)
- Charging the CPW90 [179](#)
- Changing the Video Input Source [118](#)
- Changing Video Layout [132](#)
- Conference Management [102](#)
- Conference Type [102](#)
- Configuring Camera Presets [120](#)
- Connecting CPW90 to the VC800 video Conferencing System [175](#)
- Connecting the Audio Device [23](#)
- Connecting the VC800 codec [22](#)

- Connecting the VC800 video conferencing system [21](#)
- Controlling Local Camera [29](#)
- Controlling the Remote Camera [89](#)
- CP960 Conference phone [9](#)
- CP960+CPW90 Package [3](#)
- CP960+CPE90 Package [4](#)
- CPE90 Wired Expansion Mic
- CPW90 Wireless Conferencing Microphone [11](#)
- CPW90 Working Frequency [179](#)
- Custom Key Type [61](#)
- Customizing the VC800 video conferencing system [45](#)

D

- Declaration of Conformity [vi](#)
- Deleting an Entry from the Call History List [80](#)
- Deleting Contacts [69](#)
- Directory [62](#)
- Display Issues [188](#)
- Dialing Pexip Alias [166](#)
- Dialing StarLeaf Cloud Numbers [160](#)
- Dialing Yealink Cloud Numbers [139](#)
- Documentations [vi](#)
- Do Not Disturb (DND) [112](#)
- Dual Display Screen Layouts [134](#)

E

- Editing Contacts [68](#)
- Editing Number before Calling [108](#)
- Ending Calls [114](#)
- Entering Data and Editing Fields [35](#)
- Entering Data and Editing Fields Using CP960 [37](#)
- Entering Data and Editing Fields Using Remote Control [35](#)

F

Far Control Near Camera [89](#)

G

General Issues [186](#)

General Settings [45](#)

Getting Started [1](#)

H

Hiding Icons in a Call [59](#)

Hiding IP Address [59](#)

Hiding Heading Time [59](#)

I

Icon Instructions [15](#)

Icons on CP960 Conference phone [17](#)

Icons on Display Device [15](#)

Idle Screen [29](#)

Idle Screen of CP960 Conference phone [31](#)

Idle Screen of VC800 video conferencing system
[30](#)

Importing/Exporting Local Contact Lists [74](#)

Initiating a Conference [99](#)

Initiating a Conference by Dialing a Group [99](#)

Initiating a Conference by Inviting Participants
[101](#)

Installing Batteries for the Remote Control [21](#)

Installing the VC800 video Conferencing System
[24](#)

J

Joining a Scheduled Conference [146](#)

Joining the BlueJeans Meeting [165](#)

Joining the Meeting [106](#)

Joining the Mind Meeting [169](#)

Joining the Pexip Meeting [166](#)

Joining the StarLeaf Meeting [160](#)

Joining the Zoom Meeting [163](#)

K

Keyboard Input Method [36](#)

Key Tone [54](#)

L

Language [49](#)

LED Instructions [15](#)

Limitations of Liability [197](#)

M

Meet Now [152](#)

Meeting Blacklist [107](#)

Meeting Password [104](#)

Meeting Whitelist [106](#)

Mounting the VC800 codec on a TV [24](#)

Mounting the VC800 codec on a Wall [25](#)

Multipoint License [93](#)

Muting or Unmuting the CPW90 [177](#)

N

Navigating Menus and Fields [32](#)

Navigating the CP960 Conference phone [32](#)

Navigating the Display Device [32](#)

Network Quality Tip [117](#)

O

Overview [1](#)

P

Packaging Contents [1](#)

Phone Package [1](#)

Placing a Call from the Call History List [79](#)

Placing a Call Using the CP960 conference
phone [97](#)

Placing a Call Using the Remote Control [97](#)

Placing a Call via Web User Interface [99](#)

Placing Calls [91](#)

Placing Calls to Contacts [66](#)

Place Multiple Calls [99](#)

Placing the CPW90 [173](#)

Powering the System On [26](#)

Powering the System Off [28](#)

Presentation [119](#)

Put the System to Sleep 27

R

Registration 29

Regulatory Notices 197

Restriction of Hazardous Substances 199

Remote Control 20

Remote Control Battery Safety Information 26

S

Scheduled Conference 142

Screen Saver 48

Screenshot 129

Searching for Contacts 71

Search Source List in Dialing 72

Service Agreements 197

Setup Wizard 28

Site Name 48

System Component Instructions 5

System Diagnostics 183

System Maintenance 190

System Status 35

T

Table of Contents v

Terms vii

Time & Date 50

Troubleshooting 139

Turning the CPW90 On or Off 174

Typographic Conventions vii

U

USB Configuration 62

User Interfaces 18

Using the BlueJeans Cloud Platform 165

Using the CPW90 Wireless Expansion Mic 173

Using the Custom Platform 169

Using the Mind Platform 169

Using the Pexip Platform 166

Using the StarLeaf Cloud Platform 160

Using the VC800 video conferencing system 91

Using the Yealink VC Cloud Management

Service platform 139

Using the Yealink VC Cloud Management

Service Platform 139

Using the Zoom Cloud Platform 163

V

VC800 Codec 5

VC800 Package 1

VCH50 Video Conferencing Hub 7

VCR11 Remote Control 12

Video & Audio Issues 189

Video Conference Platform 139

Video Layout 131

Video Recording 125

Viewing Call History 77

Viewing CPW90 Information 177

Virtual Remote Control 20

Volume Settings 55

W

Website Snapshot 55

Web User Interface 19