

## Professional IP Phone with 3 Lines & HD Voice

Yealink SIP-T23G features intuitive user interface and enhanced functionality which make it easy for people to interact and maximize productivity. Yealink HD technology enables rich, clear, life-like voice communications, outsourced management options, flexible deployment and third-party communications applications. As a cost-effective IP solution, it helps users to streamline business processes, delivery a powerful, security and consistent communication experience for small and large offices environment.



### Key Features and Benefits

#### HD Audio

Yealink HD voice refers to the combination of software and hardware design as well as the implementation of wideband technology to maximize the acoustic performance. Coupled with advanced acoustic clarity technology such as full duplex, echo cancellation, adaptive jitter buffer etc., the SIP-T23G provides clearer, more lifelike voice communications.

#### Enhanced Call Management

The SIP-T23G supports vast productivity-enhancing features such as XML Browser, call park, call pickup, BLF, call forward, call transfer, 3-way conference, which makes it the natural and obvious efficiency tool for today's busy small and large offices environment.

#### Efficient Installation and Provisioning

The Yealink SIP-T23G supports efficient provisioning and effortless mass deployment with Yealink's Redirection and Provisioning Service (RPS) and Boot mechanism to help you realize the Zero Touch Provisioning without any complex manual settings, which makes the SIP-T23G simple to deploy, easy to maintain and upgrade.

#### Highly secure transport and interoperability

The communicator uses SIP over Transport Layer Security (TLS/SSL) to provide service providers with the latest technology for enhanced network security. The range is certified compatible with 3CX and Broadsoft Broadworks, ensuring excellent compatibility with leading soft switch suppliers.

- > Yealink HD Voice
- > Dual-port Gigabit Ethernet
- > PoE support
- > 132 x 64-pixel graphical LCD
- > Up to 3 SIP accounts
- > Opus codec support
- > Supports Dual-color LEDs
- > Headset support
- > Wall mountable
- > IPv6 support
- > Paperless design
- > Simple, flexible and secure provisioning options

### Audio Features

- > HD voice: HD handset, HD speaker
- > Wideband codec: AMR-WB (optional), Opus, G.722
- > Narrowband codec: G.711(A/μ), G.729, G.726, iLBC
- > DTMF: In-band, Out-of-band (RFC 2833) and SIP INFO
- > Full-duplex hands-free speakerphone with AEC
- > VAD, CNG, AEC, PLC, AJB, AGC

### Phone Features

- > 3 SIP accounts
- > Call hold, mute, DND
- > One-touch speed dial, hotline
- > Call forward, call waiting, call transfer
- > Group listening, SMS
- > Redial, call return, auto answer
- > Local 3-way conferencing
- > Direct IP call without SIP proxy
- > Ring tone selection/import/delete
- > Set date time manually or automatically
- > Dial plan, off hook hot line
- > XML Browser, Action URL/URI
- > Integrated screenshots
- > RTCP-XR, VQ-RTCPXR
- > Enhanced DSS Key

### Directory

- > Local phonebook up to 1000 entries
- > Black list
- > XML/LDAP remote phonebook
- > Smart dialing
- > Phonebook search/import/export
- > Call history: dialed/received/missed/forwarded

### IP-PBX Features

- > Busy Lamp Field (BLF), Bridged Line Appearance(BLA)
- > Anonymous call, anonymous call rejection
- > Hot-desking, emergency call
- > Message Waiting Indicator (MWI)
- > Voice mail, call park, call pickup
- > Intercom, paging, music on hold
- > Call completion, call recording
- > Flexible seating
- > Executive and Assistant
- > Centralized call recording
- > Visual voice mail

### Display and Indicator

- > 132 x 64-pixel graphical LCD with backlight
- > LED for call and message waiting indication
- > Dual-color (red or green) illuminated LEDs for line status information
- > Intuitive user interface with icons and soft keys
- > Multilingual user interface
- > Caller ID with name and number
- > Power saving

### Feature keys

- > 3 line keys with LED
- > 5 features keys: message, headset, redial, tran, hands-free speakerphone
- > 6 navigation keys
- > Volume control keys

### Interface

- > Dual-port Gigabit Ethernet
- > Power over Ethernet (IEEE 802.3af), class 2
- > 1 x RJ9 (4P4C) handset port
- > 1 x RJ9 (4P4C) headset port

### Other Physical Features

- > Color: Black
- > Wall mountable
- > External Yealink AC adapter (optional): AC 100~240V input and DC 5V/600mA output
- > Power consumption (PSU): 0.7-1.5W
- > Power consumption (PoE): 1.0-2.2W
- > Dimension (W\*D\*H\*T): 209mm\*188mm\*150mm\*41mm
- > Operating humidity: 10~95%
- > Operating temperature: -10~50°C (+14~122°F)

### Management

- > Configuration: browser/phone/auto-provision
- > Auto provision via FTP/TFTP/HTTP/HTTPS for mass deploy
- > Auto-provision with PnP
- > Zero-sp-touch, TR-069
- > Phone lock for personal privacy protection
- > Reset to factory, reboot
- > Package tracing export, system log

### Network and Security

- > SIP v1 (RFC2543), v2 (RFC3261)
- > Call server redundancy supported
- > NAT traversal: STUN mode
- > Proxy mode and peer-to-peer SIP link mode
- > IP assignment: static/DHCP
- > HTTP/HTTPS web server
- > Time and date synchronization using SNTP
- > UDP/TCP/DNS-SRV (RFC 3263)
- > QoS: 802.1p/Q tagging (VLAN), Layer 3 ToS DSCP
- > SRTP for voice
- > Transport Layer Security (TLS)
- > HTTPS certificate manager
- > AES encryption for configuration file
- > Digest authentication
- > OpenVPN, IEEE802.1X
- > IPv6
- > LLDP/CDP/DHCP VLAN
- > ICE

### Package Features

- > Package content:
  - Yealink SIP-T23G IP phone
  - Handset with handset cord
  - Ethernet Cable (1.5m CAT5E UTP Cable)
  - Stand
  - Quick Start Guide
  - Power Adapter (Optional)
- > Qty/CTN: 10 PCS
- > N.W/CTN: 11.3 kg
- > G.W/CTN: 12.6 kg
- > Giftbox size: 215mm\*200mm\*118mm
- > Carton Meas: 615mm\*436mm\*208mm

### Compliance

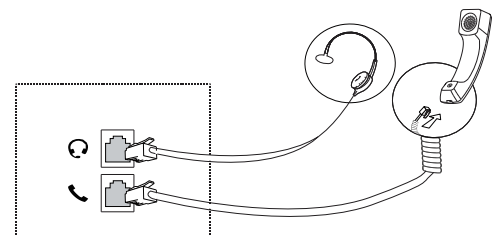
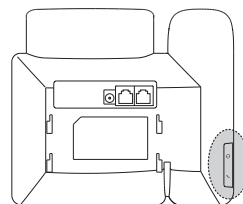
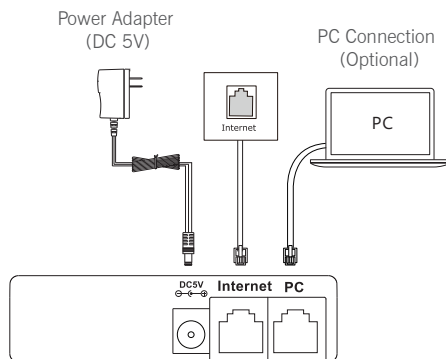

### Learn More

To find out how Yealink solutions can help your organization, visit us at [www.yealink.com](http://www.yealink.com) or mail to [sales@yealink.com](mailto:sales@yealink.com)

# Yealink

## About Yealink

Yealink is a global leading provider of enterprise communication and collaboration solutions, offering video conferencing service to worldwide enterprises. Focusing on research and development, Yealink also insists on innovation and creation. With the outstanding technical patents of cloud computing, audio, video and image processing technology, Yealink has built up a panoramic collaboration solution of audio and video conferencing by merging its cloud services with a series of endpoints products. As one of the best providers in more than 140 countries and regions including the US, the UK and Australia, Yealink ranks No.1 in the global market share of SIP phone shipments.

## Copyright

Copyright © 2018 YEALINK(XIAMEN) NETWORK TECHNOLOGY CO., LTD.

Copyright © 2018 Yealink(Xiamen) Network Technology CO., LTD. All rights reserved. No parts of this publication may be reproduced or transmitted in any form or by any means, electronic or mechanical, photocopying, recording, or otherwise, for any purpose, without the express written permission of Yealink(Xiamen) Network Technology CO., LTD.

## Technical Support

Visit Yealink WIKI (<http://support.yealink.com/>) for firmware downloads, product documents, FAQ, and more. For better service, we sincerely recommend you to use Yealink Ticketing system (<https://ticket.yealink.com>) to submit all your technical issues.



YEALINK(XIAMEN) NETWORK TECHNOLOGY CO.,LTD.  
Web: [www.yealink.com](http://www.yealink.com)  
Addr: No.1 Ling-Xia North Road, High Tech Park,  
Huli District, Xiamen, Fujian, P.R. China  
Copyright©2018Yealink Inc. All right reserved.