

## All-in-One Android Video Collaboration Bar for Small and Huddle Rooms

Yealink MeetingBar A20, an all-in-one video collaboration bar for small and huddle rooms. Featuring 20MP camera and 133° super-wide-angle lens, A20 delivers outstanding video quality. Together with the electric lens cap, its AI technologies including Auto Framing and Speaker Tracking and so on, allow users to experience a smarter and safer video conference. With 8 MEMS microphone arrays and Yealink noise proof technology, A20 brings excellent audio experience in small rooms even in full-duplex mode and ensures that everyone can be heard as well as seen. Moreover, A20 combines computing unit, camera, microphones, speaker, Wi-Fi, and Bluetooth, which provides you a solution of simple deployment. A20 is capable of content sharing that making the meeting more communicative and collaborative. Simple and flexible deployment but powerful features deliver excellent video collaboration performance.



Qualcomm SD845 chipset



20MP Camera



Super Wide FoV



Electric Privacy Shutter



Dual Screen



Auto Framing



Speaker Tracking



All in One Design



## Key Features and Benefits

### Smart Video Collaboration

Based on Android 9.0 OS, A20 owns native RingCentral experience that all features can be operated by just one touch or by the remote controller. Meanwhile, A20 supports content sharing that making the meeting more communicative and collaborative.

### See Everyone Clearly

Equipped with Qualcomm Snapdragon 845, A20 has strong image processing, encoding and decoding capabilities. Besides, with its 20 MP camera can provide a high-quality video conference experience. With super-wide 133° field of view, everyone in the conference can be seen without adjusting the camera. Moreover, the image brightness can be automatically optimized even in a dim or backlight environment, ensuring the participant faces can be seen clearly.

### Smart Video Conferencing with AI Technology

Featuring AI technology, including Auto Framing and Speaker Tracking, A20 not only supports framing the groups automatically according to the number and the position of the participants, but also automatically zoom in the speaker without adjusting the camera, making the participants more focus on the conference.









### Precise Sound Localization, Full-Duplex Experience

8 MEMS microphone arrays make A20 have stronger ability of noise proof and dereverberation. The new upgraded beamforming algorithm, together with technology of processing on acoustic echo cancellation and the dereverberation, brings high quality full-duplex call and realizes more precise voice pickup.

### All-in-one Design for Fast Start

Integrating computing unit, camera, microphones, speaker, Bluetooth, Wi-Fi and bracket, A20 takes up less space and minimizing cable clutter. For your easy deployment, it is ready for a video conference by simply plugging in the power adapter and HDMI cable. In addition, the Yealink Device Management ensures an easy management to you.

- Qualcomm Snapdragon 845 chipset
- ALL-IN-ONE design
- 20MP camera
- 133° Super filed of view
- Electric Privacy Shutter
- Dual screen
- Auto framing and speaker tracking
- Built-in Bluetooth
- Built-in dual-band Wi-Fi
- Content sharing

<p><b>Camera</b></p> <ul style="list-style-type: none"> <li>• 20MP Camera</li> <li>• 133° field of view</li> <li>• 8x e-PTZ camera</li> <li>• Electric privacy shutter</li> <li>• Intelligence Features             <ul style="list-style-type: none"> <li>- Auto Framing</li> <li>- Speaker Tracking</li> </ul> </li> </ul> <p><b>Audio</b></p> <ul style="list-style-type: none"> <li>• Built-in 8 MEMS microphone array</li> <li>• Built-in 5W high fidelity speaker</li> <li>• Yealink Noise Proof Technology</li> <li>• Full-duplex</li> <li>• Echo cancellation</li> </ul> <p><b>Operating System</b></p> <ul style="list-style-type: none"> <li>• Android 9.0</li> </ul> <p><b>Video Standard and Network Suitability</b></p> <ul style="list-style-type: none"> <li>• Video codecs: H.264 High profile, H.264 SVC, H.264</li> </ul> <p><b>Network and Security Features</b></p> <ul style="list-style-type: none"> <li>• Built-in dual-band Wi-Fi (2.4GHz/5GHz)</li> <li>• Built-in Bluetooth</li> <li>• IPv4 and IPv6, DHCP/static IP</li> <li>• HTTP/HTTPS web server</li> <li>• SRTP/TLS, AES 256-bit encryption</li> </ul>	<ul style="list-style-type: none"> <li>• QoS: 802.1p/q, Diff-serv</li> <li>• VLAN, LLDP</li> <li>• IEEE802.1X             <ul style="list-style-type: none"> <li>- EAP-MD5/EAP-TLS</li> <li>- PEAP-MSCHAPv2</li> <li>- EAP-TTLS/EAP-MSCHAPv2</li> </ul> </li> <li>• Network diagnosis: Ping, Trace route</li> <li>• Time and date synchronization using SNTP</li> <li>• Built-in certificate</li> <li>• Simple Certificate Enrollment Protocol (SCEP)             <ul style="list-style-type: none"> <li>* coming soon</li> </ul> </li> </ul> <p><b>Connections</b></p> <ul style="list-style-type: none"> <li>• 2 x HDMI output (CEC supported)</li> <li>• HDMI input (through the VCH51 Sharing Kit)</li> <li>• 1 x USB 2.0</li> <li>• 1 x 10/100M/1000M Ethernet port</li> <li>• 1 x Yealink VCH port (RJ-45)</li> <li>• 1 x Power port</li> <li>• 1 x Security lock slot</li> <li>• 1 x Reset slot</li> </ul> <p><b>Other Physical Features</b></p> <ul style="list-style-type: none"> <li>• Storage: built-in 64 GB (Available: 40G)</li> <li>• Chipset: Qualcomm Snapdragon 845 chipset</li> <li>• Power Adapter: AC 100~240V input</li> <li>• USB Output: 5V <math>\equiv</math> 0.5A</li> <li>• Power consumption (PSU):             <ul style="list-style-type: none"> <li>Idle &lt; 10W; Normal operating: 10.5W; MAX: 14W</li> </ul> </li> </ul>	<ul style="list-style-type: none"> <li>• Dimension (W.D.H): 600 mm x 68 mm x 82 mm</li> <li>• Operating humidity: 10~95%</li> <li>• Operating temperature: 0~40°C</li> <li>• Storage temperature: -30~70°C</li> </ul> <p><b>MeetingBar A20 Package</b></p> <ul style="list-style-type: none"> <li>• Package contents:             <ul style="list-style-type: none"> <li>- MeetingBar A20 endpoint</li> <li>- 3m Ethernet cable</li> <li>- 2 x 1.8m HDMI cable</li> <li>- Mounting Bracket and Accessories</li> <li>- Power adapter</li> <li>- Quick Start Guide</li> <li>- Controller (optional):                 <ul style="list-style-type: none"> <li>CTP18 Touch Panel</li> <li>VCR20 Remote Control</li> </ul> </li> <li>- Content sharing(optional):                 <ul style="list-style-type: none"> <li>VCH51 Sharing Kit (HDMI/USB-C)</li> <li>WPP20 Wireless Presentation Pod</li> </ul> </li> </ul> </li> <li>• Carton Meas: 674*136*195mm</li> </ul> <p><b>MeetingBar A20 + CTP18 Package</b></p> <ul style="list-style-type: none"> <li>• Carton Meas: 685*293*215mm</li> </ul> <p><b>Compliance</b></p> <p>      </p> <p>    </p>
--	---	--

## Endpoint Connections

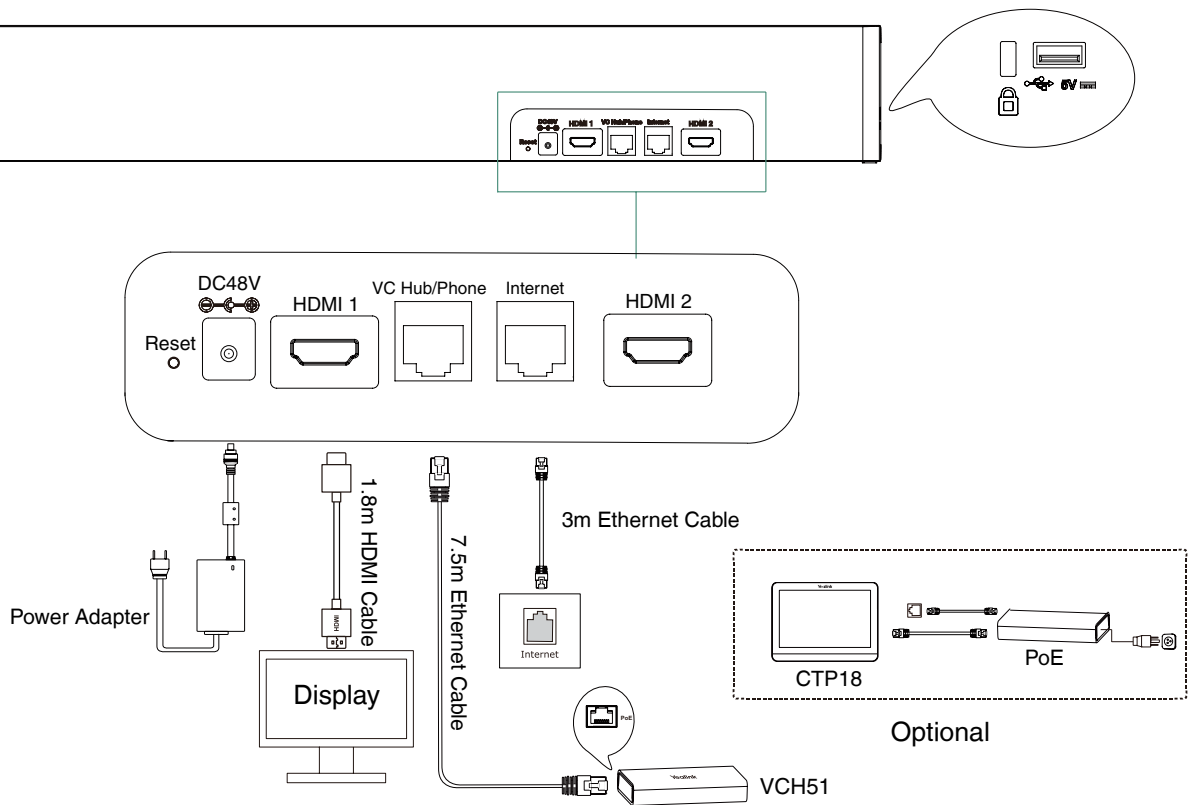

### Note:

- If you connect a touch display device, you can operate the A20 either by remote control or touch control.
- If you connect a non-touch display device, you can use the remote control, mouse or CTP18.

## About Yealink

Yealink (Stock Code: 300628) is a global brand that specializes in video conferencing, voice communications and collaboration solutions with best-in-class quality, innovative technology and user-friendly experience. As one of the best providers in more than 140 countries and regions, Yealink ranks No.1 in the global market share of SIP phone shipments (Global IP Desktop Phone Growth Excellence Leadership Award Report, Frost & Sullivan, 2019).

## Copyright

Copyright © 2021 YEALINK(XIAMEN) NETWORK TECHNOLOGY CO., LTD.

All rights reserved. No parts of this publication may be reproduced or transmitted in any form or by any means, electronic or mechanical, photocopying, recording, or otherwise, for any purpose, without the express written permission of Yealink(Xiamen) Network Technology CO., LTD.

## Technical Support

Visit Yealink WIKI (<http://support.yealink.com/>) for firmware downloads, product documents, FAQ, and more. For better service, we sincerely recommend you to use Yealink Ticketing system (<https://ticket.yealink.com>) to submit all your technical issues.



YEALINK(XIAMEN) NETWORK TECHNOLOGY CO.,LTD.  
Web: [www.yealink.com](http://www.yealink.com)  
Addr: No.1 Ling-Xia North Road, High Tech Park,  
Huli District, Xiamen, Fujian, P.R.C  
Copyright©2021 Yealink Inc. All right reserved.